

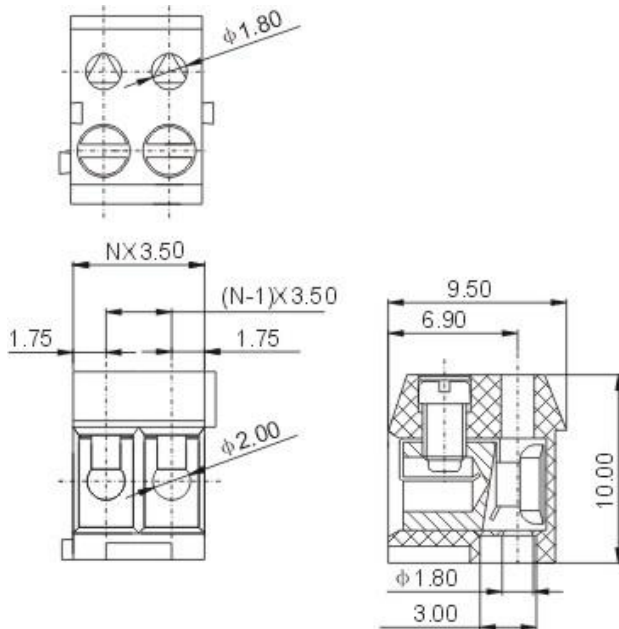





**DG333K-3.5**

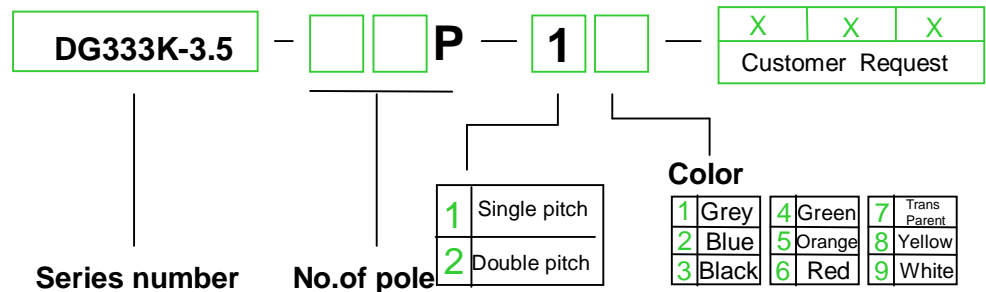

<b>APPROVAL</b>		
<b>Electrical</b>		
Standard	<b>UL</b>	<b>IEC</b>
Rated voltage	300V	250V
Rated current	8A	8A
Wire range	28-16AWG	1.0mm <sup>2</sup>
Withstanding voltage	AC2000V/1Min	
<b>Mechanical</b>		
Torque	0.2Nm(1.7Lb-In)	
Ambient temperature	-30°C~+120 °C	
Strip length	5-6mm	
<b>Dimensions</b>		
Pitch	3.5mm(.138")	
Poles	2P,3P-24P	
<b>Material</b>		
Housing	PBT,UL94V-0	
Screws	M2,steel, Cr <sup>3+</sup> Zn;plated	
Contact	Phosphor bronze	
Cage	Brass,Ni plated	

### HOW TO ORDER :

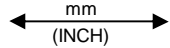

	 <b>DEGSON ELECTRONICS CO., LTD.</b>
	<b>NAME</b> <b>DG333K-3.5</b>