

## Standard Type Butt-connectors

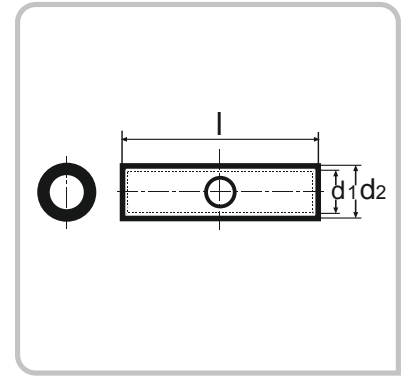

### Features

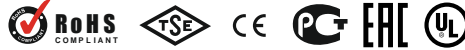



















- Tempering of the cable lugs during the production process provides easy and more practical usage of the Şafak Cable Lugs.
  - Cable lugs are reheated at 700 degrees so that they do not break after the crimping process.
  - All of the Şafak Cable Lugs are tempered during production process.
- ⚠ These butt-connectors must be crimped with ST series dies.

**Material** : EN 13600 standard copper  
**Surface Treatment** : Tin Plated

Product Code	Cross-Section mm <sup>2</sup>	Dimensions (mm)			Package Amount (Pcs)	Package Weight (-kg)
		d1	d2	L		
ST EM006	<b>6 mm<sup>2</sup></b>	3,8	5,5	30	800	2,30
ST EM010	<b>10 mm<sup>2</sup></b>	4,7	6,6	29	600	2,50
ST EM016	<b>16 mm<sup>2</sup></b>	5,6	7,8	32	400	2,50
ST EM025	<b>25 mm<sup>2</sup></b>	7,1	9,5	40,5	250	2,80
ST EM035	<b>35 mm<sup>2</sup></b>	8,2	10,8	45,5	150	2,30
ST EM050	<b>50 mm<sup>2</sup></b>	10,1	13	53,5	90	2,30
ST EM070	<b>70 mm<sup>2</sup></b>	11,5	14,7	57,5	65	2,20
ST EM095	<b>95 mm<sup>2</sup></b>	13,5	16,7	61,5	50	2,10
ST EM120	<b>120 mm<sup>2</sup></b>	15,6	19	74	40	2,40
ST EM150	<b>150 mm<sup>2</sup></b>	16,5	21	79	25	2,30
ST EM185	<b>185 mm<sup>2</sup></b>	18,4	23	85	22	2,50
ST EM240	<b>240 mm<sup>2</sup></b>	21	26	94	18	2,90
ST EM300	<b>300 mm<sup>2</sup></b>	23,4	28,6	98,5	10	2,00
ST EM400	<b>400 mm<sup>2</sup></b>	26,8	32,8	112	5	2,30
ST EM500	<b>500 mm<sup>2</sup></b>	29,8	38,4	120	5	2,36
ST EM600	<b>600 mm<sup>2</sup></b>	34,5	44	140	5	3,09

- Our goods are manufactured of electrolytic copper(E-Cu), they are full tempered, welded and min. 3 micron tin plated.
- Our company reserves the right of changing the dimension of the products without any prior notification

### RECOMMENDED HAND TOOLS

"Crimping Range mm <sup>2</sup> "	Tool Code	"Mechanical Crimping Tools"	"Mechanical Crimping Tools with Revolving Dies"	"Hydraulic Crimping Tools"	"Hydraulic Crimping Heads"	"Battery Operated Hy- draulic Crimping Tools"	"Crimping Profile"	Page
6-50	SP-0650		*					P67
6-240	SFK-60MINI ELEC					*		P77
6-300	SFK-60MINI S ELEC					*		P78
	SFK-60 ELEC					*		P79
	SFK-60S ELEC					*		P80
10-120	SP-120	*						P67
	SP-10120		*					P67
10-240	S-6			*				P71
10-300	SP-300	*						P67
	S-60			*				P71
16-300	SC-130			*				P71
	SXC-130				*			P72
	SFK-120 ELEC					*		P81
16-400	SC-130L			*				P71
	SXC-130L				*			P72
	SFK-120L ELEC					*		P82
16-600	SHK-25				*			P72
	SHK-45				*			P73
25-150	SP-25150		*					P67
625	SHK-110				*			P73