

Разъем 3,5мм стерео, гнездо на плату SMD, PJ-027

арт. Q-10641

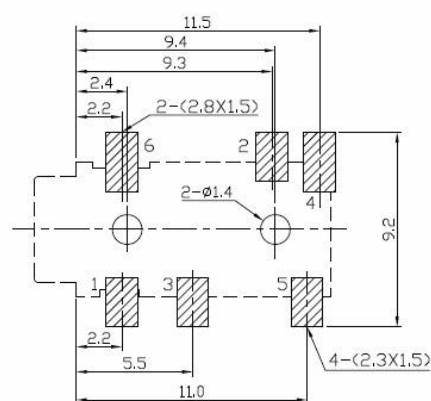

T:1.6 Dimensions of PC board holes
Tolerance : ±0.1(Printed-top view)

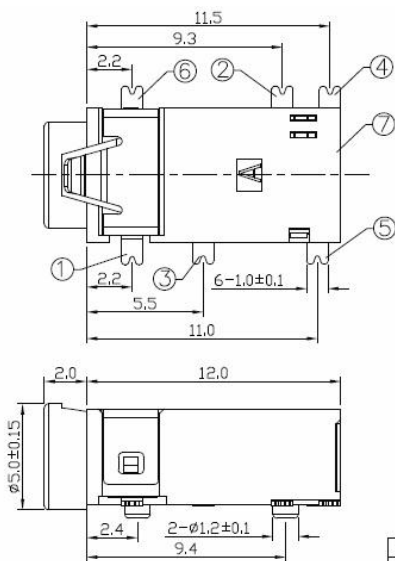
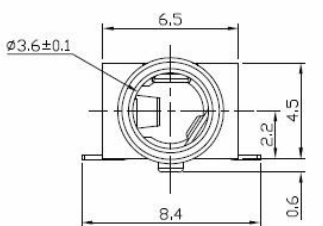
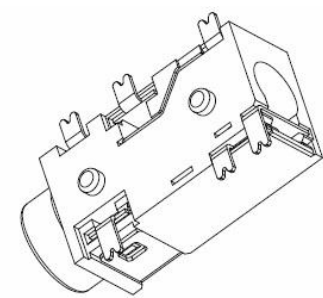
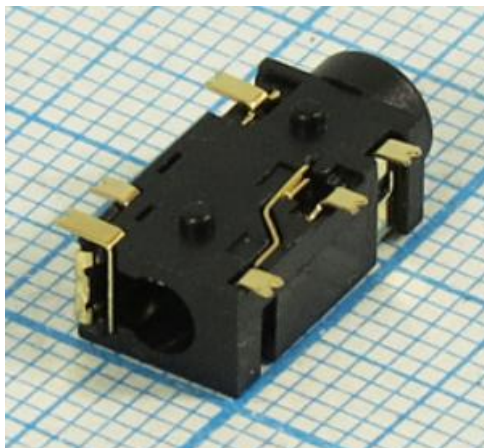
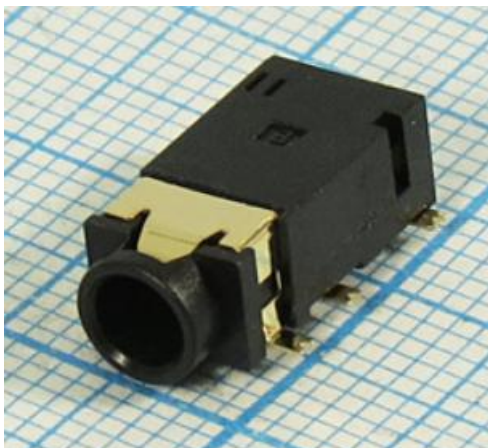
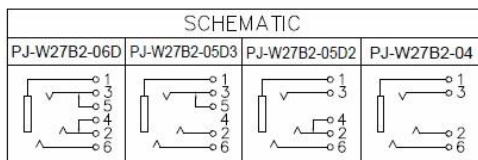

UNLESS OTHERWISE SPECIFIED, TOLERANCE ON DECIMAL: ±0.2

7	HOUSING	1	PA9T		UL-94V0(BLACK)
6	CONTACT FOOT	1	C2680	t=0.20	MB-Ni Au PLATED
5	CURVE PIECE	1	C5191	t=0.20	MB-Ni Au PLATED
4	CURVE PIECE	1	C5191	t=0.20	MB-Ni Au PLATED
3	SPRING FOOT	1	C5191	t=0.20	MB-Ni Au PLATED
2	SPRING FOOT	1	C5191	t=0.20	MB-Ni Au PLATED
1	CONTACT FOOT	1	C5191	t=0.20	MB-Ni Au PLATED
LTR	PART NAME	QTY	MATERIAL		REMARK