

Разъемы питания шаг 3,96мм, одnorядные.

PHU2 - гнездо

PWL2 - штекер

Female Terminal

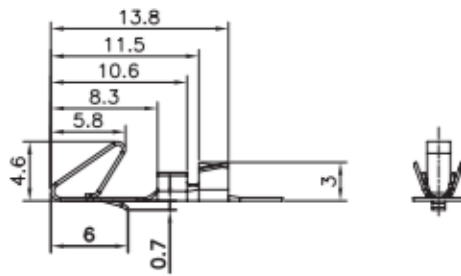

Female Terminal

Wire Range		O.D of Wire
Section Area (mm ²)	AWG#	mm
0.2~0.75	24~18	1.3~2.8

PHU
Female Housing

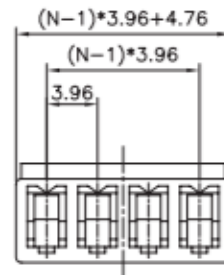
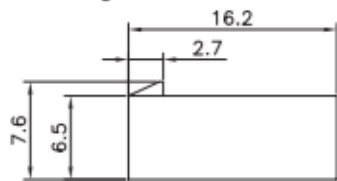

PWL-R
Male Right Angle

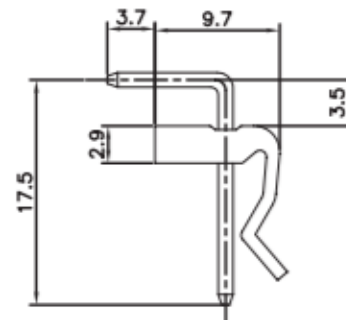
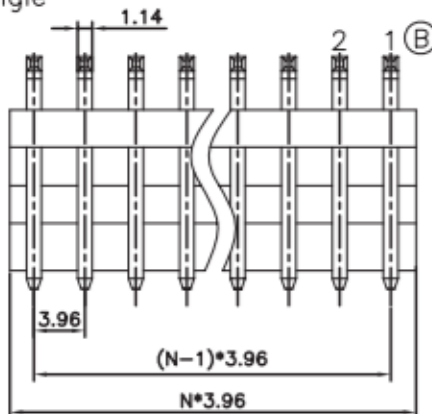

PWL
Male V/T TYPE

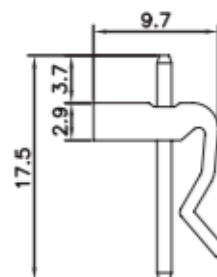
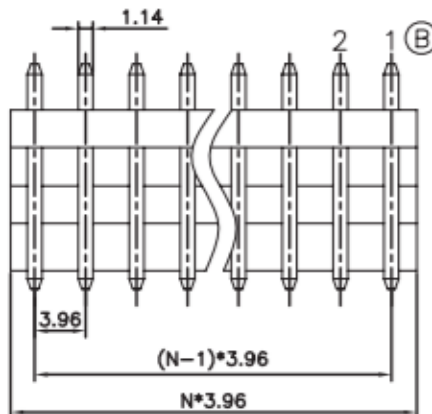

N=No. of contacts

NOTES:

1. MAIN SPECIFICATIONS

- . Housing material: NYLON 66
- . Wire range: AWG#24~#18
- . Rated voltage: 250V
- . Rated current: 1A
- . Contact resistance: $\leq 30m\Omega$
- . Insulation resistance: $\geq 1000M\Omega$
- . Withstanding voltage: 500V,AC 1 minute
- . Temperature range: $-25 \sim +85^{\circ}C$
- . Recommend PC board thickness:1.6mm

2. PRODUCT NUMBER CODE:

PHU- Female Housing
└── No.of contact
 2 to 13

PWL- R Male Right Angle
└── No.of contact
 2 to 13

PWL- Male V/T TYPE
└── No.of contact
 2 to 13

Соответствие ответных частей разъемов:

Гнезда	HB	H1	H	HU	PHU	PHU2	MHU	MMF	MFC	MF
Штекеры	WB	W1	W	WF	PWL	PWL2	MPW	TH	MFT	MFA