









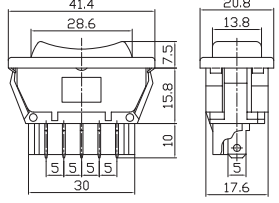

型号说明 Ordering Information

技术特性 Specification

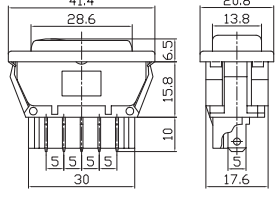
ASW-13D

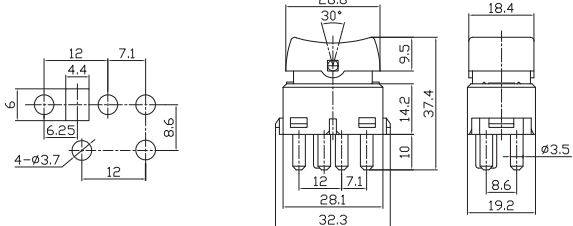
- 带直流感 With DC lamp
- 产品序号 Product order
- 汽车开关 Automotive switch

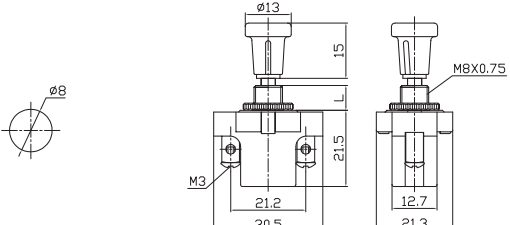
- 1.接触电阻 Contact Resistance:50mΩ max
- 2.绝缘电阻 Insulation Resistance:500VDC 100MΩ min
- 3.耐电压 Dielectric Strength:1500VAC, 1Minute
- 4.操作温度 Operating Temperature:-25℃ ~ +85℃
- 5.电气寿命 Electrical Life:10,000 Cycles

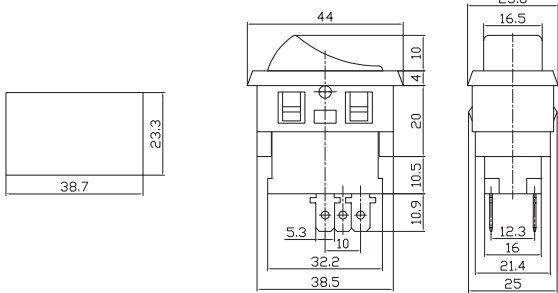
	<p>ASW-01 20A 12VDC;10A 30VDC DPDT 5P</p>	
	<p>ASW-02D 20A 12VDC DPDT 5P(with lamp)</p>	
	<p>ASW-03 ASW-03D DPDT 4P ASW-04 ASW-04D DPDT 5P 20A 12VDC</p>	
	<p>ASW-05(L=7,13,20) 10A 12VDC;6A 30VDC SPST 2P</p>	
	<p>ASW-06-101 ON-OFF 2P ASW-06-102 ON-ON 3P ASW-06-103 ON-OFF-ON 3P 10A 30VDC;20A 12VDC</p>	



ASW-07D ON-OFF
 25A 12VDC
 SPST 3P(with lamp)
 LED Color:Red,Yellow,
 Green,Blue,White,Purple

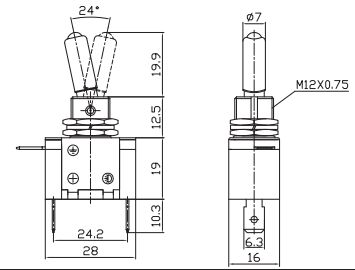
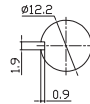

SAC-01
 (Switch Aircraft Cover)
 Color:Red,Yellow,Green,Blue,Purple,
 Black,Transparent,Chrome plating
 Used to ASW-07D, KN3(A),(B),(C),(D)

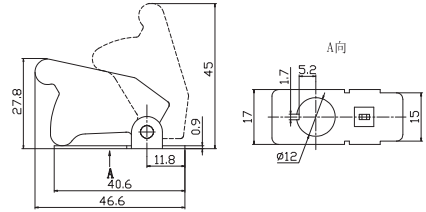

ASW-07D-2 ON-OFF
 30A 12VDC
 SPST 3P(with lamp)
 LED Color:Red,Yellow,
 Green,Blue,White,Purple

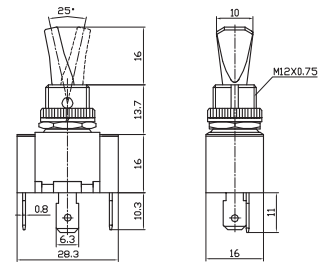
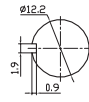

ASW-08 OFF-(ON)
 3A 30VDC;6A 12VDC
 SPST 2P

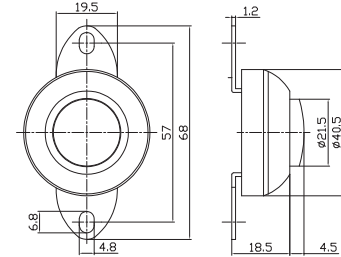
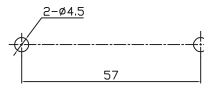

ASW-08H OFF-(ON)
 3A 30VDC;6A 12VDC
 SPST 2P

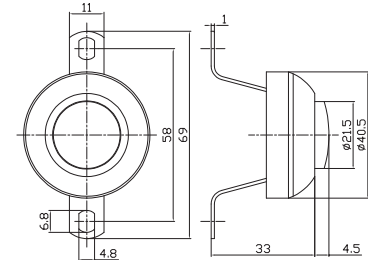
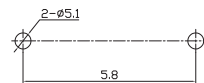

ASW-09D ON-OFF
 20A 12VDC(with lamp)
 SPST 3P

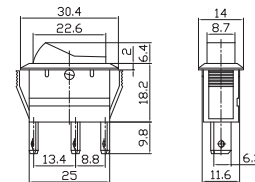
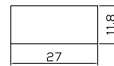

ASW-09-101 ON-OFF
 SPST 2P
ASW-09-102 ON-ON
 SPDT 3P
 20A 12VDC;10A 125VAC

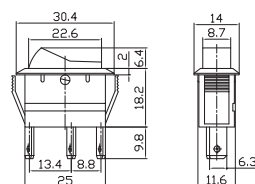
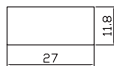



ASW-10-101 ON-OFF 2P
 ASW-10-102 ON-ON 3P
 ASW-10-103 ON-OFF-ON 3P
 35A 12VDC;20A 30VDC

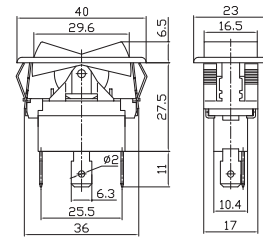
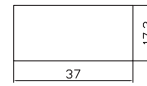

ASW-11D ON-OFF
 20A 12VDC(with lamp)
 SPST 3P

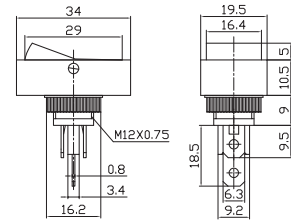

ASW-11-101 ON-OFF 2P
 ASW-11-102 ON-ON 3P
 20A 12VDC;10A 125VAC

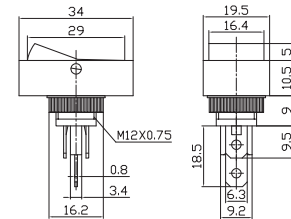

ASW-13D ON-OFF
 20A 12VDC(with lamp)
 SPST 3P

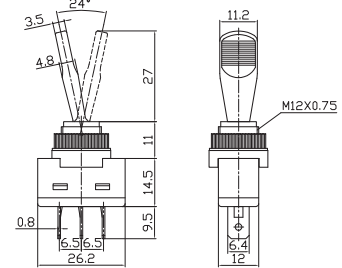

ASW-13-101 ON-OFF 2P
 ASW-13-111 (ON)-OFF 2P
 ASW-13-102 ON-ON 3P
 ASW-13-103 ON-OFF-ON 3P
 20A 12VDC;10A 125VAC

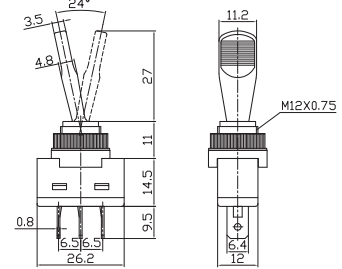

ASW-13-101L ON-OFF
 ASW-13-111L (ON)-OFF
 20A 12VDC;10A 125VAC
 SPST 2P

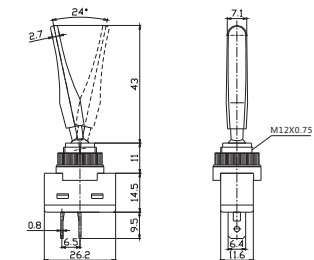

ASW-14D ON-OFF
 20A 12VDC(with lamp)
 SPST 3P

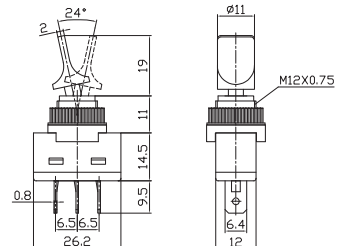



汽车开关

Automotive Switch

ASW Series



ASW-14-101 ON-OFF 2P
 ASW-14-102 ON-ON 3P
 ASW-14-103 ON-OFF-ON 3P
 20A 12VDC;10A 125VAC

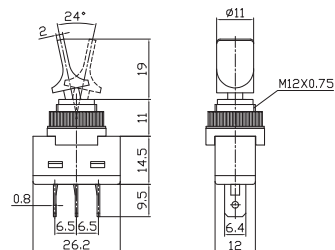

ASW-15D ON-OFF L=18
 ASW-15D-2 ON-OFF L=24
 20A 12VDC(with lamp)
 SPST 3P

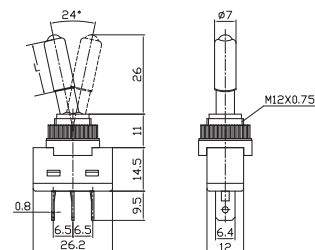

ASW-16-101 ON-OFF
 20A 12VDC;10A 125VAC
 SPST 2P

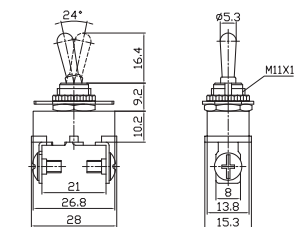

ASW-17D ON-OFF
 35A 12VDC(with lamp)
 DPST 4P

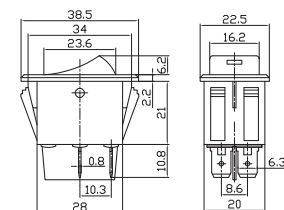
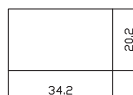

ASW-17-201 ON-OFF
 DPST 4P
 ASW-17-202 ON-ON
 DPDT 6P
 35A 12VDC

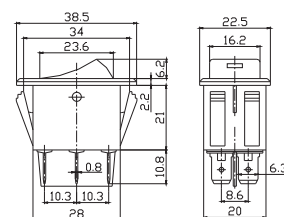
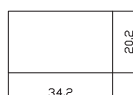

ASW-17-201N ON-OFF
 DPST 4P
 ASW-17-202N ON-ON
 DPDT 6P
 20A 125VDC; 15A 250VAC

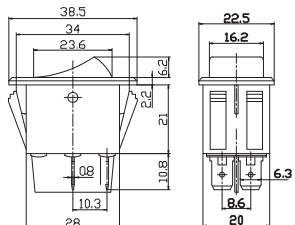
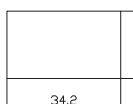

ASW-18 ON-(OFF)
 20A 12VDC

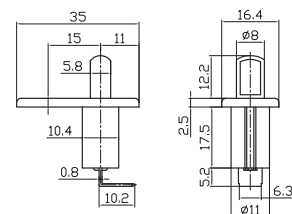
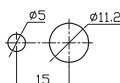



汽车开关

Automotive Switch

ASW Series



ASW-18-2 ON-(OFF)
20A 12VDC

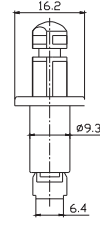
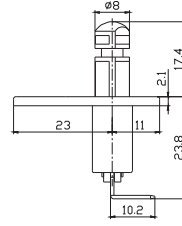
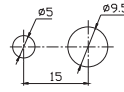

ASW-18-3 ON-(OFF)
20A 12VDC

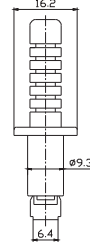
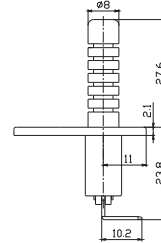
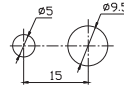

ASW-18-4 ON-(OFF)
20A 12VDC

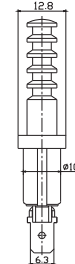
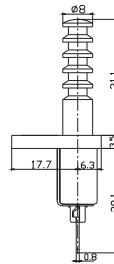
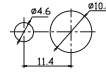

ASW-19 ON-(OFF)
20A 12VDC

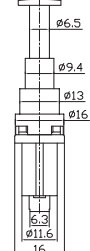
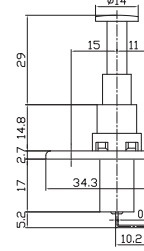
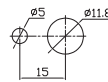

ASW-20D ON-OFF
20A 12VDC(with lamp)
ASW-20D-A ON-OFF
30A 12VDC(with lamp)
SPST 3P

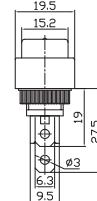
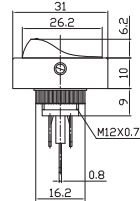

ASW-20D-2 ON-OFF
20A 12VDC(with lamp)
ASW-20D-2A ON-OFF
30A 12VDC(with lamp)
SPST 3P

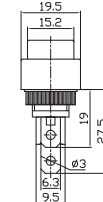
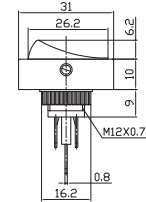

ASW-20D-3 ON-OFF
20A 12VDC(with lamp)
ASW-20D-3A ON-OFF
30A 12VDC(with lamp)
SPST 3P

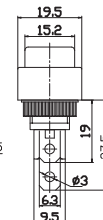
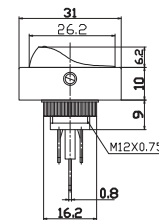



汽车开关

Automotive Switch

ASW Series

	<p>ASW-21D 20A 12VDC(with lamp) DPDT 6P</p>	
	<p>ASW-22 ON-OFF 20A 12VDC SPST 2P</p>	
	<p>ASW-23-101 ON-OFF 6A 120VAC;3A 240VAC ASW-23-101A ON-OFF 15A 120VAC;10A 240VAC SPST 2P</p>	
	<p>ASW-23-102A ON-ON ASW-23-103A ON-OFF-ON 15A 120VAC;10A 240VAC SPDT 3P</p>	
	<p>ASW-24 (ON)-OFF 20A 12VDC;10A 125VAC</p>	
	<p>ASW-25D ON-OFF 20A 12VDC;10A 125VAC SPST 3P</p>	
	<p>ASW-25-101 ON-OFF SPST 2P ASW-25-102 ON-ON SPDT 3P 20A 12VDC;10A 125VAC</p>	



ASW-26-101 ON-OFF
SPST 2P
ASW-26-102 ON-ON
SPDT 3P
20A 12VDC;10A 125VAC

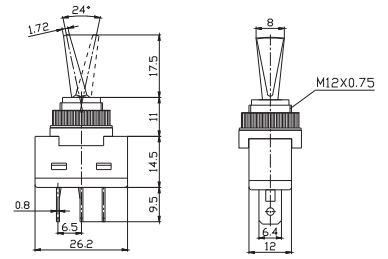

ASW-27 (ON)-ON-(ON)
40A 12VDC
DP3T 5P

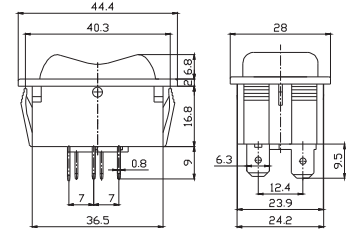
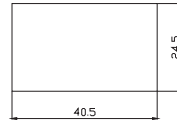

ASW-28 (原PBS-25B)
3A 125VAC;1A 250VAC

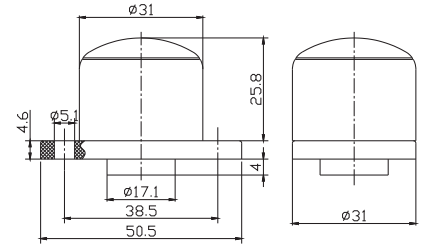

ASW-29D ON-OFF
Illuminated ON/OFF Button Switch
20A 12VDC
ASW-29 ON-OFF
ON/OFF Button Switch
10A 125VDC;6A 250VAC; 20A 12VDC

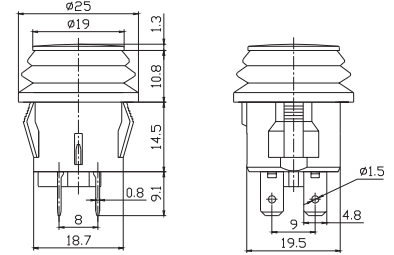
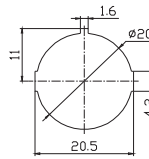

ASW-29E-D ON-OFF
Illuminated ON/OFF Button Switch
20A 12VDC

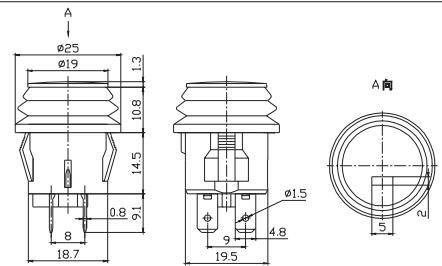
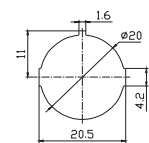

ASW-30D
Illuminated ON/OFF Rocker Switch
20A 12VDC;10A 24VDC
SPST 3P

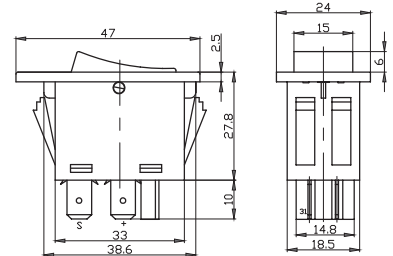
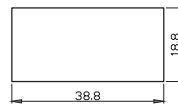

MIRS-101E-8C/D ON-OFF
16A 12VDC(with lamp)
SPST 3P

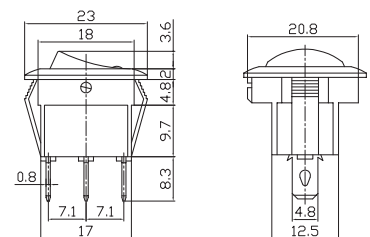
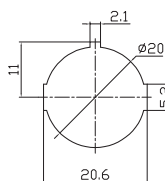



汽车开关

Automotive Switch

ASW Series

	<p>MIRS-101-8C/D ON-OFF 16A 12VDC(with lamp) SPST 3P</p>			
	<p>MRS-101-8C ON-OFF 2P MRS-102-8C ON-ON 3P MRS-103-8C ON-OFF-ON 3P 16A 12VDC; 10A 125VAC</p>			
	<p>MIRS-101-3D-2 ON-OFF 15A 12VDC(with lamp) SPST 3P</p>			
	<p>MIRS-101-2C/D ON-OFF 15A 12VDC(with lamp) SPST 3P</p>			
	<p>IRS-101E-12D ON-OFF 25A 12VDC SPST 3P</p>			
	<p>IRS-101-12D ON-OFF SPST 3P RS-101-12 ON-OFF SPST 2P 25A 12VDC</p>			
	<p>IRS-101-13D ON-OFF SPST 3P RS-101-13 ON-OFF SPST 2P 25A 12VDC</p>			



汽车开关 指示灯

Automotive Switch Warning Light

ASW Series WL Series



RS-123-11C (ON)-OFF-(ON)
35A 12VDC; 20A 125VAC
SPDT 3P

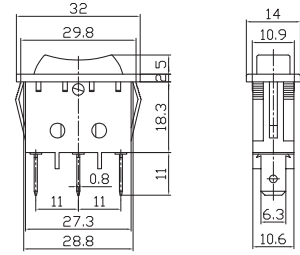
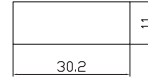

RS-223-4C (ON)-OFF-(ON)
35A 12VDC; 20A 125VAC
DPDT 6P

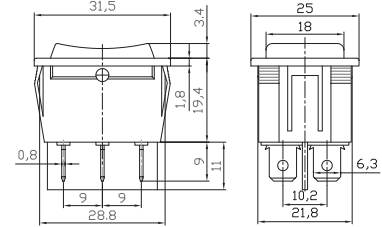
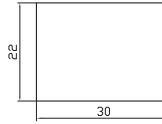

LS-01
Lamp Socket $\Phi 9.2$

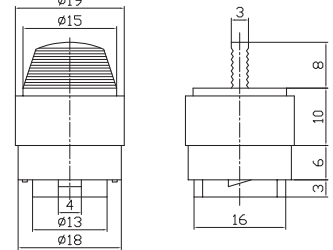

WL-01
12VDC;220VAC/110VAC

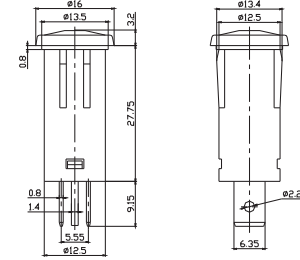

WL-01S
12VDC;220VAC/110VAC
(With wire)

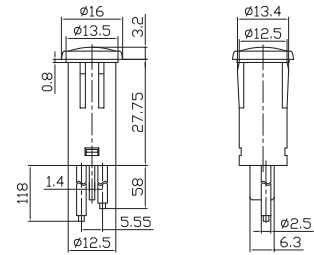

WL-02
12VDC;220VAC/110VAC

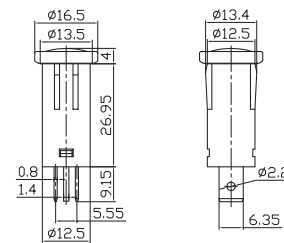

WL-02S
12VDC;220VAC/110VAC
(With wire)

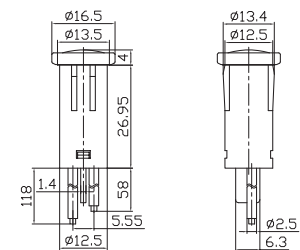



指示灯

Warning Light

WL Series



WL-03
50mA 12VDC

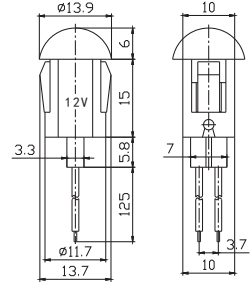
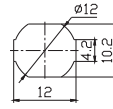

WL-04(LED)
12VDC

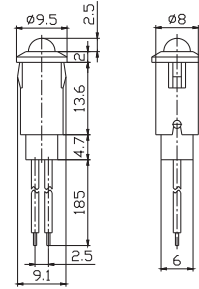
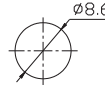

WL-05
50mA 12VDC

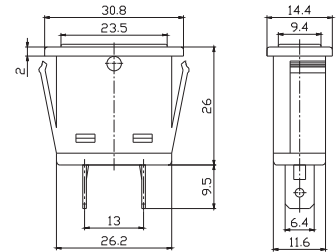
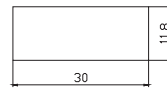

WL-06(LED)
12VDC

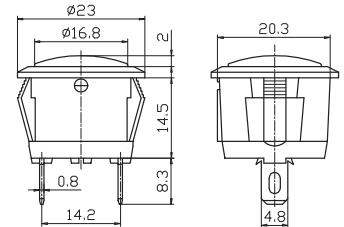
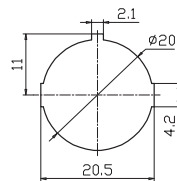

WL-07(LED)
12VDC

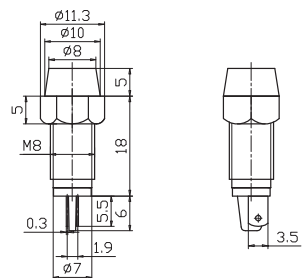

WL-08
12VDC

