

Push Switch

Q-9802

TYPE: **PB61301AL**



SPECIFICATIONS

Contact Type	SPST
Rating	DC 30V, 10mA
Contacts Resistance	50mΩ Max
Insulation Resistance	100MΩ Min
Minimum Load	DC 500V
Dielectric Strengths	AC 500V / 1 minute
Life Test	10 000 Cycles Min
Operating temperature range	-10°C to +80°C
Operating Force	150 ± 100gf

Outline Drawing

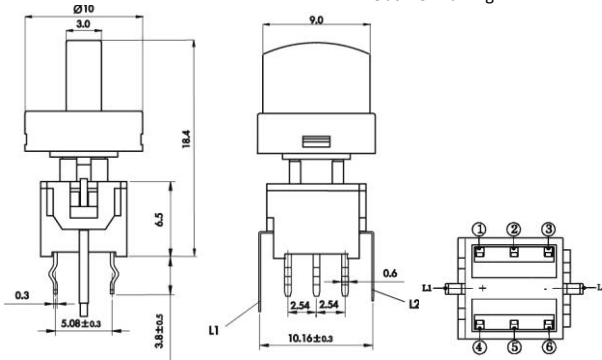

LED Color

1	Red
2	Yellow
3	Green
4	Blue
5	White
-	Non-illuminated

Mounting

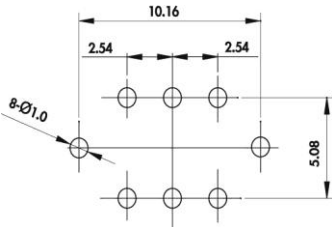

Circuitry

