

Speaker Specification

Customer's Model No.		Customer	QUARTZ-1		
Keпо Model No.	KPSP5785PF-8/0.25A	Size	Φ57mm	No.	J22312
No.	Item	Specification	Test Condition		
1	Impedance	$8\Omega \pm 15\%$	at 800Hz		
2	Resonant Fr. (f_0)	400Hz \pm 20%			
3	Frequency Range	F0-4.0KHz			
4	Rated Power	0.25W			
5	Max Power	0.3W			
6	S.P.L.	78 \pm 3dB	1W / 1M at 1.0k		
7	Distortion	Max 5%	at rated power 1.0kHz		
8	Sweep Test	must be normal	at sine wave 1.41 V		
9	Load Test	after test meet item 8	rated noise power, 24 Hrs.		
10	Heat Test	after test meet item 8	50 \pm 2 $^{\circ}$ C 5Hrs.		
11	Cold Test	after test meet item 8	-20 \pm 2 $^{\circ}$ C 5Hrs.		
12	Humidity Test	after test meet item 8	40 \pm 2 $^{\circ}$ C,90/95%R.H. 5Hrs.		
13	Weight				
14	Polarity Test	When supplied plus D.C. voltage to (+) terminal, the cone must move to forward.			
15	Note				

Dimensions:

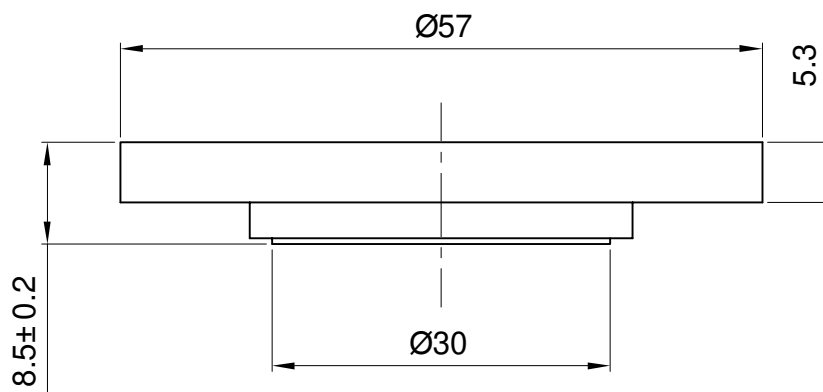
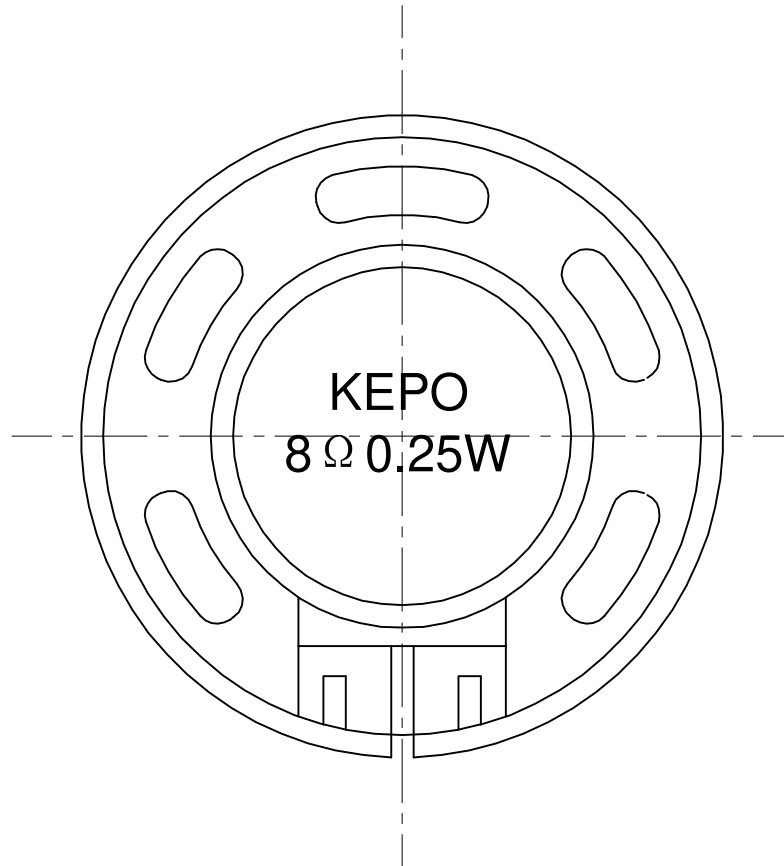

FIRST ANGLE PROJECTION

UNIT : mm
Tolerance : ±0.2