

# GP Batteries

## Data Sheet

Model No.: CR1220

Description : Flat Lithium Battery  
 Chemical system : Lithium Manganese Dioxide  
 Nominal voltage : 3 Volts  
 Nominal capacity : 36mAh  
 Dimensions :  $\phi 12.5 \times 2.0$ mm  
 Shelf life : 5 years at room temperature  
 Average weight : 0.8 grams  
 Applications : watch, calculator, camera and memory back up.

### Discharge Characteristics on load

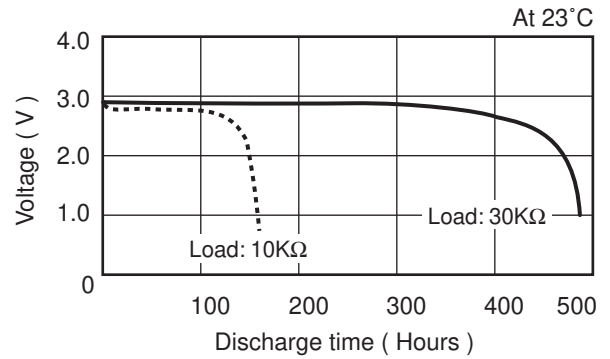

### Discharge characteristics on temperature

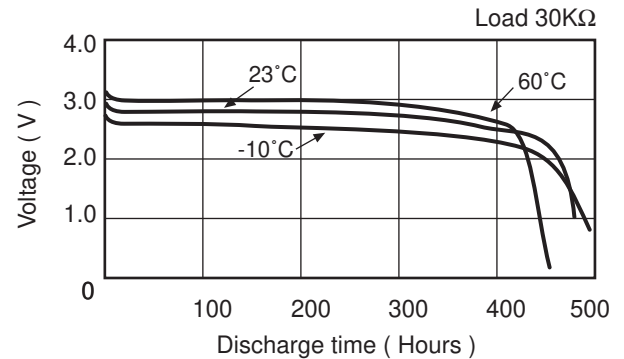

### Discharge characteristics on pulse load

(Discharge depth 40%)  
 Excellent low-impedance characteristics

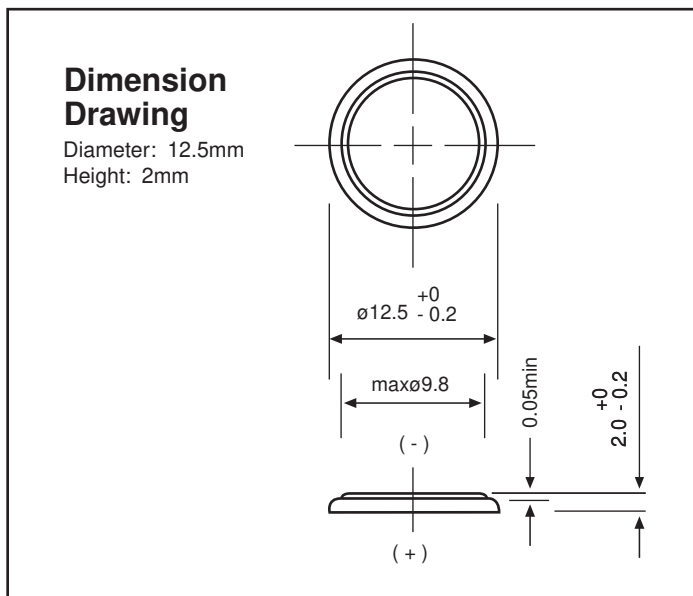
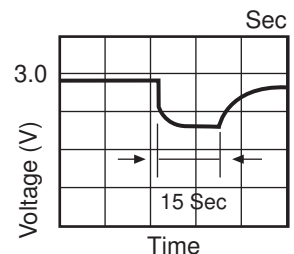
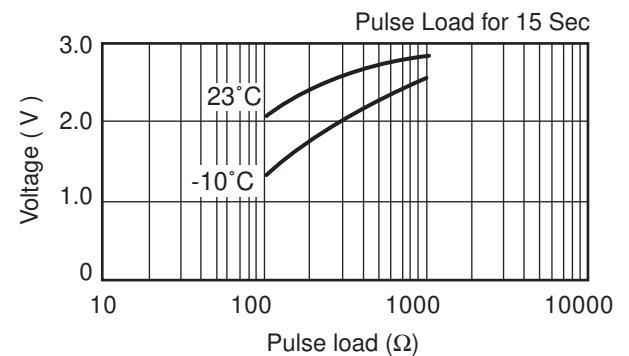

### Discharge load vs Discharge capacity

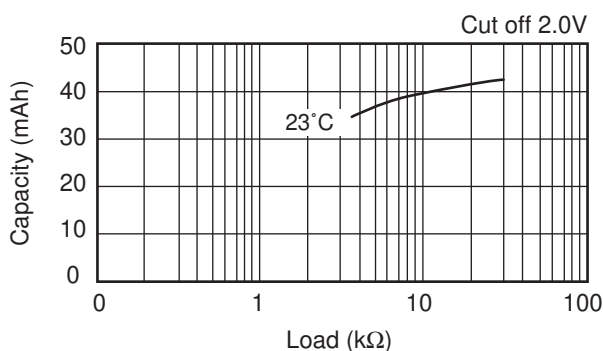

### Cross Reference:

IEC	JIS	Eveready	Varta
CR1220	CR1220	ECR1220	CR1220