

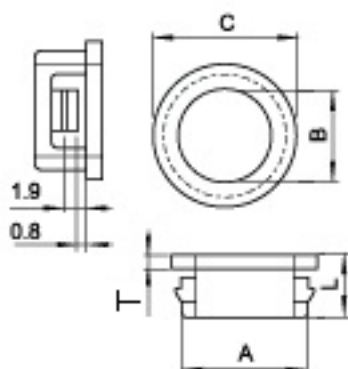













## Втулки проходные



- Материал: нейлон 66, 94V-2
- Цвет: черный
- Втулки защищают изоляцию проводов от острых краев металлических отверстий шасси.
- Надежная фиксация втулки в отверстии с помощью простого надавливания на втулку.
- Защита электрических проводов, кабеля, лент.
- Втулки для шасси толщина до 3.2 мм



	Наименование	Монтажное отверстие A	B	C	L	T
	SB-7S	7.1	5.8	8.8	6.1	1.3
	SB-8S	7.9	6.8	9.8	6.0	1.5
	SB-12S	11.9	9.2	13.7	6.3	1.5
	SB-22S	22.2	19.6	24.0	6.5	1.5
	SB-8A	7.9	5.1	10.5	8.0	1.6
	SB-8	7.9	5.8	10.5	8.0	1.6
	SBP-8	7.4	5.9	10.8	15.0	2.0
	SB-10	9.5	6.4	12.0	10.3	1.6
	SB-10M	9.5	7.8	13.0	10.5	1.6
	SB-13	12.7	8.0	15.0	10.3	1.6
	SB-14	14.3	11.4	17.0	10.3	1.5

	SB-16	15.9	12.7	18.6	10.3	1.6
	SB-19	19.1	14.3	21.7	10.3	1.6
	SB-19M	19.1	15.8	21.7	10.3	1.6
	SB-20	20.0	15.9	22.4	10.0	1.4
	SB-22	22.2	17.5	24.2	11.5	1.6
	SB-22M	22.2	18.9	24.2	11.5	1.6
	SB-25	25.4	19.5	28.5	11.7	1.8
	SB-26	25.8	19.1	28.5	11.5	1.6
	SB-30	30.1	24.1	33.3	11.5	1.6
	SB-32	32.0	23.8	34.6	11.4	1.5
	SB-38	38.1	29.0	42.1	11.4	1.5
	SB-45	44.5	35.4	47.8	11.6	1.5
	SB-50	50.8	41.6	54.6	11.8	1.6