

BLA-241

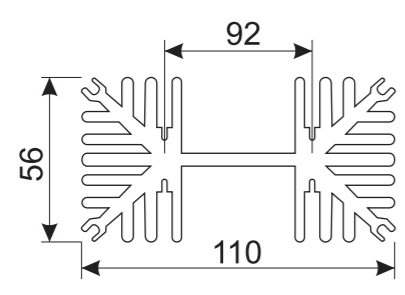

BLA-242

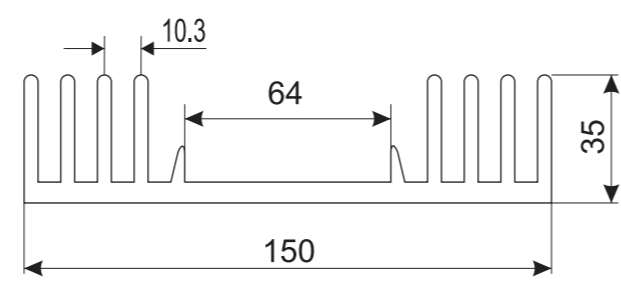

BLA-243

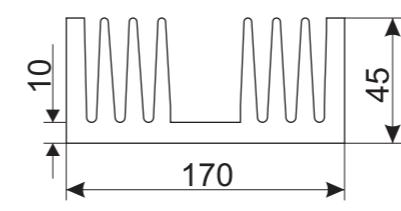

BLA-244

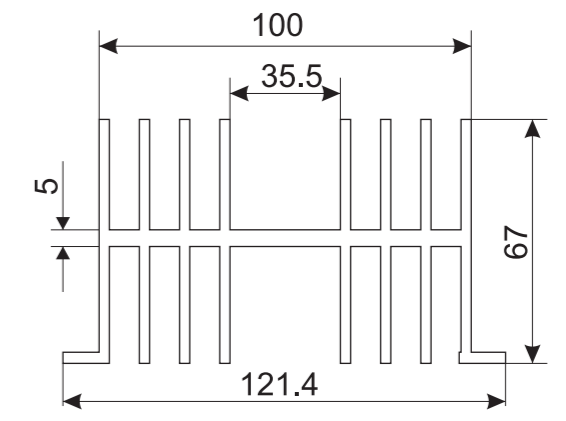

BLA-245

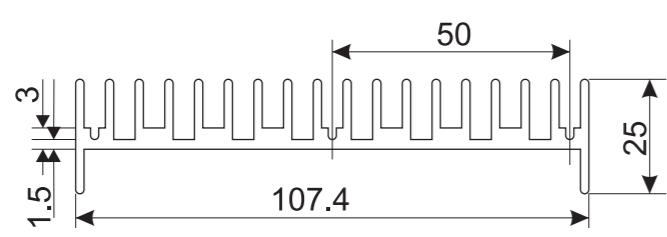

BLA-246

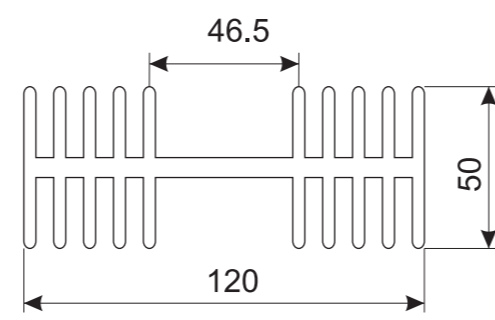

BLA-247

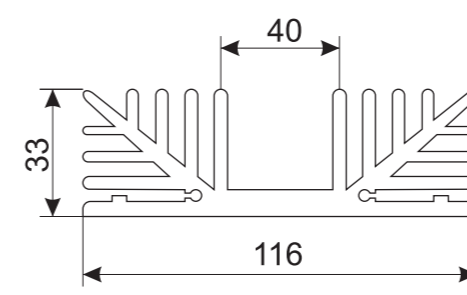

BLA-248

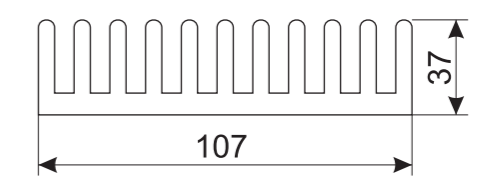

BLA-249

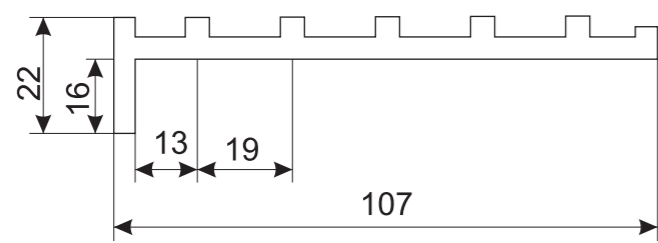

BLA-250

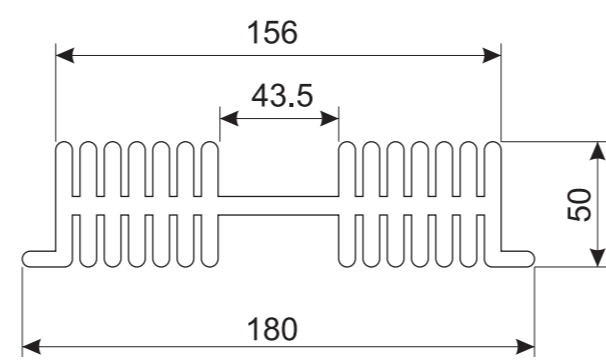

BLA-251

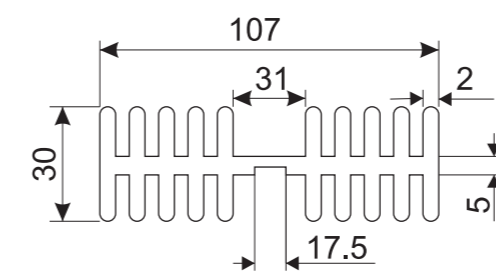

BLA-252

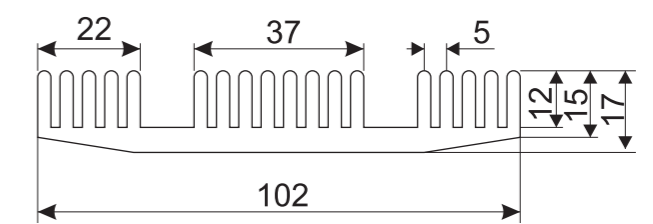

BLA-253

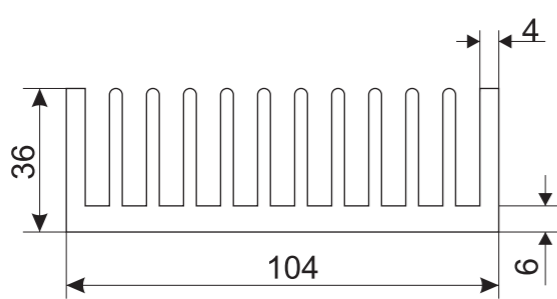

BLA-254

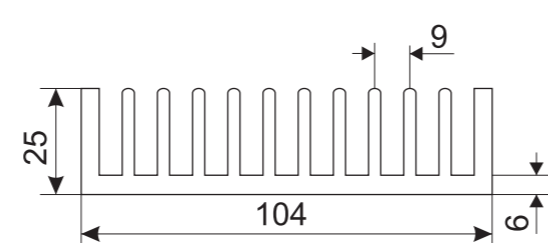

BLA-255

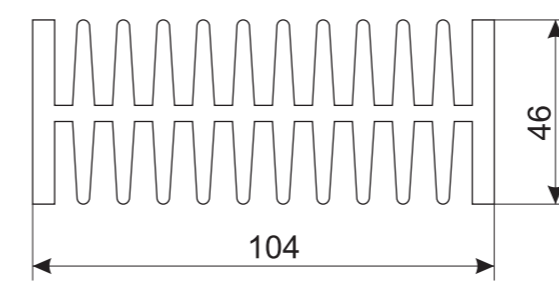

BLA-256

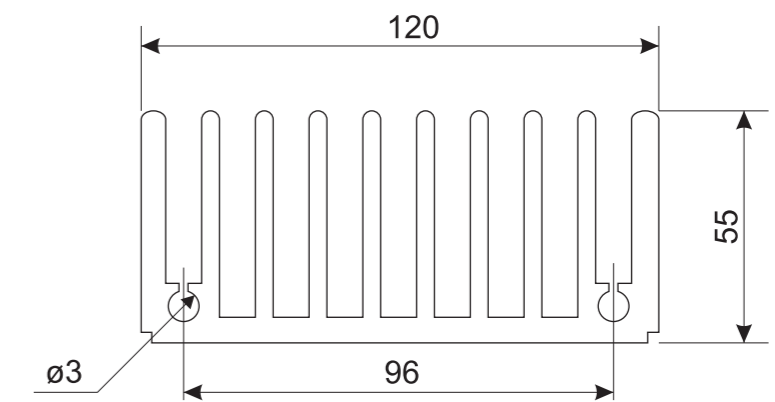

BLA-257

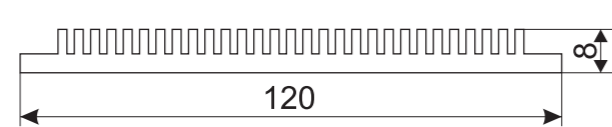

BLA-258

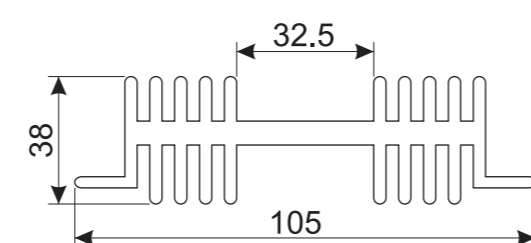

BLA-259

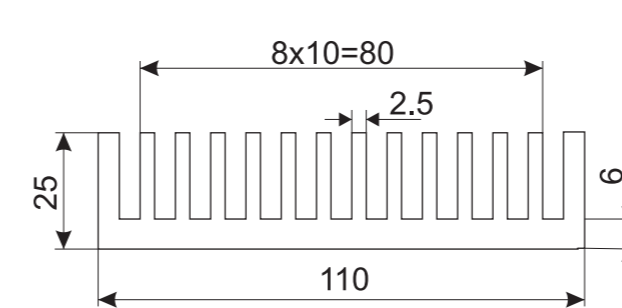

BLA-260

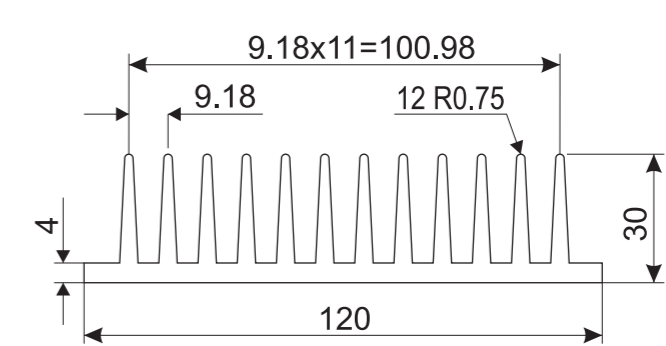

BLA-261

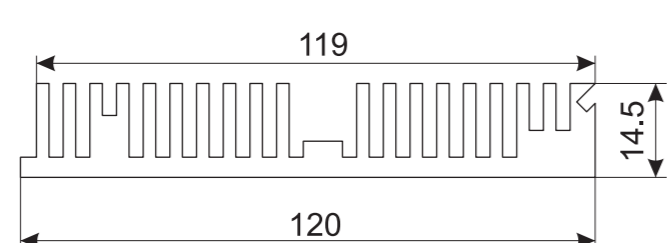

BLA-262

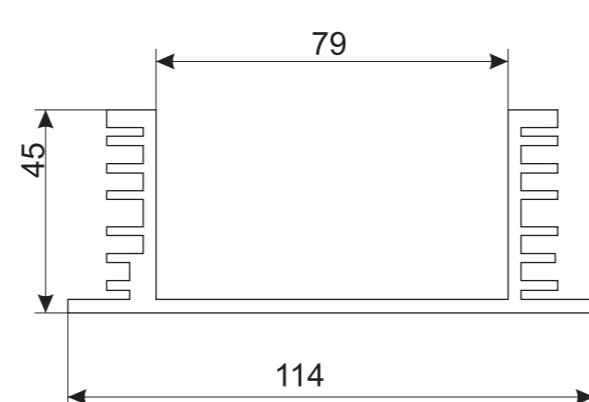

BLA-263

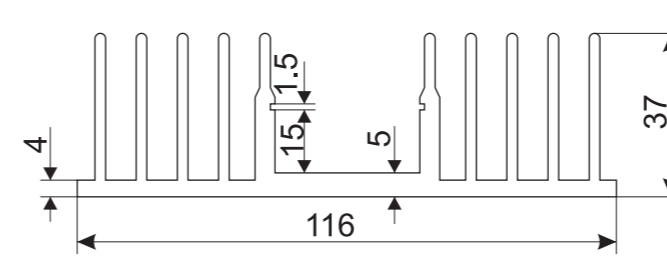

BLA-264

