



VISHAY INTERTECHNOLOGY, INC.

INTERACTIVE

data book

FREQUENCY CONTROL PRODUCTS

VISHAY DALE

VSE-DB0020-0507

Notes:

1. To navigate:
 - a) Click on the Vishay logo on any datasheet to go to the Contents page for that section. Click on the Vishay logo on any Contents page to go to the main Table of Contents page.
 - b) Click on the products within the Table of Contents to go directly to the datasheet.
 - c) Use the scroll or page up/page down functions.
 - d) Use the Adobe® Acrobat® page function in the browser bar.
2. To search the text of the catalog use the Adobe® Acrobat® search function.



VISHAY INTERTECHNOLOGY, INC.



DATA BOOK

FREQUENCY CONTROL PRODUCTS

Tuning Fork Crystals

Quartz Crystals

Thru-Hole Oscillators

Surface Mount Clock Oscillators

SEMICONDUCTORS

RECTIFIERS

Schottky (single, dual)
 Standard, Fast and Ultra-fast Recovery
 (single, dual)
 Clamper/Damper
 Bridge
 Superrectifier®
 Sinterglass Avalanche Diodes

SMALL-SIGNAL DIODES

Schottky and Switching (single, dual)
 Tuner/Capacitance (single, dual)
 Bandswitching
 PIN

ZENER AND SUPPRESSOR DIODES

Zener (single, dual)
 TVS (TRANSZORB®, Automotive, ESD,
 Arrays)

MOSFETs

Power MOSFETs
 JFETs

RF TRANSISTORS

Bipolar Transistors (AF and RF)
 Dual Gate MOSFETs
 MOSMICs®

OPTOELECTRONICS

IR Emitters, Detectors,
 and IR Receiver Modules
 Optocouplers and Solid-state Relays
 Optical Sensors
 LEDs and 7-Segment Displays
 Infrared Data Transceiver Modules
 Custom Products

ICs

Power ICs
 Analog Switches
 DC/DC Converters
 RF Transceivers

PASSIVE COMPONENTS

RESISTIVE PRODUCTS

Foil Resistors
 Film Resistors
 Thin Film Resistors
 Thick Film Resistors
 Metal Oxide Film Resistors
 Carbon Film Resistors
 Wirewound Resistors
 Power Metal Strip® Resistors
 Variable Resistors
 Cermet Variable Resistors
 Wirewound Variable Resistors
 Conductive Plastic Variable Resistors
 Networks/Arrays
 Non-linear Resistors
 NTC Thermistors
 PTC Thermistors
 Varistors

MAGNETICS

Inductors
 Transformers

CAPACITORS

Tantalum Capacitors
 Solid Tantalum Capacitors
 Wet Tantalum Capacitors
 Ceramic Capacitors
 Multilayer Chip Capacitors
 Disc Capacitors
 Film Capacitors
 Power Capacitors
 Heavy-Current Capacitors
 Aluminum Capacitors
 Silicon Capacitors

STRAIN GAGES AND INSTRUMENTS

PHOTOSTRESS® INSTRUMENTS

TRANSDUCERS

Load Cells
 Instruments
 Force Transducers
 Weighing Systems

Frequency Control Products

Vishay Dale
1505 E. Highway 50
P.O. Box 180
Yankton, SD 57078-0180, USA
Phone: 605-665-9301
Fax: 605-665-1627
www.vishay.com

Specifications of the products displayed herein are subject to change without notice. Vishay Intertechnology, Inc., or anyone on its behalf, assumes no responsibility or liability for any errors or inaccuracies.

Information contained herein is intended to provide a product description only. No license, express or implied, by estoppel or otherwise, to any intellectual property rights is granted by this document. Except as provided in Vishay's terms and conditions of sale for such products, Vishay assumes no liability whatsoever, and disclaims any express or implied warranty, relating to sale and/or use of Vishay products including liability or warranties relating to fitness for a particular purpose, merchantability, or infringement of any patent, copyright, or other intellectual property right.

The products shown herein are not designed for use in medical, life-saving, or life-sustaining applications. Customers using or selling these products for use in such applications do so at their own risk and agree to fully indemnify Vishay for any damages resulting from such improper use or sale.



FREQUENCY CONTROL PRODUCTS

Contents	1
Alphabetical Index	2
Crystal - Terms and Definitions	3
Crystal - Product Selector Guide	4
Crystal - Ordering Guide.....	5

TUNING FORK CRYSTALS

XT26T..... 32.768 KHz, Tuning Fork Watch Crystal, 2 x 6 mm.....	6
XT38T..... 32.768 KHz, Tuning Fork Watch Crystal, 3 x 8 mm.....	7
XT38P..... 32.768 KHz, Tuning Fork Watch Crystal, 2.5 mm Profile.....	8
XT32P..... 32.768 KHz, Tuning Fork Watch Crystal, 3.5 mm Low Profile.....	9

QUARTZ CRYSTALS

XT49U..... 1.8432 - 125.0 MHz, Industry Standard Microprocessor HC49U Crystal.....	10
XT49S..... 3.2 - 66.0 MHz, Standard Footprint, "AT" Strip, 3.5 mm Profile.....	11
XT49SL..... 3.2 - 66.0 MHz, Standard Footprint, "AT" Strip, 2.5 mm Low Profile.....	12
XT49M..... 3.2 - 66.0 MHz, Standard HC49/US SMD, 5.0 mm Profile.....	13
XT49ML..... 3.2 - 66.0 MHz, Standard HC49/US SMD, 4.0 mm Low Profile.....	14
XTUM1..... 10 - 125.0 MHz, Resistance Weld, for Space Limited Applications.....	15
XT36C..... 10 - 80.0 MHz, Microprocessor, 1.6 mm Profile.....	16
XT57C..... 9.8304 - 100.0 MHz, 5 x 7 x 1.3 mm, Seam Sealed, Tight Tolerance.....	17
XT46C..... 10 - 80.0 MHz, 3.5 x 6x 1.1 mm, Economical Cost.....	18
Oscillator - Terms and Definitions	19
Oscillator - Product Selector Guide	20
Oscillator - Ordering Guide.....	22

THRU-HOLE OSCILLATORS

XO-53..... 1.0 - 100.0 MHz, Economical, 14 Pin Dip, TTL Compatible.....	23
XO-54..... 1.0 - 100.0 MHz, 14 Pin Dip, HCMOS/TTL, Tri-State Enable/Disable Option.....	24
XO-543..... 1.0 - 100.0 MHz, 3.3 V, HCMOS/TTL, 14 Pin, Tri-State Enable/Disable Option.....	25
XO-52..... 1.0 - 100.0 MHz, 8 Pin Dip, HCMOS/TTL, Tri-State Enable/Disable Option.....	26
XO-523..... 1.0 - 100.0 MHz, 3.3 V, HCMOS/TTL, 8 Pin, Tri-State Enable/Disable Option.....	27
XO-56..... 1.0 - 999.9 KHz, HCMOS/TTL, 14 Pin Dip, Low Frequency.....	28
XOVC-23..... 1.0 - 40.0 MHz, 14 Pin Dip, HCMOS/TTL.....	29

SURFACE MOUNT CLOCK OSCILLATORS

XOSM-52..... 1.0 - 100.0 MHz, Gull Wing, HCMOS/TTL, Tri-State Enable/Disable Option.....	30
XOSM-55..... 1.0 - 100.0 MHz, Thermoplastic J-leaded, 5 V, Tri-State Enable/Disable Option.....	31
XOSM-553..... 1.0 - 100.0 MHz, Thermoplastic J-leaded, 3.3 V, Tri-State Enable/Disable Option.....	32
XOSM-57..... 1.0 - 100.0 MHz, 5 x 7 x 1.6 mm, 5 V, HCMOS/TTL, Tri-State Enable/Disable Option.....	33
XOSM-573..... 1.0 - 100.0 MHz, 5 x 7 x 1.6 mm, 3.3 V, HCMOS/TTL, Tri-State Enable/Disable Option.....	34
XOSM-572..... 1.0 - 100.0 MHz, 2.5 V, HCMOS/TTL, Tri-State Enable/Disable Option.....	35
XOSM-571..... 1.0 - 100.0 MHz, 1.8 V, HCMOS/TTL, Tri-State Enable/Disable Option.....	36
XOSM-533..... 1.0 - 100.0 MHz, 3.3 V, HCMOS/TTL, Tri-State Enable/Disable Option.....	37
XOSM-532..... 1.0 - 100.0 MHz, 2.5 V, HCMOS/TTL, Tri-State Enable/Disable Option.....	38
XOSM-531..... 1.0 - 100.0 MHz, 1.8 V, HCMOS/TTL, Tri-State Enable/Disable Option.....	39

PACKAGING SPECIFICATIONS

Tube Specifications.....	40
Tape and Reel Specifications.....	41
Packaging Specifications, Radial Lead.....	42
Packaging.....	44
Environmental and Mechanical.....	45
Test Circuits.....	45
Soldering Profile.....	46
Cross Reference.....	47

Cross Reference.....	47
Crystal - Ordering Guide.....	5
Crystal - Product Selector Guide.....	4
Crystal - Terms and Definitions.....	3
Environmental and Mechanical Specifications.....	45
Oscillator - Ordering Guide.....	22
Oscillator - Product Selector Guide.....	20
Oscillator - Terms and Definitions.....	19
Packaging Specifications, Radial Lead.....	42
Soldering Profile.....	46
Tape and Reel Specifications.....	41
Test Circuits.....	45
Tube Specifications.....	40
XO-52.....	26
XO-523.....	27
XO-53.....	23
XO-54.....	24
XO-543.....	25
XO-56.....	28
XOSM-52.....	30
XOSM-531.....	39
XOSM-532.....	38
XOSM-533.....	37
XOSM-553.....	32
XOSM-57.....	33
XOSM-571.....	36
XOSM-572.....	35
XOSM-573.....	34
XOVC-23.....	29
XT26T.....	6
XT32P.....	9
XT36C.....	16
XT38P.....	8
XT38T.....	7
XT46C.....	18
XT49M.....	13
XT49ML.....	14
XT49S.....	11
XT49SL.....	12
XT49U.....	10
XT57C.....	17
XTUM1.....	15



Crystals

QUARTZ

Quartz is formed from silicon and oxygen. It grows naturally or can be cultured in autoclaves under high pressure and heat. Most quartz used today by crystal manufacturers is cultured so that its purity and quality can be controlled. Quartz is used in Frequency Control Products because of its piezoelectric properties.

PIEZOELECTRIC EFFECT

When pressure is applied on a quartz crystal, a voltage is generated. The voltage produces a mechanical motion and vibration. The frequency of these vibrations is measured in hertz.

OPERATING MODES

A crystal can operate in a circuit in one of two modes, series or parallel.

- **SERIES RESONANCE:**

When a crystal is operated at series resonance it appears resistive and no load capacitor is required.

- **PARALLEL MODE:**

Crystals operated in this mode appear inductive in the circuit. A load capacitor must be specified for the crystal to operate at the proper frequency. Typical values of load capacitors at 18 pF, 20 pF, 30 pF or 32 pF.

FREQUENCY STABILITY

This is the allowable deviation from nominal frequency over a specified temperature range. It is expressed in ppm or % of nominal frequency.

FREQUENCY TOLERANCE

This is the maximum allowable deviation from the nominal frequency at 25 °C.

FUNDAMENTAL AND OVERTONE CRYSTALS

A crystal vibrates at many frequencies. The lowest frequency is called the fundamental mode and is usually supplied up to 30 MHz. Higher frequencies are achieved by operating the crystal at odd overtones (3rd, 5th, 7th and 9th) and tuning the circuit so the crystal operates at the designed overtone frequency.













PULLABILITY

The change in frequency (measured in ppm) for a given change in the parallel load capacitance is the pullability of the crystal. This will be specified for special applications such as VCXOs.

EQUIVALENT SERIES RESISTANCE

This is the resistance of the crystal measured at the series resonance frequency. The resistance measured at the parallel load resonant frequency is called the effective resistance.

Crystals

SELECTOR GUIDE - CRYSTALS					
PRODUCT	FREQUENCY RANGE	FREQUENCY TOLERANCE (TYPICAL)	TEMPERATURE STABILITY (TYPICAL)	TEMPERATURE RANGE	KEY FEATURES
XT26T 	32.768 KHz	20 ppm		-10 to + 60 °C	Tuning fork Low cost Sub-miniature package
XT38T 	32.768 KHz	20 ppm		-10 to + 60 °C	Tuning fork Low cost Sub-miniature package
XT38P 	32.768 KHz	20 ppm		-40 to + 85 °C	Tuning fork Low cost Surface mount package
XT32P 	32.768 KHz	20 ppm		-40 to + 85 °C	Tuning fork Low cost Surface mount package
XT49U 	1.8432 to 125 MHz	30 ppm	30 ppm	-20 to + 70 °C	Industry standard Low cost Hermetically sealed
XT49S 	3.2 to 66 MHz	30 ppm	30 ppm	-20 to + 70 °C	Industry standard 3.5 mm profile Low cost Hermetically sealed
XT49SL 	3.2 to 66 MHz	30 ppm	30 ppm	-20 to + 70 °C	Industry standard 2.5 mm profile Low cost Hermetically sealed
XT49M 	3.2 to 66 MHz	30 ppm	30 ppm	-20 to + 70 °C	Industry standard 4.5 mm profile Low cost Hermetically sealed
XT49ML 	3.2 to 66 MHz	30 ppm	30 ppm	-20 to + 70 °C	Industry standard 3.5 mm profile Low cost Hermetically sealed
XTUM 	10 to 125 MHz	10 ppm	10 ppm	-40 to + 85 °C	Miniature package Wide frequency range
XT36C 	10 to 80 MHz	50 ppm	50 ppm	-10 to + 70 °C	Surface mountable 1.6 mm profile
XT57C 	9.8304 to 100 MHz	30 ppm	30 ppm	-10 to + 60 °C	Miniature package Low cost
XT46C 	10 to 80 MHz	30 ppm	30 ppm	-10 to + 60 °C	Miniature package Low cost



Global Part Numbering Crystals

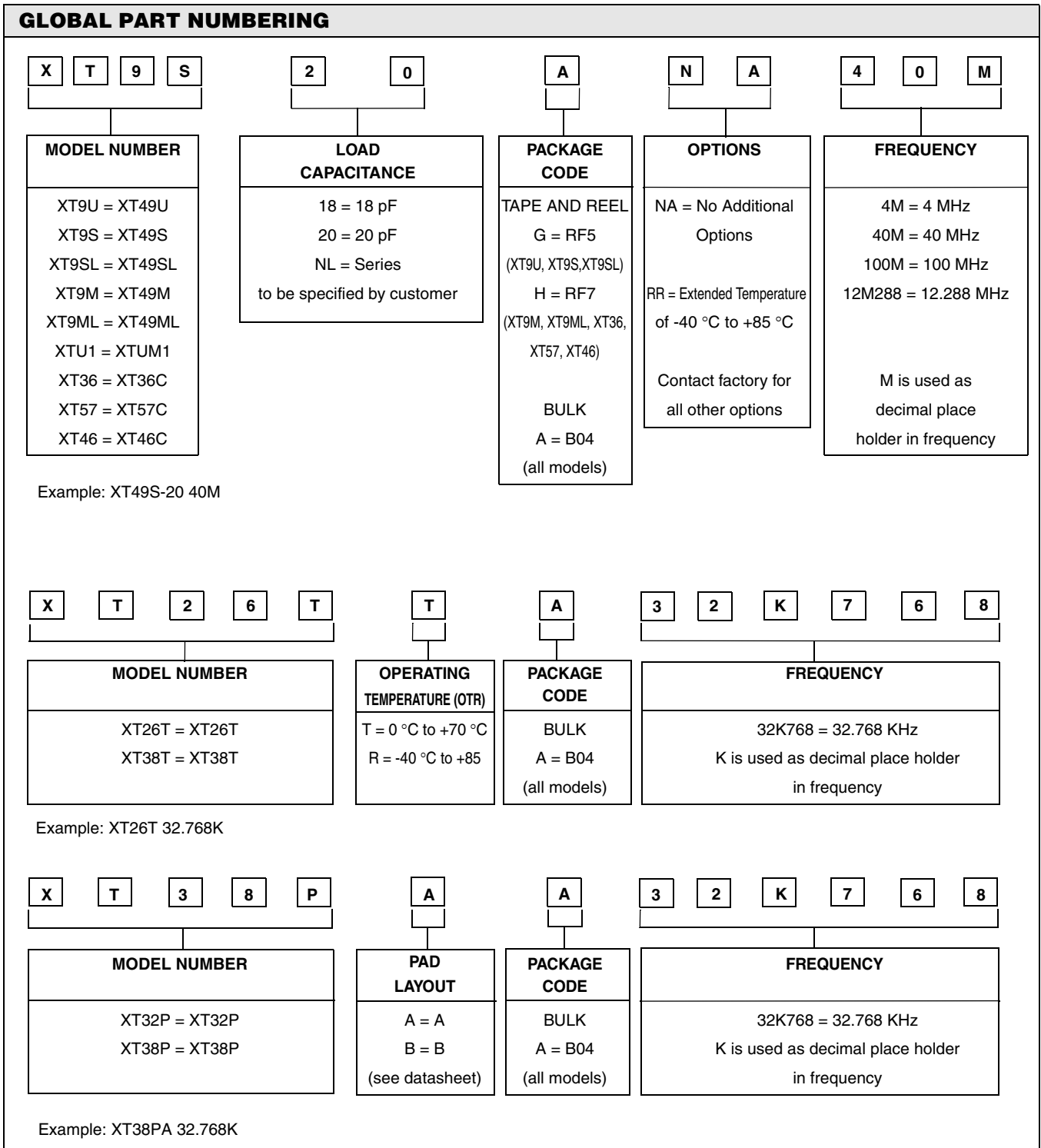

Tuning Fork Crystal



The tuning fork type quartz crystal provides ultimate in size, performance and economic trade-offs. So it is used as a clock source in communication equipment, measuring instrument, microprocessor and other time management applications.

FEATURES

- Miniature package
- Low cost
- KHz frequency
- Tight tolerance
- 100 % Lead (Pb)-free and RoHS compliant



RoHS
COMPLIANT

STANDARD ELECTRICAL SPECIFICATIONS						
PARAMETER	SYMBOL	CONDITION	UNIT	MIN	TYPICAL	MAX
Frequency Range	F _O		KHz		32.768	
Frequency Tolerance	ΔF/F _O	at 25 °C	ppm		±20	
Frequency Coefficient	K	ref to 25 °C	ppm/(Δ°C) ²			-0.042
Operating Temperature Range	T _{OPR}		°C	-10		+60
Storing Temperature Range	T _{STG}		°C	-20		+70
Shunt Capacitance	C _O		pF		0.85	2
Motional Capacitance	C ₁		fF	1	2	4
Load Capacitance	CL		pF		12.5	
Insulation Resistance	IR	100 V _{DC}	MΩ	500		
Drive Level	DL		μW			1
Aging (first year)	Fa	at 25 °C ± 3° C	ppm	-5.0		+5.0
Equivalent Series Resistance(ESR)	Rs		KΩ			50

DIMENSIONS in inches [millimeters]

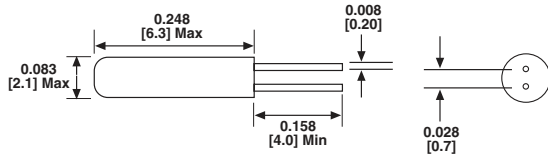

PARABOLIC TEMPERATURE CURVE

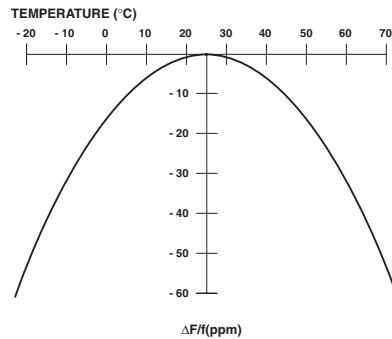

ORDERING INFORMATION		
XT26T	32.768 KHz	e2
MODEL	FREQUENCY/KHz	JEDEC LEAD
		FREE STANDARD

To determine frequency stability, use parabolic curvature (k).
For example: What is stability at 45 °C?

- 1) Change in Temperature (°C) = 45 - 25 = 20 °C
- 2) Change in Frequency = - 0.042 ppm*(Δ°C)
= - 0.042 ppm*(20)²
= - 16.8 ppm(max)

GLOBAL PART NUMBER												
X	T	2	6	T	T	A	3	2	K	7	6	8
MODEL				OPERATING TEMPERATURE	PACKAGE CODE	FREQUENCY						

Tuning Fork Crystal



The tuning fork type quartz crystal provides ultimate in size, performance and economic trade-offs. So it is used as a clock source in communication equipment, measuring instrument, microprocessor and other time management applications.

FEATURES

- Miniature package
- Low cost
- KHz frequency
- Tight tolerance
- 100 % Lead (Pb)-free and RoHS compliant



RoHS
COMPLIANT

STANDARD ELECTRICAL SPECIFICATIONS						
PARAMETER	SYMBOL	CONDITION	UNIT	MIN	TYPICAL	MAX
Frequency Range	F _O		KHz		32.768	
Frequency Tolerance	ΔF/F _O	at 25°C	ppm		± 20	
Frequency Coefficient	K	ref to 25°C	ppm/(Δ°C) ²			- 0.042
Operating Temperature Range	T _{OPR}		°C	- 10		+ 60
Storing Temperature Range	T _{STG}		°C	- 20		+ 70
Shunt Capacitance	C _O		pF		0.85	2
Motional Capacitance	C ₁		fF	1	2	4
Load Capacitance	CL		pF		12.5	
Insulation Resistance	IR	100V _{DC}	MΩ	500		
Drive Level	DL		μW			1
Aging (first year)	Fa	at 25°C ± 3°C	ppm	- 5.0		+ 5.0
Equivalent Series Resistance(ESR)	Rs		KΩ			35

DIMENSIONS in inches [millimeters]

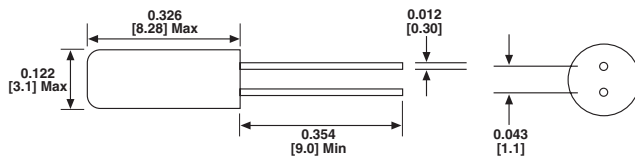

PARABOLIC TEMPERATURE CURVE

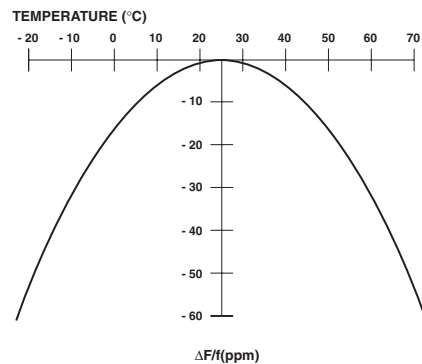

To determine frequency stability, use parabolic curvature (k).
For example: What is stability at 45°C?

- 1) Change in Temperature (°C) = 45 - 25 = 20°C
- 2) Change in Frequency = - 0.042ppm*(Δ°C)
= - 0.042ppm*(20)²
= - 16.8ppm(max)

ORDERING INFORMATION		
XT38T	32.768KHz	e2
MODEL	FREQUENCY/KHz	JEDEC LEAD FREE STANDARD

GLOBAL PART NUMBER												
X	T	3	8	T	T	A	3	2	K	7	6	8
MODEL				OPERATING TEMPERATURE		PACKAGE CODE	FREQUENCY					

Miniature SMD Watch Crystal



The XT38P is a 2.5 mm height plastic molded 32.768 KHz SMD crystal unit. This thermoplastic molded rugged part is perfect for your SMD applications in limited circuit space using the watch frequency.

FEATURES

- 2.5 mm height
- Industry standard footprint
- Long term stability
- Tape and reel, 3000 pcs
- 100 % Lead (Pb)-free and RoHS compliant



RoHS
COMPLIANT

STANDARD ELECTRICAL SPECIFICATIONS						
PARAMETER	SYMBOL	CONDITION	UNIT	MIN	TYPICAL	MAX
Frequency Range	F _O		KHz		32.768	
Frequency Tolerance	ΔF/F _O	at 25 °C	ppm	-20		+20
Frequency Coefficient	K	parabolic coefficient	ppm/°C ²	-0.027	-0.035	-0.043
Operating Temperature Range	T _{OPR}		°C	-40		+85
Storing Temperature Range	T _{STG}		°C	-55		+125
Shunt Capacitance	C _O		pF		1.0	
Motional Capacitance	C ₁		fF		2.0	
Load Capacitance	CL		pF		12.5	
Insulation Resistance	IR		MΩ	500		
Drive Level	DL		μW			1.0
Aging (first year)	Fa	at 25 °C ± 3 °C	ppm		±3.0	
Equivalent Series Resistance(ESR)	Rs		KΩ			50

DIMENSIONS in inches [millimeters]

XT38PA

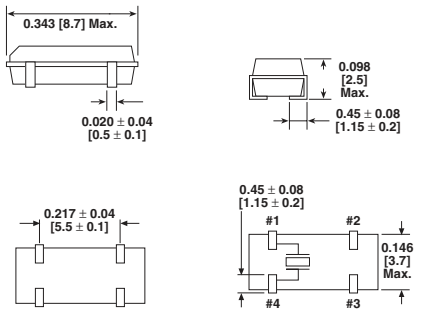

PARABOLIC TEMPERATURE CURVE

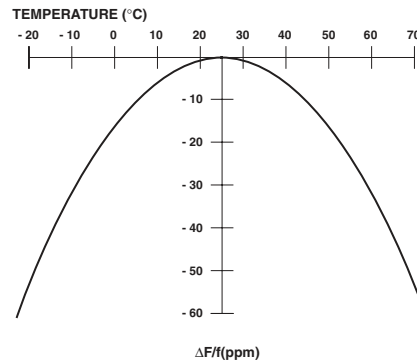

ORDERING INFORMATION			
XT38P	A	32.768 KHz	e6
MODEL	PAD LAYOUT	FREQUENCY/KHz	JEDEC Lead (Pb)-Free STANDARD

To determine frequency stability, use parabolic curvature (k).
For example: What is stability at 45 °C?

- 1) Change in Temperature (°C) = 45 - 25 = 20 °C
- 2) Change in Frequency = - 0.042 ppm*(Δ°C)
= - 0.042 ppm*(20)²
= - 16.8 ppm(max)

GLOBAL PART NUMBER												
X	T	3	8	P	A	A	3	2	K	7	6	8
MODEL					PAD LAYOUT	PACKAGE CODE	FREQUENCY					

Surface Mount Watch Crystal



The XT32P is a cylinder type watch crystal molded in a thermoplastic housing capable of withstanding soldering re-flow processing. The XT32P is perfect for your SMD applications using the 32.768 KHz frequency. We offer two different footprints of the part to satisfy various pattern layout requirements.

FEATURES

- Low profile
- Industry standard footprint
- Long term stability
- Tape and reel, 2000pcs
- 100 % Lead (Pb)-free and RoHS compliant



STANDARD ELECTRICAL SPECIFICATIONS

PARAMETER	SYMBOL	CONDITION	UNIT	MIN	TYPICAL	MAX
Frequency Range	F _O		KHz		32.768	
Frequency Tolerance	ΔF/F _O	at 25 °C	ppm	-20		+20
Frequency Coefficient	K	parabolic coefficient	ppm/°C ²	-0.027	-0.035	-0.043
Operating Temperature Range	T _{OPR}		°C	-40		+85
Storing Temperature Range	T _{STG}		°C	-55		+125
Shunt Capacitance	C _O		pF		1.0	
Motional Capacitance	C ₁		fF		2.0	4
Load Capacitance	CL		pF		12.5	
Insulation Resistance	IR		MΩ	500		
Drive Level	DL		μW			1.0
Aging (first year)	Fa	at 25 °C ± 3 °C	ppm		±3.0	
Equivalent Series Resistance(ESR)	Rs		KΩ			50

DIMENSIONS in inches [millimeters]

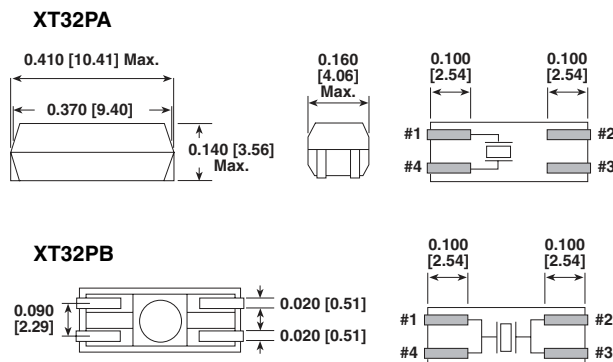

PARABOLIC TEMPERATURE CURVE

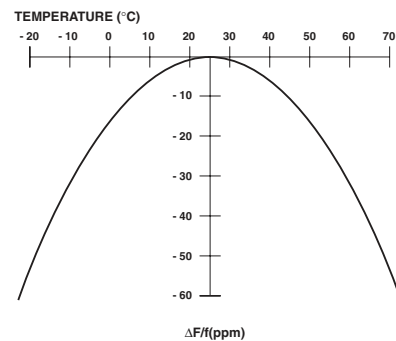

To determine frequency stability, use parabolic curvature (k).
For example: What is stability at 45 °C?

- 1) Change in Temperature (°C) = 45 - 25 = 20 °C
- 2) Change in Frequency = - 0.042 ppm*(Δ°C)
= - 0.042 ppm*(20)²
= - 16.8 ppm(max)

ORDERING INFORMATION

XT32P	A	32.768 KHz	e6
MODEL	PAD LAYOUT A or B	FREQUENCY /KHz	JEDEC Lead (Pb)- Free STANDARD

GLOBAL PART NUMBER

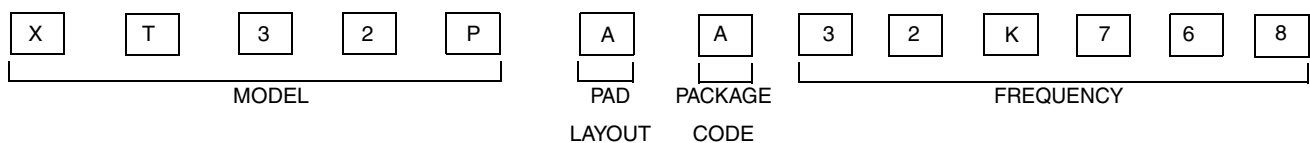

Resistance Welded Holder Type Crystal Unit



The XT49U series is an industry standard AT cut crystal housed in a HC-49U package. It is our standard resistance weld type quartz crystal.

FEATURES

- Low cost
- Industry standard
- Excellent aging
- Wide frequency range
- 'AT' cut crystal
- 100 % Lead (Pb)-free and RoHS compliant



RoHS
COMPLIANT

STANDARD ELECTRICAL SPECIFICATIONS						
PARAMETER	SYMBOL	CONDITION	UNIT	MIN	TYPICAL	MAX
Frequency Range	F_O		MHz	1.8432		125
Frequency Tolerance	$\Delta F/F_O$	at 25 °C	ppm	± 10	± 30	± 50
Temperature Stability	TC	ref to 25 °C	ppm	± 10	± 30	± 50
Operating Temperature Range	T_{OPR}		°C	-20		+70
Storing Temperature Range	T_{STG}		°C	-40		+85
Shunt Capacitance	C_O		pF			7
Load Capacitance	CL	Customer Specified	pF	10		Series
Insulator Resistance	IR	100 V_{DC}	$M\Omega$	500		
Drive Level	DL		μW		100	500
Aging	Fa	at 25 °C, per year	ppm	-5.0		+5.0

EQUIVALENT SERIES RESISTANCE (ESR) AND MODE OF VIBRATION (MODE)					
FREQUENCY RANGE (MHZ)	MAX ESR (Ω)	MODE	FREQUENCY RANGE (MHZ)	MAX ESR (Ω)	MODE
1.8432 to 1.999	650	Fundamental	6.000 to 7.999	50	Fundamental
2.000 to 2.999	500	Fundamental	8.000 to 12.999	35	Fundamental
3.000 to 3.499	250	Fundamental	13.000 to 32.000	25	Fundamental
3.500 to 3.999	150	Fundamental	24.000 to 29.999	60	3 rd Overtone
4.000 to 4.999	100	Fundamental	30.000 to 79.999	40	3 rd Overtone
5.000 to 5.999	80	Fundamental	80.000 to 125.000	90	5 th Overtone

DIMENSIONS in inches [millimeters]

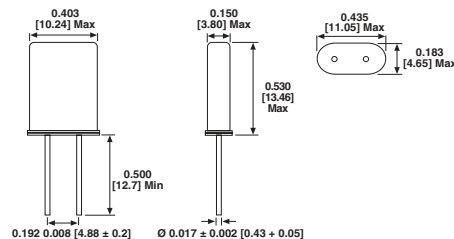

ORDERING INFORMATION					
XT49U MODEL	R OTR Blank = Standard R = -40 °C to +85 °C	-20 LOAD Blank = Series -16 = 16 pF -20 = 20 pF -30 = 30 pF -32 = 32 pF	SP OPTIONS Blank = Standard SL = Sleeve SP = Spacer	M FREQUENCY/MHz	e2 JEDEC Lead (Pb)-Free STANDARD

GLOBAL PART NUMBER										
X	T	9	U	2	0	A	N	A	4	M
MODEL				LOAD		PACKAGE CODE	OPTION		FREQUENCY	

Low Profile Holder Type Crystal Units



This part is a miniature AT cut strip crystal unit with a low profile package. It is with resistance weld.

FEATURES

- Low cost
- Industry standard
- Wide frequency range
- Excellent aging
- 100 % Lead (Pb)-free and RoHS compliant



STANDARD ELECTRICAL SPECIFICATIONS						
PARAMETER	SYMBOL	CONDITION	UNIT	MIN	TYPICAL	MAX
Frequency Range	F ₀		MHz	3.200		66.000
Frequency Tolerance	ΔF/F ₀	at 25 °C	ppm	±10	±30	±50
Temperature Stability	TC	ref to 25 °C	ppm	±10	±30	±50
Operating Temperature Range	T _{OPR}		°C	-20		+70
Storing Temperature Range	T _{STG}		°C	-40		+85
Shunt Capacitance	C ₀		pF			7
Load Capacitance	CL	Customer Specified	pF	10		Series
Insulator Resistance	IR	100 V _{DC}	MΩ	500		
Drive Level	DL		μW		100	500
Aging (first year)	Fa	at 25 °C, per year	ppm	-5.0		+5.0

EQUIVALENT SERIES RESISTANCE (ESR) AND MODE OF VIBRATION (MODE)					
FREQUENCY RANGE (MHZ)	MAX ESR (Ω)	MODE	FREQUENCY RANGE (MHZ)	MAX ESR (Ω)	MODE
3.200 to 4.499	150	Fundamental/AT	9.000 to 9.999	60	Fundamental/AT
4.500 to 5.999	120	Fundamental/AT	10.000 to 12.999	50	Fundamental/AT
6.000 to 6.999	100	Fundamental/AT	13.000 to 30.000	40	Fundamental/AT
7.000 to 7.999	90	Fundamental/AT	30.000 to 66.000	80	3rd Overtone
8.000 to 8.999	80	Fundamental/AT			

DIMENSIONS in inches [millimeters]

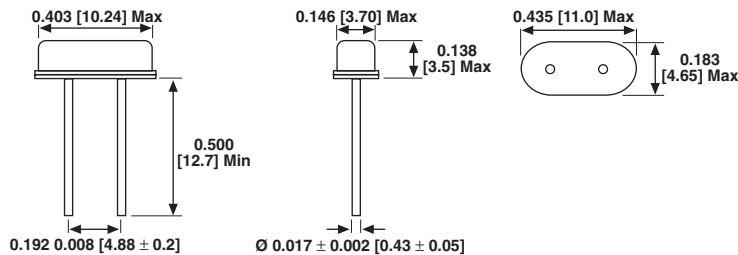

ORDERING INFORMATION					
XT49S	R	-20	SP	12 M	e2
MODEL	OTR	LOAD	OPTIONS	FREQUENCY/MHz	JEDEC Lead (Pb)-Free STANDARD
	Blank = Standard R = -40 °C to +85 °C	Blank = Series -16 = 16 pF -20 = 20 pF Standard -30 = 30 pF -32 = 32 pF	Blank = Standard SP = Spacer SL = Sleeve		

GLOBAL PART NUMBER						
X	T	9	S			
MODEL				2	0	
				LOAD		
				A		
				PACKAGE		
				N	A	
				OPTIONS		
				1	2	M
				FREQUENCY		
CODE						

Low Profile Holder Type Crystal Units



FEATURES

- Low cost
- Industry standard
- Wide frequency range
- Excellent aging
- 100 % Lead (Pb)-free and RoHS compliant



RoHS
COMPLIANT

This part is a miniature AT cut strip crystal unit with a low profile package. It is with resistance weld.

STANDARD ELECTRICAL SPECIFICATIONS						
PARAMETER	SYMBOL	CONDITION	UNIT	MIN	TYPICAL	MAX
Frequency Range	F_O		MHz	3.200		66.000
Frequency Tolerance	$\Delta F/F_O$	at 25 °C	ppm	± 10	± 30	± 50
Temperature Stability	TC	ref to 25 °C	ppm	± 10	± 30	± 50
Operating Temperature Range	T_{OPR}		°C	-20		+70
Storing Temperature Range	T_{STG}		°C	-40		+85
Shunt Capacitance	C_O		pF			7
Load Capacitance	CL	Customer Specified	pF	10		Series
Insulator Resistance	IR	100 V_{DC}	$M\Omega$	500		
Drive Level	DL		μW		100	500
Aging (first year)	Fa	at 25 °C, per year	ppm	-5.0		+5.0

EQUIVALENT SERIES RESISTANCE (ESR) AND MODE OF VIBRATION (MODE)					
FREQUENCY RANGE (MHZ)	MAX ESR (Ω)	MODE	FREQUENCY RANGE (MHZ)	MAX ESR (Ω)	MODE
3.200 to 4.499	150	Fundamental/AT	9.000 to 9.999	60	Fundamental/AT
4.500 to 5.999	120	Fundamental/AT	10.000 to 12.999	50	Fundamental/AT
6.000 to 6.999	100	Fundamental/AT	13.000 to 30.000	40	Fundamental/AT
7.000 to 7.999	90	Fundamental/AT	30.000 to 66.000	80	3rd Overtone
8.000 to 8.999	80	Fundamental/AT			

DIMENSIONS in inches [millimeters]

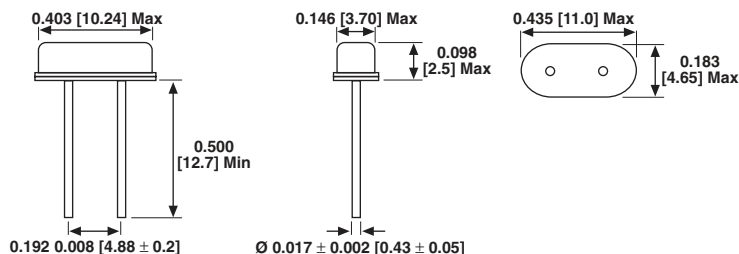

ORDERING INFORMATION					
XT49SL MODEL	R OTR Blank = Standard R = -40 °C to +85 °C	-20 LOAD Blank = Series -16 = 16 pF -20 = 20 pF Standard -30 = 30 pF -32 = 32 pF	SP OPTIONS Blank = Standard SP = Spacer SL = Sleeve	12 M FREQUENCY/MHz	e2 JEDEC Lead (Pb)-Free STANDARD

GLOBAL PART NUMBER												
X	T	9	S	L	2	0	A	N	A	1	2	M
MODEL					LOAD		PACKAGE	OPTIONS		FREQUENCY		
CODE												

Low Profile SMD Type Crystal Units



This part is a miniature AT cut strip crystal unit packaged for surface mounting.

FEATURES

- Low cost
- Industry standard
- Wide frequency range
- Excellent aging
- Surface mount
- 100 % Lead (Pb)-free and RoHS compliant



STANDARD ELECTRICAL SPECIFICATIONS						
PARAMETER	SYMBOL	CONDITION	UNIT	MIN	TYPICAL	MAX
Frequency Range	F _o		MHz	3.200		66.000
Frequency Tolerance	ΔF/F _o	at 25 °C	ppm	±10	±30	±50
Temperature Stability	TC	ref to 25 °C	ppm	±10	±30	±50
Operating Temperature Range	T _{OPR}		°C	-20		+70
Storage Temperature Range	T _{STG}		°C	-40		+85
Shunt Capacitance	C _o		pF			7
Load Capacitance	CL	Customer Specified	pF	10		Series
Insulator Resistance	IR	100 V _{DC}	MΩ	500		
Drive Level	DL		μW		100	500
Aging	Fa	at 25 °C, per year	ppm	-5.0		+5.0

EQUIVALENT SERIES RESISTANCE (ESR) AND MODE OF VIBRATION (MODE)					
FREQUENCY RANGE (MHZ)	MAX ESR (Ω)	MODE	FREQUENCY RANGE(MHZ)	MAX ESR (Ω)	MODE
3.200 to 4.499	150	Fundamental/AT	9.000 to 9.999	60	Fundamental/AT
4.500 to 5.999	120	Fundamental/AT	10.000 to 12.999	50	Fundamental/AT
6.000 to 6.999	100	Fundamental/AT	13.000 to 30.000	40	Fundamental/AT
7.000 to 7.999	90	Fundamental/AT	30.000 to 66.000	80	3 rd Overtone
8.000 to 8.999	80	Fundamental/AT			

DIMENSIONS in inches [millimeters]

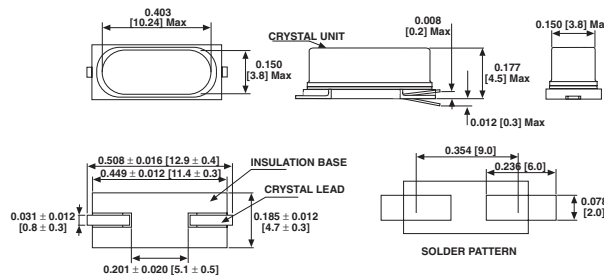

ORDERING INFORMATION

XT49 M
MODEL

R
OTR
Blank = Standard
R = -40 °C to +85 °C

-20
LOAD
Blank = Series
-20 = 20 pF
-30 = 30 pF
-32 = 32 pF

20 M
FREQUENCY/MHZ

e2
JEDEC LEAD (PB)-
FREE
STANDARD

GLOBAL PART NUMBER

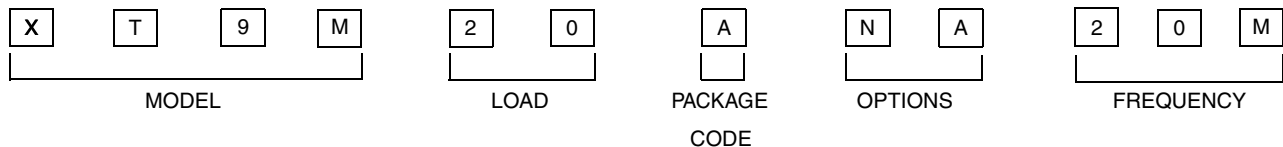

Low Profile SMD Type Crystal Units



FEATURES

- Low cost
- Industry standard
- Wide frequency range
- Excellent aging
- Surface mount
- 100 % Lead (Pb)-free and RoHS compliant



RoHS
COMPLIANT

This part is a miniature AT cut strip crystal unit packaged for surface mounting.

STANDARD ELECTRICAL SPECIFICATIONS						
PARAMETER	SYMBOL	CONDITION	UNIT	MIN	TYPICAL	MAX
Frequency Range	F_o		MHz	3.200		66.000
Frequency Tolerance	$\Delta F/F_o$	at 25 °C	ppm	± 10	± 30	± 50
Temperature Stability	TC	ref to 25 °C	ppm	± 10	30	± 50
Operating Temperature Range	T_{OPR}		°C	-20		+70
Storage Temperature Range	T_{STG}		°C	-40		+85
Shunt Capacitance	C_o		pF			7
Load Capacitance	CL	Customer Specified	pF	10		Series
Insulator Resistance	IR	100 V_{DC}	M Ω	500		
Drive Level	DL		μW		100	500
Aging	Fa	at 25 °C, per year	ppm	-5.0		+5.0

EQUIVALENT SERIES RESISTANCE (ESR) AND MODE OF VIBRATION (MODE)					
FREQUENCY RANGE(MHZ)	MAX ESR(Ω)	MODE	FREQUENCY RANGE(MHZ)	MAX ESR(Ω)	MODE
3.200 to 4.499	150	Fundamental/AT	9.000 to 9.999	60	Fundamental/AT
4.500 to 5.999	120	Fundamental/AT	10.000 to 12.999	50	Fundamental/AT
6.000 to 6.999	100	Fundamental/AT	13.000 to 30.000	40	Fundamental/AT
7.000 to 7.999	90	Fundamental/AT	30.000 to 66.000	80	3 rd Overtone
8.000 to 8.999	80	Fundamental/AT			

DIMENSIONS in inches [millimeters]

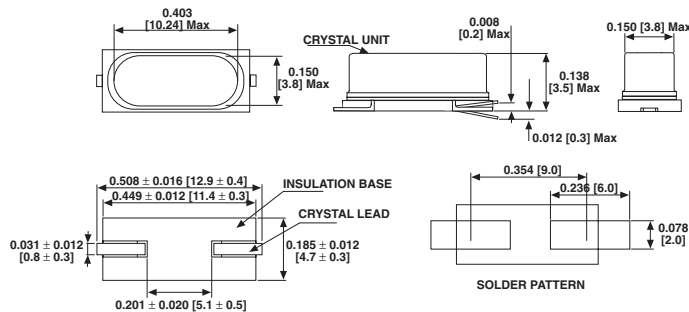

ORDERING INFORMATION				
XT49ML MODEL	R OTR Blank = Standard R = -40 °C to +85 °C	-20 LOAD Blank = Series -20 = 20 pF -30 = 30 pF -32 = 32 pF	20 FREQUENCY/MHz	e2 JEDEC Lead (Pb)-Free STANDARD

GLOBAL PART NUMBER												
X	T	9	M	L	2	0	A	N	A	2	0	M
MODEL					LOAD		CODE	OPTIONS		FREQUENCY		

Resistance Welded Miniature Crystal Units

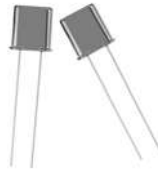

The XTUM-1 crystal unit is a miniature resistance welded package that provides excellent hermetic seal and frequency aging. The frequency range till 125 Mhz and miniature size is ideal for communication equipment.

FEATURES

- Low cost
- Industry standard
- Small compact size
- Wide frequency range
- High stability
- 'AT' cut crystal
- 100 % Lead (Pb)-free and RoHS compliant



RoHS
COMPLIANT

STANDARD ELECTRICAL SPECIFICATIONS

PARAMETER	SYMBOL	CONDITION	UNIT	MIN	TYPICAL	MAX
Frequency Range	F _O		MHz	10		125
Frequency Tolerance	ΔF/F _O	at 25 °C	ppm		±10	±50
Temperature Stability	TC	see Frequency Stability vs Temperature Range	ppm		±10	±50
Operating Temperature Range	T _{OPR}		°C			
Storing Temperature Range	T _{STG}		°C	-40		+85
Shunt Capacitance	C _O		pF			7
Load Capacitance	CL	Customer Specified	pF	10		Series
Insulator Resistance	IR	100 V _{DC}	MΩ	500		
Drive Level	DL		μW		100	500
Aging	Fa	at 25 °C, per year	ppm	-5.0		+5.0

EQUIVALENT SERIES RESISTANCE (ESR) AND MODE OF VIBRATION (MODE)

FREQUENCY RANGE (Mhz)	MAX ESR (Ω)	MODE
10.000 to 12.999	60	Fundamental
13.000 to 19.999	40	Fundamental
20.000 to 29.999	30	Fundamental
30.000 to 39.999	60	Fundamental
40.000 to 59.999	50	Fundamental
60.000 to 79.999	50	3 rd Overtone
80.000 to 125.000	100	5 th Overtone

FREQUENCY STABILITY VS TEMPERATURE RANGE(25 °C ± 3 °C)

TEMPERATURE RANGE (°C)	FREQUENCY STABILITY(PPM)					
	±5	±10	±15	±20	±30	±50
0 to 50	x	x	x	x	x	x
-10 to 60	x	x	x	x	x	x
-20 to 70		x	x	x	x	x
-40 to 85				x	x	x

DIMENSIONS in inches [millimeters]

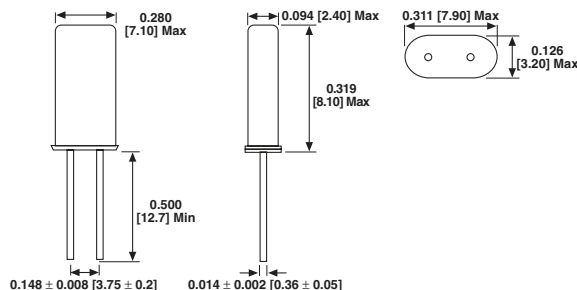

ORDERING INFORMATION

XTUM1 MODEL	-18 LOAD	20 M FREQUENCY/MHz	e2 JEDEC
	Blank = Series -32 = 32 pF -18 = 18 pF Standard		Lead (Pb)-Free STANDARD

GLOBAL PART NUMBER

X	T	U	1	1	8	A	N	A	2	0	M
MODEL				LOAD		PACKAGE CODE	OPTIONS		FREQUENCY		

Surface Mount Crystal



FEATURES

- Miniature size
- Wide frequency range
- Glass sealing
- Emboss taping
- Lead (Pb)-free terminations and RoHS compliant



RoHS
COMPLIANT

This XT36C part is a miniature SMD crystal with 8.0 x 4.5 ceramic package and a height of 1.6 mm max. It is widely applied in notebook computer, PCMCIA and communication equipment.

STANDARD ELECTRICAL SPECIFICATIONS						
PARAMETER	SYMBOL	CONDITION	UNIT	MIN	TYPICAL	MAX
Frequency Range	F _O		MHz	10.000		80.000
Frequency Tolerance	ΔF/F _O	at 25 °C	ppm	±30	±50	±100
Temperature Stability	TC	ref to 25 °C	ppm	±30	±50	±100
Operating Temperature Range	T _{OPR}		°C	-10		+70
Storage Temperature Range	T _{STG}		°C	-40		85
Shunt Capacitance	C _O		pF			7
Load Capacitance	CL	Customer Specified	pF	10		Series
Insulator Resistance	IR	100 V _{DC}	MΩ	500		
Drive Level	DL		μW		100	300
Aging	Fa	at 25 °C, per year	ppm	-5.0		+5.0

EQUIVALENT SERIES RESISTANCE (ESR) AND MODE OF VIBRATION (MODE)		
FREQUENCY RANGE (MHz)	MAX ESR (Ω)	MODE
10.000 to 11.999	80	Fundamental
12.000 to 39.999	50	Fundamental
40.000 to 80.000	70	3 rd Overtone

DIMENSIONS in inches [millimeters]

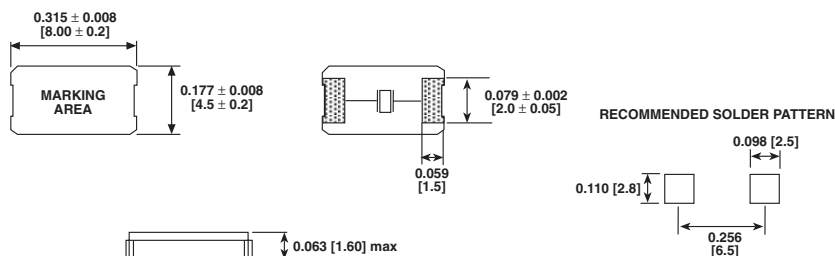

ORDERING INFORMATION			
XT36C MODEL	-20 LOAD Blank = Series 12 = 12 pF 16 = 16 pF 20 = 20 pF 32 = 32 pF	24 M FREQUENCY/MHz	e4 JEDEC Lead (Pb)- Free STANDARD

GLOBAL PART NUMBER			
X	T	3	6
MODEL			
2	0	A	2
LOAD		PACKAGE	CODE
4	M	2	
FREQUENCY			

Quartz Crystals

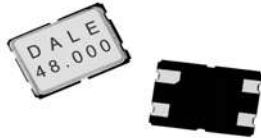

The XT57C is a miniature SMD crystal with 7.0 x 5.0 ceramic package and a height of 1.1 mm max. 9.8304 MHz to 100 MHz frequency makes it widely applied in notebook computer, PCMCIA and communication equipment.

FEATURES

- Miniature size
- 1.1 mm height
- Wide frequency range
- Seam sealing
- Emboss taping
- 100 % Lead (Pb)-free and RoHS compliant

RoHS
COMPLIANT

STANDARD ELECTRICAL SPECIFICATIONS						
PARAMETER	SYMBOL	CONDITION	UNIT	MIN	TYPICAL	MAX
Frequency Range	F_0		MHz	9.8304		100.000
Frequency Tolerance	$\Delta F/F_0$	at 25 °C	ppm	±10	±30	±50
Temperature Stability	TC	ref to 25 °C	ppm	±10	±30	±50
Operating Temperature Range	T_{OPR}		°C	-10		+60
Storage Temperature Range	T_{STG}		°C	-40		+85
Shunt Capacitance	C_0		pF			7
Load Capacitance	CL	Customer Specified	pF	10		Series
Insulator Resistance	IR	100 V_{DC}	$M\Omega$	500		
Drive Level	DL		μW		100	300
Aging	Fa	at 25 °C, per year	ppm	-5.0		+5.0

EQUIVALENT SERIES RESISTANCE (ESR) AND MODE OF VIBRATION (MODE)		
FREQUENCY RANGE (MHz)	MAX ESR (Ω)	MODE
9.8304 to 15.999	60	Fundamental
16.000 to 39.999	40	Fundamental
40.000 to 83.999	60	3 rd Overtone
84.000 to 100.000	80	3 rd Overtone

DIMENSIONS in inches [millimeters]

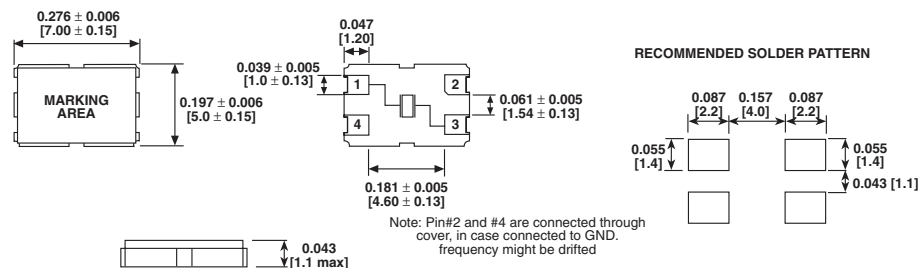

ORDERING INFORMATION			
XT57C MODEL	-20 LOAD Blank = Series 20 = 20 pF 32 = 32 pF 16 = 16 pF	2 M FREQUENCY/MHz	e4 JEDEC Lead (Pb)- Free STANDARD

GLOBAL PART NUMBER			
X	T	5	7
MODEL			
2	0	A	2
LOAD		PACKAGE CODE	5
FREQUENCY			
M			

Surface Mount Crystal



This part is an ultra miniature package with size of 6.0 x 3.5 x 1.0 mm. With its ceramic base and metal cover it provides the durability and reliability necessary for strenuous process like infrared and vapor phase reflow.

FEATURES

- Ultra-miniature size
- Wide frequency range
- Seam sealing
- Ceramic package
- Emboss tapping
- Reflow soldering
- 100 % Lead (Pb)-free and RoHS compliant



RoHS
COMPLIANT

STANDARD ELECTRICAL SPECIFICATIONS						
PARAMETER	SYMBOL	CONDITION	UNIT	MIN	TYPICAL	MAX
Frequency Range	F_O		MHz	10.000		80.000
Frequency Tolerance	$\Delta F/F_O$	at 25 °C	ppm	±10	±30	±50
Temperature Stability	TC	ref to 25 °C	ppm	±10	±30	±50
Operating Temperature Range	T_{OPR}		°C	-10		+60
Storing Temperature Range	T_{STG}		°C	-40		+85
Shunt Capacitance	C_O		pF			7
Load Capacitance	CL	Customer Specified	pF	10		Series
Insulator Resistance	IR	100 V_{DC}	$M\Omega$	500		
Drive Level	DL		μW		100	300
Aging	Fa	at 25 °C, per year	ppm	-5.0		+5.0

EQUIVALENT SERIES RESISTANCE (ESR) AND MODE OF VIBRATION (MODE)		
FREQUENCY RANGE (MHZ)	MAX ESR (Ω)	MODE
10.000 to 15.999	60	Fundamental
16.000 to 39.999	40	Fundamental
40.000 to 80.000	70	3 rd Overtone

DIMENSIONS in inches [millimeters]

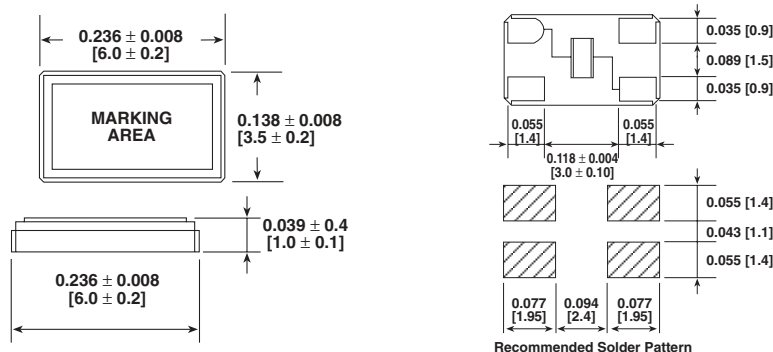

ORDERING INFORMATION			
XT46C MODEL	-20 LOAD Blank = Series -20 = 20 pF Standard -32 = 32 pF	25 M FREQUENCY/MHz	e4 JEDEC Lead (Pb)-Free STANDARD

GLOBAL PART NUMBER			
X	T	4	6
MODEL			
2	0	A	2
LOAD		PACKAGE CODE	2
5	M	FREQUENCY	



Oscillators

OSCILLATOR

An oscillator is a circuit that generates an output signal through feedback and amplification.

CLOCK OSCILLATOR

A clock oscillator is a device that establishes a reference frequency for timing purposes such as sequencing events in a computer.

LOGIC

This is the terminology used for families of active devices used in the manufacturing of clock oscillator. The most popular are TTL, HCMOS, CMOS, and ECL.

LOAD/FAN-OUT

The maximum load, specified in number of gates or in maximum load capacity, that a family of oscillators can drive is defined as the output load of driving capability.

RISE TIME

The rise time is defined as the transition time of the output waveform from low state to high state.

FALL TIME

The fall time is defined as the transition time of the output waveform from high state to low state.

SYMMERTY

Symmetry is the time the waveform is above the threshold vs. below the threshold. 50/50 is perfect symmetry.

TRI-STATE

The tri-state option allows the oscillator to be isolated from the circuit upon application of a command signal. When this feature is activated, the output goes to a high impedance state.

SUPPLY VOLTAGE

The DC input voltage necessary for oscillator operation.











INPUT CURRENT







The amount of current consumed by an oscillator from the power supply.

FREQUENCY STABILITY (Variation of Frequency from nominal.)

This is inclusive of calibration tolerance at 25 °C, temperature change, input voltage change, load change, aging, shock, and vibration.

Oscillators

SELECTOR GUIDE - OSCILLATORS				
PRODUCT	FREQUENCY RANGE	FREQUENCY STABILITY	TEMPERATURE RANGE	KEY FEATURES
XO-53 	1 to 100 MHz	100/50/25 ppm	0 to +70 °C (-40 to +85 °C)	TTL Compatible 14 Pin Dip
XO-54 	1 to 100 MHz	100/50/25 ppm	0 to +70 °C (-40 to +85°C)	14 Pin Dip HCMOS/TTL Compatible Tristate Output Available
XO-543 	1 to 100 MHz	100/50/25 ppm	0 to +70 °C (-40 to +85 °C)	3.3 V Operation HCMOS/TTL Compatible Tristate Output Available
XO-52 	1 to 100 MHz	100/50/25 ppm	0 to +70 °C (-40 to +85°C)	8 Pin Dip HCMOS/TTL Compatible Tristate Output Available
XO-523 	1 to 100 MHz	100/50/25 ppm	0 to +70 °C (-40 to +85°C)	3.3 V Operation HCMOS/TTL Compatible Tristate Output Available
XO-56 	1 to 999.9 KHz	100/50/25 ppm	0 to +70 °C (-40 to +85°C)	Low Frequency HCMOS/TTL Compatible 14 Pin Dip
XOVC-23 	1 to 40 MHz	100/50/25 ppm	0 to +70 °C (-40 to +85 °C)	Voltage Control HCMOS/TTL Compatible
XOSM-52 	1 to 100 MHz	100/50/25 ppm	0 to +70 °C (-40 to +85 °C)	Surface Mount HCMOS/TTL Compatible Tristate Output Available
XOSM-55 	1 to 100 MHz	100/50/25 ppm	0 to +70 °C (-40 to +85 °C)	Surface Mount 5 V Operation HCMOS/TTL Tristate Output
XOSM-553 	1 to 100 MHz	100/50/25 ppm	0 to +70 °C (-40 to +85 °C)	Surface Mount 3.3 V Operation HCMOS/TTL Tristate Output

SELECTOR GUIDE - OSCILLATORS				
PRODUCT	FREQUENCY RANGE	FREQUENCY STABILITY	TEMPERATURE RANGE	KEY FEATURES
XOSM-57 	1 to 100 MHz	100/50/25 ppm	0 to +70 °C (-40 to +85 °C)	Surface Mount HCMOS/TTL Compatible Tristate Output
XOSM-573 	1 to 100 MHz	100/50/25 ppm	0 to +70 °C (-40 to +85 °C)	Surface Mount 3.3 V Operation HCMOS/TTL Tristate Output
XOSM-572 	1 to 100 MHz	100/50/25 ppm	0 to +70 °C (-40 to +85 °C)	Surface Mount 2.5 V Operation HCMOS/TTL Tristate Output
XOSM-571 	1 to 100 MHz	100/50/25 ppm	0 to +70 °C (-40 to +85 °C)	Surface Mount 1.8 V Operation HCMOS/TTL Tristate Output
XOSM-533 	1 to 100 MHz	100/50/25 ppm	0 to +70 °C (-40 to +85 °C)	Surface Mount 3.3 V Operation HCMOS/TTL Tristate Output
XOSM-532 	1 to 100 MHz	100/50/25 ppm	0 to +70 °C (-40 to +85 °C)	Surface Mount 2.5 V Operation HCMOS/TTL Tristate Output
XOSM-531 	1 to 100 MHz	100/50/25 ppm	0 to +70 °C (-40 to +85 °C)	Surface Mount 1.8 V Operation HCMOS/TTL Tristate Output

Global Part Numbering Oscillators

GLOBAL PART NUMBERING												
X	O	5	2	C	T	E	L	N	A	4	0	M
MODEL NUMBER	FREQUENCY STABILITY	OPERATING TEMPERATURE (OTR)		ENABLE/DISABLE	PACKAGE CODE	OPTIONS	FREQUENCY					
XO53 = XO-53 XO54 = XO-54 XO34 = XO-543 XO52 = XO-52 XO32 = XO-523 XO56 = XO-56 XOVC = XOVC-23 XO5M = XOSM-52 XO63 = XOSM-533 XO62 = XOSM-532 XO61 = XOSM-531 XO57 = XOSM-57 XO37 = XOSM-573 XO27 = XOSM-572 XO17 = XOSM-571 XO55 = XOSM-55 XO35 = XOSM-553	C = 0.01% (100 ppm) D = 0.005% (50 ppm) E = 0.0025% (25 ppm)	T = 0 °C to +70 °C R = -40 °C to +85 °C		F = Pin 1 Open E = Disable to Tristate	TAPE AND REEL H = RF7 BULK A = B04 (X063, X062, X061) C = D06 (X057, X037, X027, XO17) D = D07 (X053, X054, X034, XO56, XOVC, X055, XO35) L = D08 (X052, X032, X05M)	NA = No Additional Options 60 = 45/55 Symmetry Contact factory for all other options	4M = 4 MHz 40M = 40 MHz 100M = 100 MHz 12M288 = 12.288 MHz M is used as decimal place holder in frequency					

Example: XO52CTELNA40M

Full Size Clock Oscillators TTL Compatible



The XO-53 series oscillator is TTL compatible and features fast rise/fall times with high reliability at low cost. The metal package with pin#7 case ground acts as shielding to minimize EMI radiation.

FEATURES

- 10TTL output load
- 14 pin fill size
- Industry standard
- Wide frequency range
- Low cost
- Resistance weld package
- Lead (Pb)-free terminations and RoHS compliant



STANDARD ELECTRICAL SPECIFICATIONS			
PARAMETER	SYMBOL	CONDITION	XO-53
Frequency Range	F_O		1.0 MHz ~ 100.00 MHz
Frequency Stability*		All Condition*	± 25 ppm, ± 50 ppm, ± 100 ppm
Operating Temperature Range	T_{OPR}		0 °C ~ 70 °C (-40 °C ~ +85 °C option)
Storage Temperature Range	T_{STG}		-55 °C ~ +125 °C
Power Supply Voltage	V_{DD}		5.0 V \pm 10 %
Aging (First Year)		25 °C \pm 3 °C	± 5 ppm
Supply Current	I_{DD}	1.0 MHz to 23.999 MHz	15 mA Max
		24.000 MHz to 69.999 MHz	30 mA Max
		70.000 MHz to 100.000 MHz	60 mA Max
Output Symmetry	Sym	At 1.4 V	40/60 % (45/55 % Option)
Rise Time	T_r	0.4 V ~ 2.4 V	5 nS Max
Fall Time	T_f	2.4 V ~ 0.4 V	5 nS Max
Output Voltage	V_{OH}		2.4 V Min
	V_{OL}		0.4 V Max
Output Load	TTL Load		1 ~ 10 TTL
Start-up Time		T_s	10 mS Max

* Include: 25 °C tolerance, operating temperature range, input voltage change, aging, load change, shock and vibration.

DIMENSIONS in inches [millimeters]

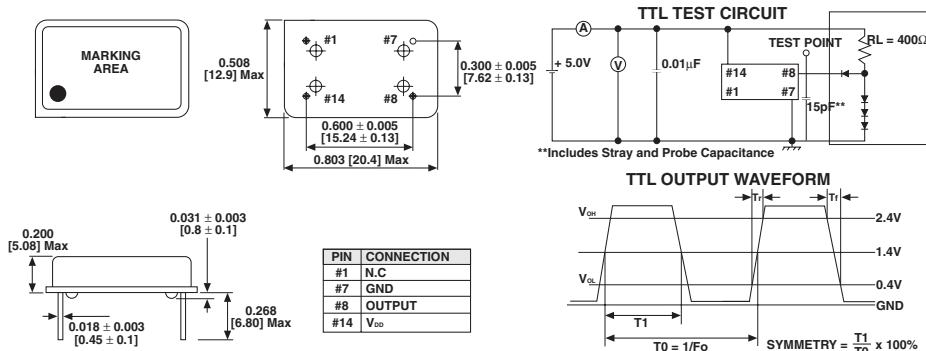

ORDERING INFORMATION

XO-53 MODEL	B FREQUENCY STABILITY	R OTR	40 M FREQUENCY/MHz	e2 JEDEC Lead (Pb)-Free STANDARD
	AA = 0.0025 % (25 ppm) A = 0.005 % (50 ppm) B = 0.01 % (100 ppm) Standard	Blank = 0 °C to +70 °C R = -40 °C to +85 °C		

GLOBAL PART NUMBER

X	O	5	3	C	T	D	N	A	4	0	M
MODEL				FREQUENCY STABILITY	OTR	PACKAGE CODE	OPTIONS		FREQUENCY		

Full Size Clock Oscillators TTL/HCMOS Compatible



FEATURES

- 14 pin full size
- Industry standard
- Wide frequency range
- Low cost
- Tri-State enable/disable
- Resistance weld package
- 5 V
- Lead (Pb)-free terminations and RoHS compliant



The XO-54 series oscillator is Full Size Tri-state Enable/Disable control. The metal package with pin #7 case ground acts as shielding to minimize EMI radiation.

STANDARD ELECTRICAL SPECIFICATIONS			
PARAMETER	SYMBOL	CONDITION	XO-54
Frequency Range	F _O		1 MHz ~ 100.00 MHz
Frequency Stability*		All Condition*	±25 ppm, ±50 ppm, ±100 ppm
Operating Temperature Range	T _{OPR}		0 °C ~ 70 °C (-40 °C ~ +85 °C option)
Storage Temperature Range	T _{STG}		-55 °C ~ +125 °C
Power Supply Voltage	V _{DD}		5.0 V ± 10 %
Aging (First Year)		25 °C ± 3 °C	±5 ppm
Supply Current	I _{DD}	1 MHz to 23.999 MHz	20 mA Max
		24.000 MHz to 49.999 MHz	30 mA Max
		50.000 MHz to 69.999 MHz	40 mA Max
		70.000 MHz to 100.000 MHz	60 mA Max
Output Symmetry	Sym	1/2 V _{DD}	40/60 % (45/55 % Option)
Rise Time	T _r	10 % V _{DD} ~ 90 % V _{DD}	10 nS Max
Fall Time	T _f	90 % V _{DD} ~ 10 % V _{DD}	10 nS Max
Output Voltage	V _{OH}		90 % V _{DD} Min
	V _{OL}		10 % V _{DD} Max
Output Load	TTL Load		1 ~ 10 TTL
	HCMOS Load		~50 M : 50 pF
			~70 M : 30 pF
Start-up Time		T _s	~100 M : 15 pF 10 mS Max
Pin 1, Tri-State Function			Pin 1 = H or open.... Output active at pin 8 Pin 1 = L.... High Impedance at pin 8

*Include: 25 °C tolerance, operating temperature range, input voltage change, aging, load change, shock and vibration.

DIMENSIONS in millimeters

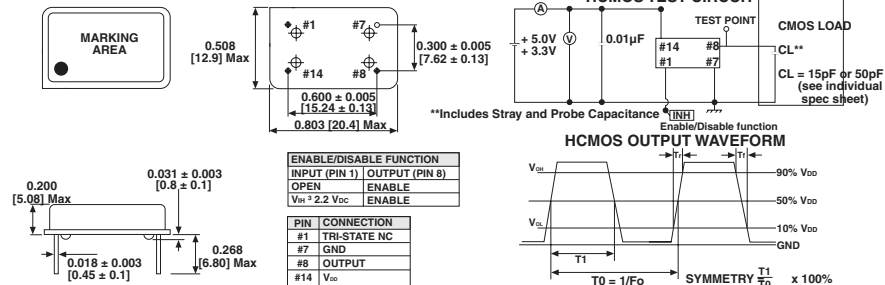

ORDERING INFORMATION					
XO-54	B	R	E	40 M	e2
MODEL	FREQUENCY STABILITY	OTR	ENABLE/DISABLE	FREQUENCY/MHz	JEDEC Lead (Pb)-Free STANDARD
	AA = 0.0025 % (25 ppm) A = 0.005 % (50 ppm) B = 0.01 % (100 ppm) Standard	Blank = 0 °C to +70 °C R = -40 °C to +85 °C	Blank = Pin 1 open E = Disable or Tristate		

GLOBAL PART NUMBER												
X	O	5	4	C	T	E	D	N	A	4	0	M
MODEL				FREQUENCY STABILITY		OTR	ENABLE/DISABLE CODE	OPTIONS		FREQUENCY		

Full Size Clock Oscillators TTL/HCMOS Compatible



FEATURES

- 14 pin full size
- Industry standard
- Wide frequency range
- Low cost
- Tri-State enable/disable
- Resistance weld package
- 3.3 V
- Lead (Pb)-free terminations and RoHS compliant



The XO-543 series is with 3.3 V power supply. The metal package with pin #7 case ground acts as shielding to minimize EMI radiation.

STANDARD ELECTRICAL SPECIFICATIONS			
PARAMETER	SYMBOL	CONDITION	XO-543
Frequency Range	F_O		1 MHz ~ 100.00 MHz
Frequency Stability*		All Condition*	± 25 ppm, ± 50 ppm, ± 100 ppm
Operating Temperature Range	T_{OPR}		0 °C ~ 70 °C (-40 °C ~ +85 °C option)
Storage Temperature Range	T_{STG}		-55 °C ~ +125 °C
Power Supply Voltage	V_{DD}		3.3 V \pm 10 %
Aging (first year)		25 °C \pm 3 °C	± 5 ppm
Supply Current	I_{DD}	1 MHz TO 23.999 MHz	15 mA Max
		24.000 MHz TO 49.999 MHz	20 mA Max
		50.000 MHz TO 69.999 MHz	30 mA Max
		70.000 MHz TO 100.000 MHz	45 mA Max
Output Symmetry	Sym	$1/2 V_{DD}$	40/60 % (45/55 % option)
Rise Time	T_r	10 % V_{DD} ~ 90 % V_{DD}	8 nS Max
Fall Time	T_f	90 % V_{DD} ~ 10 % V_{DD}	8 nS Max
Output Voltage	V_{OH}		90 % V_{DD} Min
	V_{OL}		10 % V_{DD} Max
Output Load	TTL Load		1 ~ 5 TTL
	HCMOS load		~ 50 M : 30 pF ~ 125 M : 15 pF
Start-up Time		T_s	10 mS Max
Pin 1, Tri-State Function			Pin 1 = H or open.... Output active at pin 8 Pin 1 = L.... High Impedance at pin 8

*Include: 25 °C tolerance, operating temperature range, input voltage change, aging, load change, shock and vibration.

DIMENSIONS in millimeters

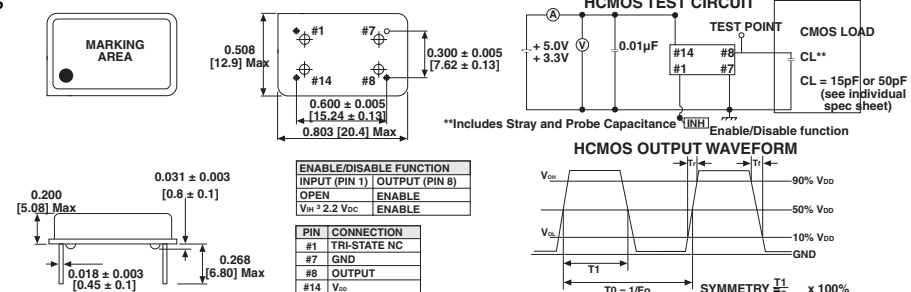

ORDERING INFORMATION

XO-543 MODEL	B FREQUENCY STABILITY	R OTR	E ENABLE/DISABLE	40 M FREQUENCY/MHz	e2 JEDEC Lead (Pb)-Free STANDARD
AA = 0.0025 % (25 ppm)	Blank = 0 °C to +70 °C	Blank = Pin 1 open	Blank = 0 °C to +70 °C		
A = 0.005 % (50 ppm)	R = -40 °C to +85 °C	E = Disable or Tristate			
B = 0.01 % (100 ppm)					

GLOBAL PART NUMBER

X	O	3	4	C	T	E	D	N	A	4	0	M
MODEL				FREQUENCY STABILITY		OTR	ENABLE/DISABLE CODE	OPTIONS		FREQUENCY		

Half Size Clock Oscillators Enable/Disable



FEATURES

- Tri-state enable/disable
- 8 pin half size
- Industry standard
- Wide frequency range
- Low cost
- Resistance weld package
- 5 V
- Lead (Pb)-free terminations and RoHS compliant



The XO-52 series oscillator is half size, has Tri-state enable/disable controlled function. The metal package with pin#4 case ground acts as shielding to minimize EMI radiation.

STANDARD ELECTRICAL SPECIFICATIONS			
PARAMETER	SYMBOL	CONDITION	XO-52
Frequency Range	F_O		1 MHz ~ 100.00 MHz
Frequency Stability*		All Condition*	± 25 ppm, ± 50 ppm, ± 100 ppm
Operating Temperature Range	T_{OPR}		0 °C ~ 70 °C (-40 °C ~ +85 °C option)
Storage Temperature Range	T_{STG}		-55 °C ~ +125 °C
Power Supply Voltage	V_{DD}		5.0 V \pm 10 %
Aging (First Year)		25 °C \pm 3 °C	± 5 ppm
Supply Current	I_{DD}	1 MHz to 23.999 MHz	20 mA Max
		24.000 MHz to 49.999 MHz	30 mA Max
		50.000 MHz to 69.999 MHz	40 mA Max
		70.000 MHz to 100.000 MHz	60 mA Max
Output Symmetry	Sym	At 1/2 V_{DD}	40/60 % (45/55 % Option)
Rise Time	T_r	20 % V_{DD} ~ 80 % V_{DD}	10 nS Max
Fall Time	T_f	80 % V_{DD} ~ 20 % V_{DD}	10 nS Max
Output Voltage	V_{OH}		90 % V_{DD} Min
	V_{OL}		10 % V_{DD} Max
Output Load	TTL Load		1 ~ 10 TTL
	HCMOS Load		~50 M : 50 pF ~70 M : 30 pF ~100 M : 15 pF
Start-up Time		T_s	10 mS Max
Pin 1, tri-state function			Pin 1 = H or open... Output active at pin 5 Pin 1 = L... high impedance at pin 5

*Include: 25 °C tolerance, operating temperature range, input voltage change, aging, load change, shock and vibration.

DIMENSIONS in inches [millimeters]

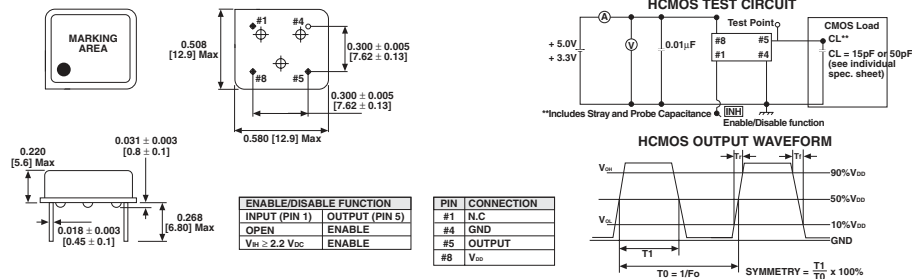

ORDERING INFORMATION					
XO-52	B	R	E	40 M	e2
MODEL	FREQUENCY STABILITY	OTR	ENABLE/DISABLE	FREQUENCY/MHZ	JEDEC Lead (Pb)-Free STANDARD
	AA = 0.0025 % (25 ppm)	Blank = 0 °C to +70 °C	Blank = Pin 1 open		
	A = 0.005 % (50 ppm)	R = -40 °C to +85 °C	E = - Disable to Tristate		
	B = 0.01 % (100 ppm) Standard				

GLOBAL PART NUMBER												
X	O	5	2	C	T	E	L	N	A	4	0	M
MODEL				FREQUENCY STABILITY		OTR	ENABLE/DISABLE	PACKAGE CODE	OPTIONS		FREQUENCY	

Half Size Clock Oscillators Enable/Disable



The XO-523 series oscillator is half size, has Tri-state enable/disable controlled function, and is with a 3.3 V power supply voltage. The metal package with pin#4 case ground acts as shielding to minimize EMI radiation.

FEATURES

- Tri-state enable/disable
- 8 pin half size
- Industry standard
- Wide frequency range
- Low cost
- Resistance weld package
- 3.3 V
- Lead (Pb)-free terminations and RoHS compliant



STANDARD ELECTRICAL SPECIFICATIONS			
PARAMETER	SYMBOL	CONDITION	XO-523
Frequency Range	F_O		1 MHz ~ 100.00 MHz
Frequency Stability*		All Condition*	± 25 ppm, ± 50 ppm, ± 100 ppm
Operating Temperature Range	T_{OPR}		0 °C ~ 70 °C (-40 °C ~ +85 °C option)
Storage Temperature Range	T_{STG}		-55 °C ~ +125 °C
Power Supply Voltage	V_{DD}		3.3 V \pm 10 %
Aging (First Year)		25 °C \pm 3 °C	± 5 ppm
Supply Current	I_{DD}	1 MHz to 23.999 MHz	15 mA Max
		24.000 MHz to 49.999 MHz	20 mA Max
		50.000 MHz to 69.999 MHz	30 mA Max
		70.000 MHz to 100.000 MHz	45 mA Max
Output Symmetry	Sym	At 1/2 V_{DD}	40/60 % (45/55 % Option)
Rise Time	T_r	20 % V_{DD} ~ 80 % V_{DD}	8 nS Max
Fall Time	T_f	80 % V_{DD} ~ 20 % V_{DD}	8 nS Max
Output Voltage	V_{OH}		90 % V_{DD} Min
	V_{OL}		10 % V_{DD} Max
Output Load	TTL Load		1 ~ 5 TTL
	HCMOS Load		~50 M : 30 pF ~125 M : 15 pF
Start-up Time		T_s	10 mS Max
Pin 1, tri-state function			Pin 1 = H or open... Output active at pin 5 Pin 1 = L... high impedance at pin 5

*Include: 25 °C tolerance, operating temperature range, input voltage change, aging, load change, shock and vibration.

DIMENSIONS in inches [millimeters]

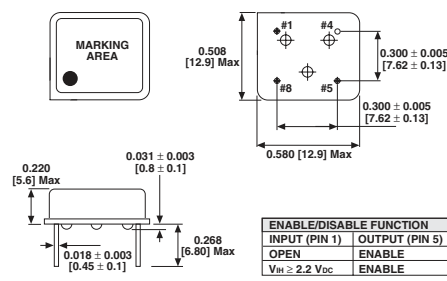

ENABLE/DISABLE FUNCTION	
INPUT (PIN 1)	OUTPUT (PIN 5)
OPEN	ENABLE
$V_{IN} \geq 2.2 V_{CC}$	ENABLE

PIN CONNECTION	
#1	N.C
#4	GND
#5	OUTPUT
#8	V_{DD}

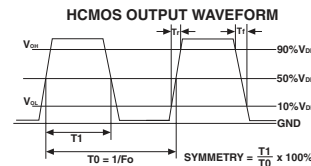
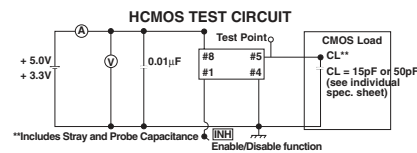

ORDERING INFORMATION

XO-523 MODEL	B FREQUENCY STABILITY	R OTR	E ENABLE/DISABLE	40 M FREQUENCY/MHz	e2 JEDEC Lead (Pb)-Free STANDARD
	AA = 0.0025 % (25 ppm) A = 0.005 % (50 ppm) B = 0.01 % (100 ppm)	Blank = 0 °C to +70 °C R = -40 °C to +85 °C	Blank = Pin 1 open E = - Disable to Tristate		

GLOBAL PART NUMBER

X	O	3	2	C	T	E	L	N	A	4	0	M
MODEL				FREQUENCY STABILITY	OTR	ENABLE/DISABLE	PACKAGE CODE	OPTIONS		FREQUENCY		

Full Size Clock Oscillators TTL/HCMOS Compatible



The XO-56 series oscillator is Full Size for low frequency. The metal package with pin #7 case ground acts as shielding to minimize EMI radiation.

FEATURES

- 14 pin full size
- Industry standard
- Low frequency range
- Low cost
- Resistance weld package
- 5 V
- Lead (Pb)-free terminations and RoHS compliant



STANDARD ELECTRICAL SPECIFICATIONS			
PARAMETER	SYMBOL	CONDITION	XO-56
Frequency Range	F_O		1.0 kHz ~ 999.9 kHz
Frequency Stability*		All Condition*	± 25 ppm, ± 50 ppm, ± 100 ppm
Operating Temperature Range	T_{OPR}		0 °C ~ 70 °C (-40 °C ~ +85 °C option)
Storage Temperature Range	T_{STG}		-55 °C ~ +125 °C
Power Supply Voltage	V_{DD}		5.0 V \pm 10 %
Aging (First Year)		25 °C \pm 3 °C	\pm 5 ppm
Supply Current	I_{DD}	1.0 kHz to 999.9 kHz	10 mA Max
Output Symmetry	Sym	$1/2 V_{DD}$	40/60 % (45/55 % Option)
Rise Time	T_r	10 % V_{DD} ~ 90 % V_{DD}	10 nS Max
Fall Time	T_f	90 % V_{DD} ~ 10 % V_{DD}	10 nS Max
Output Voltage	V_{OH}		90 % V_{DD} Min
	V_{OL}		10 % V_{DD} Max
Output Load	TTL Load		1 ~ 10 TTL
	HCMOS Load		15 pF
Start-up Time		T_s	10 mS Max

*Include: 25 °C tolerance, operating temperature range, input voltage change, aging, load change, shock and vibration.

DIMENSIONS in millimeters

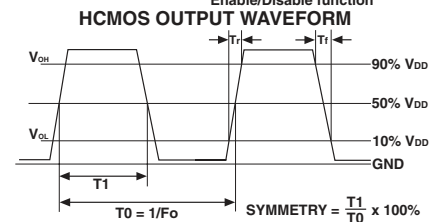
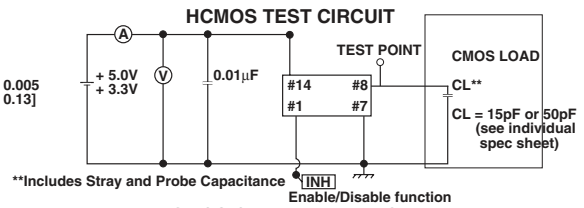
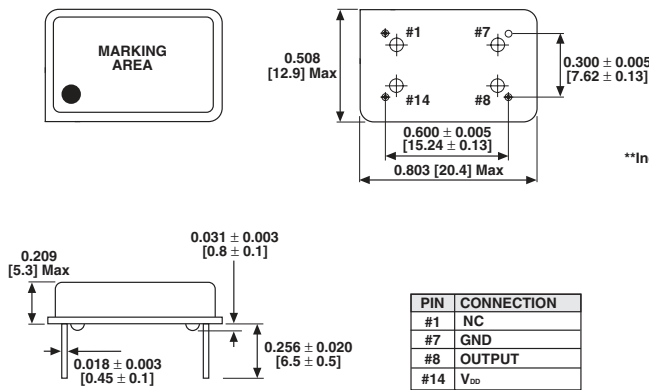

ORDERING INFORMATION				
XO-56 MODEL	B FREQUENCY STABILITY AA = 0.0025 % (25 ppm) A = 0.005 % (50 ppm) B = 0.01 % (100 ppm) Standard	R OTR Blank = 0 °C to +70 °C R = -40 °C to +85 °C	256 K FREQUENCY/kHz	e2 JEDEC Lead (Pb)-Free STANDARD

GLOBAL PART NUMBER												
X	O	5	6	C	T	D	N	A	2	5	6	K
MODEL				FREQUENCY STABILITY	OTR	PACKAGE CODE	OPTIONS		FREQUENCY			



Full Size Voltage Controlled Crystal Oscillators



The XOVC-23 is a full size voltage controlled crystal oscillator designed primarily for use in phase locked loops, phase shift keying and other tele-communication applications such as ADSL and cable modem.

FEATURES

- 14 pin half size
- Industry standard
- Wide frequency range
- Low cost
- Resistance weld package
- Lead (Pb)-free terminations and RoHS compliant



RoHS
COMPLIANT

STANDARD ELECTRICAL SPECIFICATIONS

PARAMETER	SYMBOL	CONDITION	XOVC-23
Frequency Range*	F _O		1 MHz ~ 40.00 MHz
Frequency Calibration		At 25 °C	±15 ppm
Temperature Stability		Over T _{OPR}	±15 ppm, ±25 ppm, ±50 ppm
Stability vs. power change		V _{DD} ± 5 %	±5 ppm
Stability vs. load change		15 pF ± 10 %	±3 ppm
Pullability		Over Control Voltage Range	±50 ppm, ±100 ppm, ± 200 ppm
Control Voltage Range			0.5 ~ 4.5 V
Operating Temperature Range	T _{OPR}		0 °C ~ 70 °C (-40 °C ~ +85 °C option)
Storage Temperature Range	T _{STG}		-55 °C ~ +125 °C
Power Supply Voltage	V _{DD}		5.0 V ± 5 %
Aging (First Year)		25 °C ± 3 °C	±5 ppm
Supply Current	I _{DD}	1.000 MHz to 23.999 MHz	15 mA Max
		24.000 MHz to 40.000 MHz	25 mA Max
Output Symmetry	Sym	At 1/2 V _{DD}	40/60 % (45/55 % Option)
Rise Time	T _r	20 % V _{DD} ~ 80 % V _{DD}	10 nS Max
Fall Time	T _f	80 % V _{DD} ~ 20 % V _{DD}	10 nS Max
Output Voltage	V _{OH}		90 % V _{DD} Min
	V _{OL}		10 % V _{DD} Max
Output Load			15 pF Max
Start-up Time		T _s	10 mS Max

*Frequency over 40.000 MHz, please consult factory

DIMENSIONS in inches [millimeters]

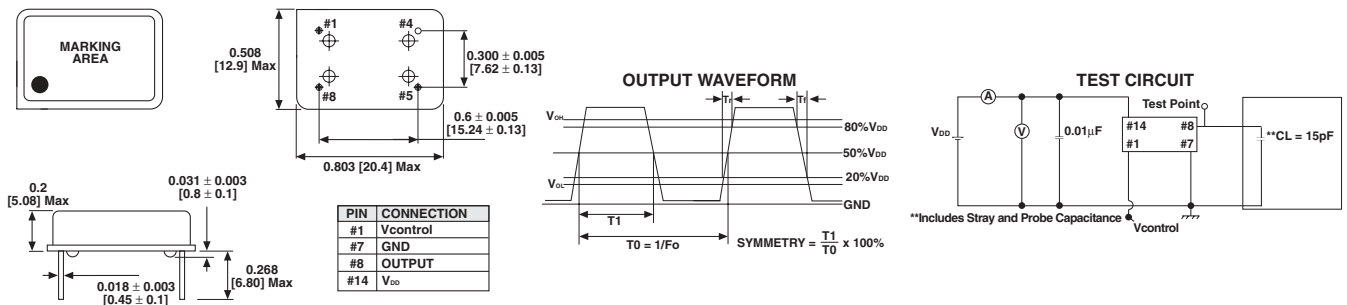

ORDERING INFORMATION

XOVC-23 MODEL	B FREQUENCY STABILITY	-1 PULLABILITY	27 M FREQUENCY/MHz	e2 JEDEC Lead (Pb)-Free STANDARD
	AA = 0.0025 % (25 ppm) A = 0.005 % (50 ppm) B = 0.01 % (100 ppm)	-1 = ±100 ppm -2 = ±200 ppm -3 = ±50 ppm		

Note: Contact factory for other models, frequencies, stabilities and temperature ranges.

GLOBAL PART NUMBER

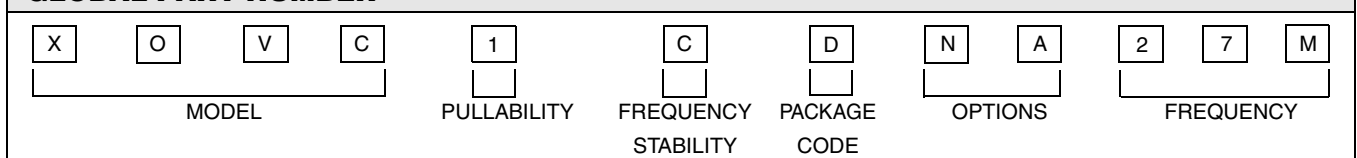

Half Size Clock Oscillator Enable/Disable



FEATURES

- Tri-state enable/disable
- 8 pin half size
- Industry standard
- Wide frequency range
- Low cost
- Resistance weld package
- 5 V
- Lead (Pb)-free and RoHS compliant



The XOSM-52 series oscillator is half size, has Tri-state enable/disable controlled function. The metal package with pin#4 case ground acts as shielding to minimize EMI radiation.

STANDARD ELECTRICAL SPECIFICATIONS			
PARAMETER	SYMBOL	CONDITION	XOSM-52
Frequency Range	F_O		1 MHz ~ 100.00 MHz
Frequency Stability*		All Condition*	± 25 ppm, ± 50 ppm, ± 100 ppm
Operating Temperature Range	T_{OPR}		0 °C ~ 70 °C (-40 °C ~ +85 °C option)
Storage Temperature Range	T_{STG}		-55 °C ~ +125 °C
Power Supply Voltage	V_{DD}		5.0 V \pm 10 %
Aging (First Year)		25 °C \pm 3 °C	± 5 ppm
Supply Current	I_{DD}	1 MHz to 23.999 MHz	20 mA Max
		24.000 MHz to 49.999 MHz	30 mA Max
		50.000 MHz to 69.999 MHz	40 mA Max
		70.000 MHz to 100.000 MHz	60 mA Max
Output Symmetry	Sym	At $1/2 V_{DD}$	40/60 % (45/55 % Option)
Rise Time	T_r	20 % V_{DD} ~ 80 % V_{DD}	10 nS Max
Fall Time	T_f	80 % V_{DD} ~ 20 % V_{DD}	10 nS Max
Output Voltage	V_{OH}		90 % V_{DD} Min
	V_{OL}		10 % V_{DD} Max
Output Load	TTL Load		1 ~ 10 TTL
	HCMOS Load		~ 50 M : 50 pF
			~ 70 M : 30 pF
Start-up Time		T_s	10 mS Max
Pin 1, tri-state function			Pin 1 = H or open... Output active at pin 5 Pin 1 = L... high impedance at pin 5

*Include: 25 °C tolerance, operating temperature range, input voltage change, aging, load change, shock and vibration.

DIMENSIONS in inches [millimeters]

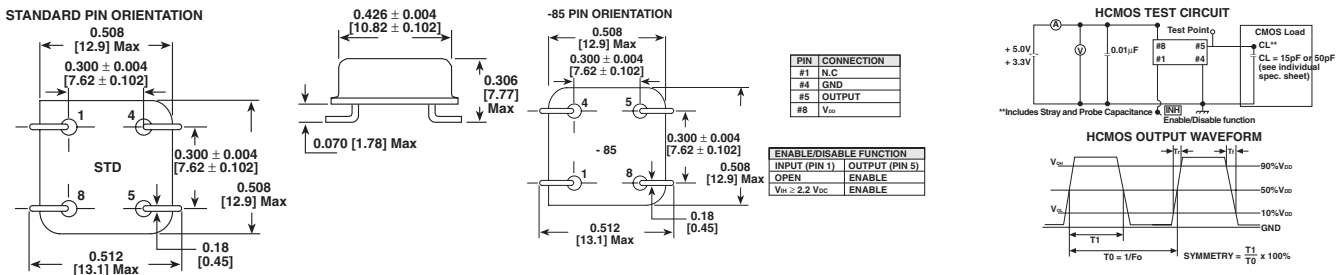

ORDERING INFORMATION					
XOSM-52 MODEL	B FREQUENCY STABILITY	R OTR	E ENABLE/DISABLE	40 M FREQUENCY/MHz	e2 JEDEC Lead (Pb)-Free STANDARD
	AA = 0.0025 % (25 ppm) A = 0.005 % (50 ppm) B = 0.01 % (100 ppm) Standard	Blank = 0 °C to 70 °C R = -40 °C to +85 °C	Blank = Pin 1 open E = - Disable to Tristate		

GLOBAL PART NUMBER												
X	O	5	M	C	T	E	L	N	A	4	0	M
MODEL				FREQUENCY STABILITY		OTR	ENABLE/DISABLE CODE	OPTIONS		FREQUENCY		

J - Lead Plastic Clock Oscillators



The XOSM-55 series oscillator is a J-Lead plastic tri-state enable/disable controlled clock oscillator with a 5.0 V power supply voltage. The J-Lead configuration and high resistance soldering temperature make it ideal for surface mount production.

FEATURES

- J-Lead plastic surface mount
- SG-615 compatible
- Wide frequency range
- Low cost
- Tri-state enable/disable
- 5.0 V power supply
- Lead (Pb)-free terminations and RoHS compliant



RoHS
COMPLIANT

STANDARD ELECTRICAL SPECIFICATIONS			
PARAMETER	SYMBOL	CONDITION	XOSM-55
Frequency Range	F_O		1 MHz ~ 66.667 MHz
Frequency Stability*			± 50 ppm, ± 100 ppm
Operating Temperature	T_{OPR}		0 °C ~ 70 °C (-40 °C ~ +85 °C option)
Storage Temperature Range	T_{STG}		-55 °C ~ +125 °C
Power Supply Voltage	V_{DD}		5.0 V \pm 1 0%
Aging (First Year)		25 °C \pm 3 °C	± 5 ppm
Supply Current	I_{DD}	1.000 MHz to 23.999 MHz	20 mA Max
		24.000 MHz to 49.999 MHz	30 mA Max
		50.000 MHz to 66.667 MHz	40 mA Max
Output Symmetry	Sym	At 0.5 V_{DD}	40/60 % (45/55 % Option)
Rise Time	T_r	10 % V_{DD} ~ 90 % V_{DD}	8 nS Max
Fall Time	T_f	90 % V_{DD} ~ 10 % V_{DD}	7 nS Max
Output Voltage	V_{OH}		90 % V_{DD} Min
	V_{OL}		10 % V_{DD} Max
Output Load	TTL Load		1 ~ 10 LSTTL
	HCMOS Load		30 pF Max
Start-up Time		T_s	10 mS Max
Pin 1, tri-state function			Pin 1 = H or open.... output active at pin 3 Pin 1 = L..... high impedance at pin 3

*Include: 25 °C tolerance, operating temperature range, input voltage change, aging, load change, shock and vibration.

DIMENSIONS in inches [millimeters]

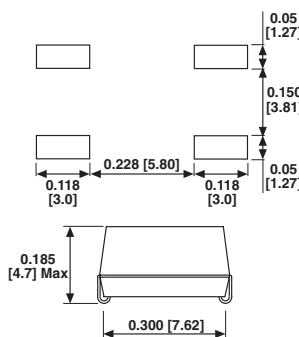
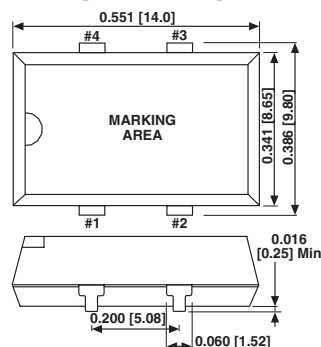

PIN	CONNECTION
#1	TRI-STATE/NC
#2	GND
#3	OUTPUT
#4	V_{DD}

ENABLE/DISABLE FUNCTION	
INPUT(PIN1)	OUTPUT(PIN3)
OPEN	ENABLE
$V_{IH} \geq 2.2V_{DD}$	ENABLE
$V_{IL} \leq 0.8V_{DD}$	DISABLE

***note: A 0.01uF bypass capacitor should be placed between V_{DD} (Pin4) and GND(Pin2) to minimize power supply line noise

ORDERING INFORMATION					
XOSM-55 MODEL	B FREQUENCY STABILITY	R OTR	E ENABLE/DISABLE	50 M FREQUENCY/MHz	e2 JEDEC Lead (Pb)-Free STANDARD
	A = 0.005 % (50 ppm) B = 0.01 % (100 ppm) Standard	Blank = Standard R = -40 °C to +85 °C	E = Disable to Tristate		

GLOBAL PART NUMBER												
X	O	5	5	C	T	E	D	N	A	5	0	M
MODEL				FREQUENCY STABILITY		OTR	ENABLE/DISABLE CODE	OPTIONS		FREQUENCY		

Surface Mount Oscillator



The XOSM-553 series oscillator is a J-Lead plastic tri-state enable/disable controlled clock oscillator with a 3.3 V power supply voltage. The J-Lead configuration and high resistance soldering temperature make it ideal for surface mount production.

FEATURES

- J-Lead plastic surface mount
- SG-615 compatible
- Wide frequency range
- Low cost
- Tri-state enable/disable
- 3.3 V power supply
- Lead (Pb)-free terminations and RoHS compliant



STANDARD ELECTRICAL SPECIFICATIONS			
PARAMETER	SYMBOL	CONDITION	XOSM-553
Frequency Range	F_O		1 MHz ~ 66.667 MHz
Frequency Stability*			± 50 ppm, ± 100 ppm
Operating Temperature	T_{OPR}		0 °C ~ 70 °C (-40 °C ~ +85 °C option)
Storage Temperature Range	T_{STG}		-55 °C ~ +125 °C
Power Supply Voltage	V_{DD}		3.3 V \pm 10 %
Aging (First Year)		25 °C \pm 3 °C	± 5 ppm
Supply Current	I_{DD}	1.000 MHz to 23.999 MHz	15 mA Max
		24.000 MHz to 49.999 MHz	20 mA Max
		50.000 MHz to 66.667 MHz	30 mA Max
Output Symmetry	Sym	At 1/2 V_{DD}	40/60 % (45/55 % Option)
Rise Time	T_r	10 % V_{DD} ~ 90 % V_{DD}	5 nS Max
Fall Time	T_f	90 % V_{DD} ~ 10 % V_{DD}	5 nS Max
Output Voltage	V_{OH}		90 % V_{DD} Min
	V_{OL}		10 % V_{DD} Max
Output Load	TTL Load		1 ~ 10 LSTTL
	HCMOS Load		15 pF Max
Start-up Time		T_s	10 mS Max
Pin 1, tri-state function			Pin 1 = H or open.... output active at pin 3 Pin 1 = L..... high impedance at pin 3

*Include: 25 °C tolerance, operating temperature range, input voltage change, aging, load change, shock and vibration.

DIMENSIONS in inches [millimeters]

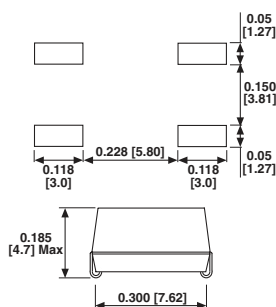
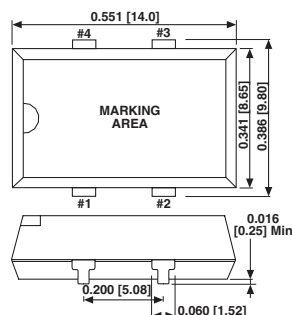

PIN	CONNECTION
#1	TRI-STATE/NC
#2	GND
#3	OUTPUT
#4	V_{DD}

ENABLE/DISABLE FUNCTION	
INPUT(PIN1)	OUTPUT(PIN3)
OPEN	ENABLE
$V_{IH} \geq 2.2V_{oc}$	ENABLE
$V_{IL} \leq 0.8V_{oc}$	DISABLE

***note: A 0.01 μ F bypass capacitor should be placed between V_{DD} (Pin4) and GND(Pin2) to minimize power supply line noise

ORDERING INFORMATION					
XOSM-53 MODEL	B FREQUENCY STABILITY A = 0.005 % (50 ppm) B = 0.01 % (100 ppm) Standard	R OTR Blank = Standard R = -40 °C to +85 °C	E ENABLE/DISABLE E = Disable to Tristate	50 M FREQUENCY/MHz	e2 JEDEC Lead (Pb)-Free STANDARD

GLOBAL PART NUMBER												
X	O	3	5	C	T	E	D	N	A	5	0	M
MODEL				FREQUENCY STABILITY	OTR	ENABLE/DISABLE	PACKAGE CODE	OPTIONS		FREQUENCY		



Surface Mount Oscillator



The XOSM-57 series is an ultra miniature package clock oscillator with dimensions 7.0 x 5.0 x 1.6 mm. It is mainly used in portable PC and telecommunication devices and equipment.

FEATURES

- Miniature Package
- Tri-state enable/disable
- TTL/HCMOS compatible
- Tape and Reel
- IR Re-flow
- 5 V input voltage
- 100 % Lead (Pb)-free and RoHS compliant



RoHS
COMPLIANT

STANDARD ELECTRICAL SPECIFICATIONS			
PARAMETER	SYMBOL	CONDITION	XOSM-57
Frequency Range	F_O		1 MHz ~ 100.000 MHz
Frequency Stability*		All Condition*	± 25 ppm, ± 50 ppm, ± 100 ppm
Operating Temperature	T_{OPR}		0 °C ~ 70 °C (-40 °C ~ +85 °C option)
Storage Temperature Range	T_{STG}		-55 °C ~ +125 °C
Power Supply Voltage	V_{DD}		5.0 V \pm 10 %
Aging (First Year)		25 °C \pm 3 °C	± 5 ppm
Supply Current	I_{DD}	1.000 MHz to 23.999 MHz	20 mA Max
		24.000 MHz to 49.999 MHz	30 mA Max
		50.000 MHz to 69.999 MHz	40 mA Max
		70.000 MHz to 100.000 MHz	60 mA Max
Output Symmetry	Sym	At $\frac{1}{2} V_{DD}$	40/60 % (45/55 % Option)
Rise Time	T_r	10 % V_{DD} ~ 90 % V_{DD}	5 nS Max
Fall Time	T_f	90 % V_{DD} ~ 10 % V_{DD}	5 nS Max
Output Voltage	V_{OH}		90 % V_{DD} Min
	V_{OL}		10 % V_{DD} Max
Output Load	TTL Load		1 ~ 10 TTL
	HCMOS Load		30 pF Max
Start-up Time		T_s	10 mS Max
Pin 1, tri-state function			Pin 1 = H or open.... output active at pin 3 Pin 1 = L..... high impedance at pin 3

*Include: 25 °C tolerance, operating temperature range, input voltage change, aging, load change, shock and vibration.

DIMENSIONS in inches [millimeters]

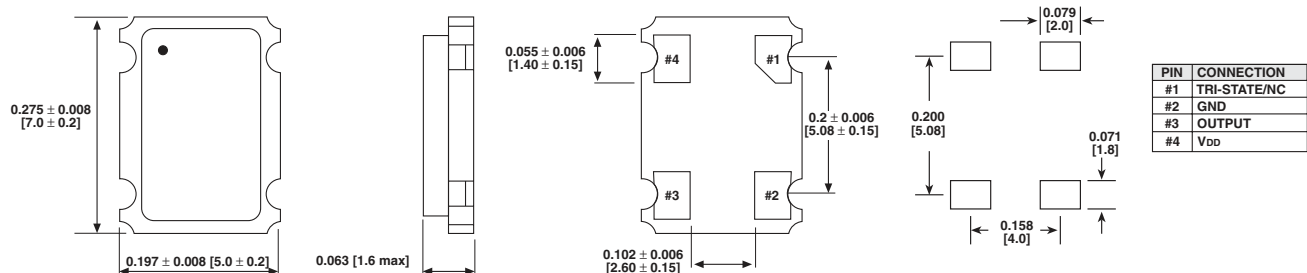

***note: A 0.01 μ F bypass capacitor should be placed between VDD(Pin4) and GND(Pin2) to minimize power supply line noise

ORDERING INFORMATION					
XOSM-57	B	R	E	50 M	e4
MODEL	FREQUENCY STABILITY	OTR	ENABLE/DISABLE	FREQUENCY/MHz	JEDEC Lead (Pb)-Free STANDARD
	AA = 0.0025 % (25 ppm) A = 0.005 % (50 ppm) B = 0.01 % (100 ppm) Standard	Blank = Standard R = -40 °C to +85 °C	E = Disable to Tristate		

GLOBAL PART NUMBER												
X	O	5	7	C	T	E	C	N	A	5	0	M
MODEL				FREQUENCY STABILITY		OTR	ENABLE/DISABLE	PACKAGE CODE	OPTIONS		FREQUENCY	

Surface Mount Oscillator



The XOSM-573 series is an ultra miniature package clock oscillator with dimensions 7.0 x 5.0 x 1.6 mm. It is mainly used in portable PC and telecommunication devices and equipment.

FEATURES

- Miniature Package
- Tri-state enable/disable
- TTL/HCMOS compatible
- Tape and Reel
- IR Re-flow
- 3.3 V input voltage
- 100 % Lead (Pb)-free and RoHS compliant



RoHS
COMPLIANT

STANDARD ELECTRICAL SPECIFICATIONS			
PARAMETER	SYMBOL	CONDITION	XOSM-573
Frequency Range	F _O		1 MHz ~ 100.000 MHz
Frequency Stability*		All Condition*	±25 ppm, ±50 ppm, ±100 ppm
Operating Temperature Range	T _{OPR}		0 °C ~ 70 °C (-40 °C ~ +85 °C option)
Storage Temperature Range	T _{STG}		-55 °C ~ +125 °C
Power Supply Voltage	V _{DD}		3.3 V ± 10 %
Aging (First Year)		25 °C ± 3 °C	±5 ppm
Supply Current	I _{DD}	1.000 MHz to 23.999 MHz	20 mA Max
		24.000 MHz to 49.999 MHz	30 mA Max
		50.000 MHz to 69.999 MHz	40 mA Max
		70.000 MHz to 100.000 MHz	60 mA Max
Output Symmetry	Sym	At 1/2 V _{DD}	40/60 % (45/55 % Option)
Rise Time	T _r	10 % V _{DD} ~ 90 % V _{DD}	5 nS Max
Fall Time	T _f	90 % V _{DD} ~ 10 % V _{DD}	5 nS Max
Output Voltage	V _{OH}		90 % V _{DD} Min
	V _{OL}		10 % V _{DD} Max
Output Load	HCMOS Load		30 pF Max
Start-up Time		T _s	10 mS Max
Pin 1, tri-state function			Pin 1 = H or open.... output active at pin 3 Pin 1 = L..... high impedance at pin 3

*Include: 25 °C tolerance, operating temperature range, input voltage change, aging, load change, shock and vibration.

DIMENSIONS in inches [millimeters]

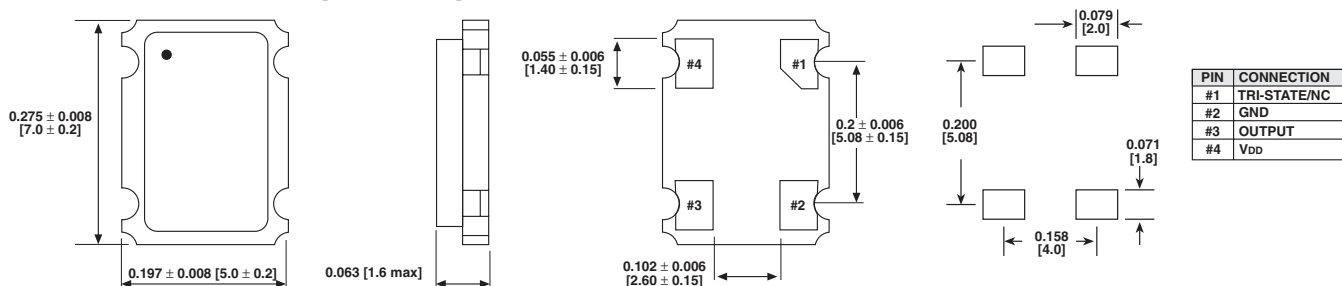

***note: A 0.01 µF bypass capacitor should be placed between VDD(Pin4) and GND(Pin2) to minimize power supply line noise

ORDERING INFORMATION					
XOSM-573	B	R	E	50 M	e4
MODEL	FREQUENCY STABILITY	OTR	ENABLE/DISABLE	FREQUENCY/MHz	JEDEC Lead (Pb)-Free STANDARD
	AA = 0.0025 % (25 ppm) A = 0.005 % (50 ppm) B = 0.01 % (100 ppm) Standard	Blank = Standard R = -40 °C to +85 °C	E = Disable to Tristate		

GLOBAL PART NUMBER												
X	O	3	7	C	T	E	C	N	A	5	0	M
MODEL				FREQUENCY STABILITY	OTR	ENABLE/DISABLE	PACKAGE CODE	OPTIONS		FREQUENCY		

Surface Mount Oscillator



The XOSM-572 series is an ultra miniature package clock oscillator with dimensions 7.0 x 5.0 x 1.5 mm. It is mainly used in portable PC and telecommunication devices and equipment.

FEATURES

- Miniature Package
- Tri-state enable/disable
- HCMOS compatible
- Tape and Reel
- IR Re-flow
- 2.5 V input voltage
- 100 % Lead (Pb)-free and RoHS compliant

RoHS
COMPLIANT

STANDARD ELECTRICAL SPECIFICATIONS			
PARAMETER	SYMBOL	CONDITION	XOSM-572
Frequency Range	F_O		1 MHz ~ 100.000 MHz
Frequency Stability*		All Condition*	± 25 ppm, ± 50 ppm, ± 100 ppm
Operating Temperature	T_{OPR}		0 °C ~ 70 °C (-40 °C ~ +85 °C option)
Storage Temperature Range	T_{STG}		-55 °C ~ +125 °C
Power Supply Voltage	V_{DD}		2.5 V \pm 10 %
Aging (First Year)		25 °C \pm 3 °C	± 5 ppm
Supply Current	I_{DD}	1.000 MHz to 23.999 MHz	12 mA Max
		24.000 MHz to 49.999 MHz	15 mA Max
		50.000 MHz to 69.999 MHz	20 mA Max
		70.000 MHz to 100.000 MHz	30 mA Max
Output Symmetry	Sym	At $1/2 V_{DD}$	40/60 % (45/55 % Option)
Rise Time	T_r	10 % V_{DD} ~ 90 % V_{DD}	7 nS Max
Fall Time	T_f	90 % V_{DD} ~ 10 % V_{DD}	7 nS Max
Output Voltage	V_{OH}		90 % V_{DD} Min
	V_{OL}		10 % V_{DD} Max
Output Load	HCMOS Load		30 pF Max
Start-up Time		T_s	10 mS Max
Pin 1, tri-state function			Pin 1 = H or open.... output active at pin 3 Pin 1 = L.... high impedance at pin 3

*Include: 25 °C tolerance, operating temperature range, input voltage change, aging, load change, shock and vibration.

DIMENSIONS in inches [millimeters]

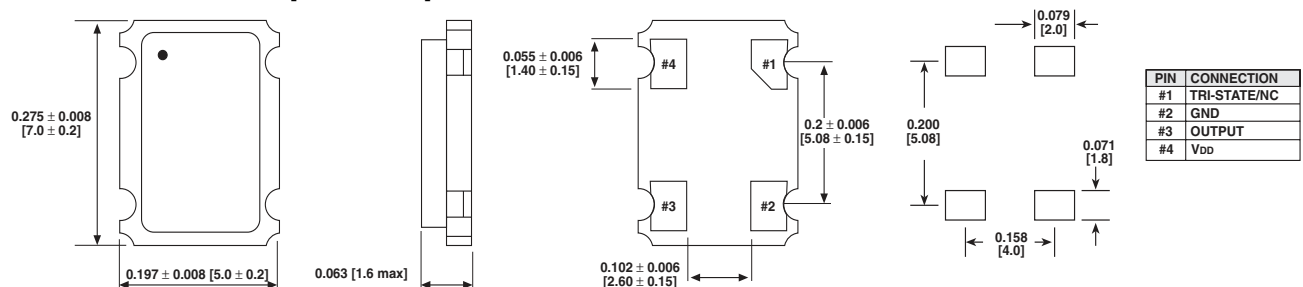

***note: A 0.01 μ F bypass capacitor should be placed between V_{DD} (Pin4) and GND(Pin2) to minimize power supply line noise

ORDERING INFORMATION

XOSM-572	B	R	E	50 M	e4
MODEL	FREQUENCY STABILITY	OTR	ENABLE/DISABLE	FREQUENCY/MHz	JEDEC Lead (Pb)-Free STANDARD
	AA = 0.0025 % (25 ppm) A = 0.005 % (50 ppm) B = 0.01 % (100 ppm) Standard	Blank = Standard R = -40 °C to +85 °C	E = Disable to Tristate		

GLOBAL PART NUMBER

X	O	2	7	C	T	E	C	N	A	5	0	M
MODEL				FREQUENCY STABILITY		OTR	ENABLE/DISABLE CODE	OPTIONS		FREQUENCY		

Surface Mount Oscillator



The XOSM-571 series is an ultra miniature package clock oscillator with dimensions 7.0 x 5.0 x 1.5 mm. It is mainly used in portable PC and telecommunication devices and equipment.

FEATURES

- Miniature Package
- Tri-state enable/disable
- HCMOS compatible
- Tape and Reel
- IR Re-flow
- 1.8 V input voltage
- 100 % Lead (Pb)-free and RoHS compliant



RoHS COMPLIANT

STANDARD ELECTRICAL SPECIFICATIONS			
PARAMETER	SYMBOL	CONDITION	XOSM-571
Frequency Range	F _O		1 MHz ~ 100.000 MHz
Frequency Stability*		All Condition*	±25 ppm, ±50 ppm, ±100 ppm
Operating Temperature	T _{OPR}		0 °C ~ 70 °C (-40 °C ~ +85 °C option)
Storage Temperature	T _{STG}		-55 °C ~ +125 °C
Power Supply Voltage	V _{DD}		1.8 V ± 10 %
Aging (First Year)		25 °C ± 3 °C	±5 ppm
Supply Current	I _{DD}	1.000 MHz to 23.999 MHz	10 mA Max
		24.000 MHz to 49.999 MHz	12 mA Max
		50.000 MHz to 69.999 MHz	15 mA Max
		70.000 MHz to 100.000 MHz	25 mA Max
Output Symmetry	Sym	At 1/2 V _{DD}	40/60 % (45/5 % Option)
Rise Time	T _r	10 % V _{DD} ~ 90 % V _{DD}	6 nS Max
Fall Time	T _f	90 % V _{DD} ~ 10 % V _{DD}	6 nS Max
Output Voltage	V _{OH}		90 % V _{DD} Min
	V _{OL}		10 % V _{DD} Max
Output Load	HCMOS Load		30 pF Max
Start-up Time		T _s	10 mS Max
Pin 1, tri-state function			Pin 1 = H or open.... output active at pin 3 Pin 1 = L..... high impedance at pin 3

*Include: 25 °C tolerance, operating temperature range, input voltage change, aging, load change, shock and vibration.

DIMENSIONS in inches [millimeters]

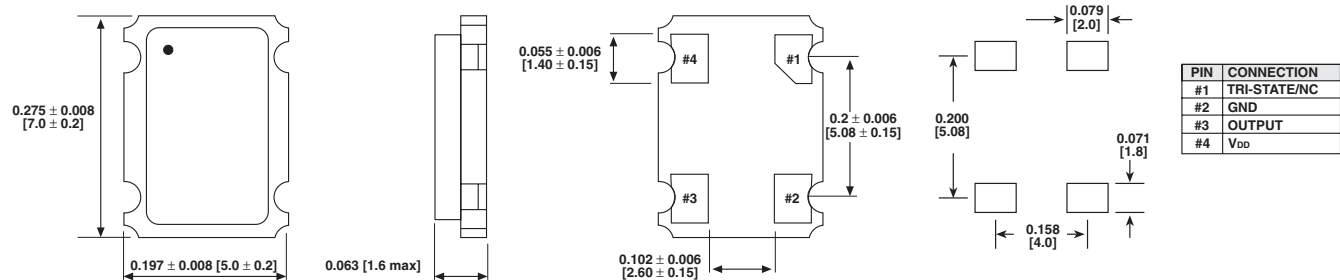

***note:A 0.01 μF bypass capacitor should be placed between VDD(Pin4) and GND(Pin2) to minimize power supply line noise

ORDERING INFORMATION					
XOSM-571	B	R	E	50 M	e4
MODEL	FREQUENCY STABILITY	OTR	ENABLE/DISABLE	FREQUENCY/MHz	JEDEC Lead (Pb)-Free STANDARD
	AA = 0.0025 % (25 ppm) A = 0.005 % (50 ppm) B = 0.01 % (100ppm) Standard	Blank = Standard R = -40 °C to +85 °C	E = Disable to Tristate		

GLOBAL PART NUMBER												
X	O	1	7	C	T	E	C	N	A	5	0	M
MODEL				FREQUENCY STABILITY		OTR	ENABLE/DISABLE CODE	PACKAGE OPTIONS		FREQUENCY		

Surface Mount Oscillator



The XOSM-533 series is an ultra miniature package clock oscillator with dimensions 5.0 x 3.2 x 1.3 mm. It is mainly used in portable PC and telecommunication devices and equipment.

FEATURES

- 5 x 3.2 x 1.3 Miniature Package
- Tri-state enable/disable
- HCMOS compatible
- Tape and Reel
- IR Re-flow
- 3.3 V input voltage
- Lead (Pb)-free terminations and RoHS compliant



STANDARD ELECTRICAL SPECIFICATIONS			
PARAMETER	SYMBOL	CONDITION	XOSM-533
Frequency Range	F _O		1.544 MHz ~ 100.000 MHz
Frequency Stability*		All Condition*	±25 ppm, ±50 ppm, ±100 ppm
Operating Temperature	T _{OPR}		0 °C ~ 70 °C (-40 °C ~ +85 °C option)
Storage Temperature Range	T _{STG}		-55 °C ~ +125 °C
Power Supply Voltage	V _{DD}		3.3 V ± 10 %
Aging (First Year)		25 °C ± 3 °C	±5 ppm
Supply Current	I _{DD}	1.544 MHz to 9.999 MHz	8 mA Max
		10.000 MHz to 34.999 MHz	10 mA Max
		35.000 MHz to 49.999 MHz	25 mA Max
		50.000 MHz to 100.000 MHz	35 mA Max
Output Symmetry	Sym	At 1/2 V _{DD}	40/60 % (45/55 % Option)
Rise Time	T _r	10 % V _{DD} ~ 90 % V _{DD}	7 nS Max
Fall Time	T _f	90 % V _{DD} ~ 10 % V _{DD}	7 nS Max
Output Voltage	V _{OH}		90 % V _{DD} Min
	V _{OL}		10 % V _{DD} Max
Output Load	HCMOS Load		30 pF Max (15 pF typ.)
Start-up Time		T _s	10 mS Max
Pin 1, tri-state function			Pin 1 = H or open.... output active at pin 3 Pin 1 = L..... high impedance at pin 3

*Include: 25 °C tolerance, operating temperature range, input voltage change, aging, load change, shock and vibration.

DIMENSIONS in inches [millimeters]

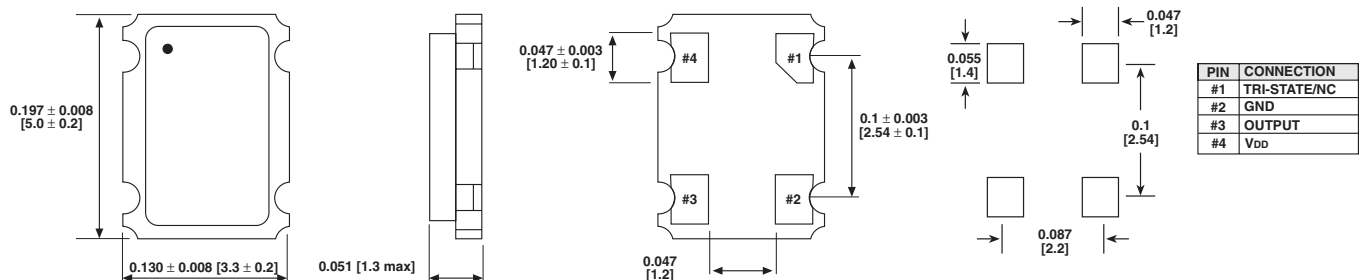

***note: A 0.01µF bypass capacitor should be placed between V_{DD}(Pin4) and GND(Pin2) to minimize power supply line noise

ORDERING INFORMATION							
XOSM-533	B	R	E	50 M	e2		
MODEL	FREQUENCY STABILITY	OTR	ENABLE/DISABLE	FREQUENCY/MHz	JEDEC Lead		
	AA = 0.0025 % (25 ppm) A = 0.005 % (50 ppm) B = 0.01 % (100 ppm) Standard	Blank = Standard R = -40 °C to +85 °C	E = Disable to Tristate		(Pb)-Free STANDARD		
GLOBAL PART NUMBER							
X	O	6	3	C	T	E	
						A	
						N	
						A	
						5	
						0	
						M	
MODEL		FREQUENCY STABILITY	OTR	ENABLE/DISABLE	PACKAGE CODES	OPTIONS	FREQUENCY

Surface Mount Oscillator



The XOSM-532 series is an ultra miniature package clock oscillator with dimensions 5.0 x 3.2 x 1.3 mm. It is mainly used in portable PC and telecommunication devices and equipment.

FEATURES

- 5 x 3.2 x 1.3 Miniature Package
- Tri-state enable/disable
- HCMOS compatible
- Tape and Reel
- IR Re-flow
- 2.5 V input voltage
- 100 % Lead (Pb)-free and RoHS compliant



RoHS
COMPLIANT

STANDARD ELECTRICAL SPECIFICATIONS			
PARAMETER	SYMBOL	CONDITION	XOSM-532
Frequency Range	F_O		1.544 MHz ~ 100.000 MHz
Frequency Stability*		All Condition*	± 25 ppm, ± 50 ppm, ± 100 ppm
Operating Temperature	T_{OPR}		0 °C ~ 70 °C (-40 °C ~ +85 °C option)
Storage Temperature Range	T_{STG}		-55 °C ~ +125 °C
Power Supply Voltage	V_{DD}		2.5 V \pm 10 %
Aging (First Year)		25 °C \pm 3 °C	± 5 ppm
Supply Current	I_{DD}	1.544 MHz to 9.999 MHz	7 mA Max
		10.000 MHz to 34.999 MHz	8 mA Max
		35.000 MHz to 49.999 MHz	20 mA Max
		50.000 MHz to 100.000 MHz	30 mA Max
Output Symmetry	Sym	At $1/2 V_{DD}$	40/60 % (45/55 % Option)
Rise Time	T_r	10 % V_{DD} ~ 90 % V_{DD}	6 nS Max
Fall Time	T_f	90 % V_{DD} ~ 10 % V_{DD}	6 nS Max
Output Voltage	V_{OH}		90 % V_{DD} Min
	V_{OL}		10 % V_{DD} Max
Output Load	HCMOS Load		30 pF Max (15 pF typ.)
Start-up Time		T_s	10 mS Max
Pin 1, tri-state function			Pin 1 = H or open.... output active at pin 3 Pin 1 = L..... high impedance at pin 3

*Include: 25 °C tolerance, operating temperature range, input voltage change, aging, load change, shock and vibration.

DIMENSIONS in inches [millimeters]

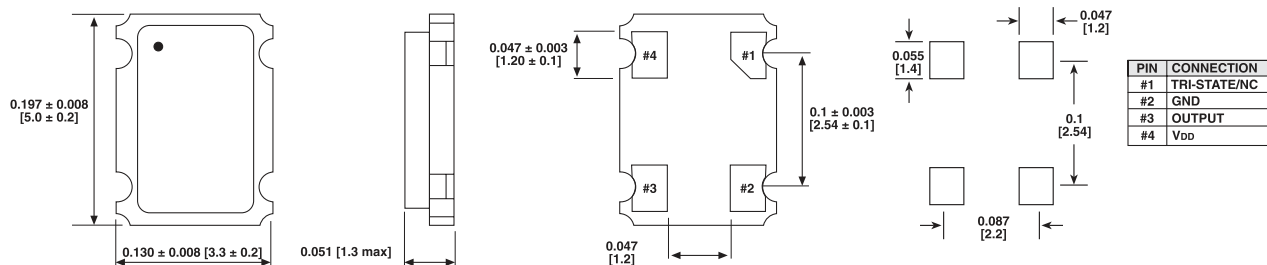

***note: A 0.01 μ F bypass capacitor should be placed between V_{DD} (Pin4) and GND(Pin2) to minimize power supply line noise

ORDERING INFORMATION					
XOSM-532	B	R	E	50 M	e4
MODEL	FREQUENCY STABILITY	OTR	ENABLE/DISABLE	FREQUENCY/MHz	JEDEC Lead (Pb)-Free STANDARD
	AA = 0.0025 % (25 ppm) A = 0.005 % (50 ppm) B = 0.01 % (100 ppm) Standard	Blank = Standard R = -40 °C to +85 °C	E = Disable to Tristate		

GLOBAL PART NUMBER												
X	O	6	2	C	T	E	A	N	A	5	0	M
MODEL				FREQUENCY STABILITY	OTR	ENABLE/DISABLE	PACKAGE CODE	OPTIONS		FREQUENCY		

Surface Mount Oscillators



The XOSM-531 series is an ultra miniature package clock oscillator with dimensions 5.0 x 3.2 x 1.3 mm. It is mainly used in portable PC and telecommunication devices and equipment.

FEATURES

- 5 x 3.2 x 1.3 Miniature Package
- Tri-state enable/disable
- HCMOS compatible
- Tape and Reel
- IR Re-flow
- 1.8 V input voltage
- 100 % Lead (Pb)-free and RoHS compliant



RoHS
COMPLIANT

STANDARD ELECTRICAL SPECIFICATIONS

PARAMETER	SYMBOL	CONDITION	XOSM-531
Frequency Range	F_o		1.544 MHz ~ 100.000 MHz
Frequency Stability*		All Condition*	± 25 ppm, ± 50 ppm, ± 100 ppm
Operating Temperature	T_{OPR}		0 °C ~ 70 °C (-40 °C ~ +85 °C option)
Storage Temperature Range	T_{STG}		-55 °C ~ +125 °C
Power Supply Voltage	V_{DD}		1.8 V \pm 10 %
Aging (First Year)		25 °C \pm 3 °C	± 5 ppm
Supply Current	I_{DD}	1.544 MHz to 9.999 MHz	6 mA Max
		10.000 MHz to 34.999 MHz	7 mA Max
		35.000 MHz to 49.999 MHz	15 mA Max
		50.000 MHz to 100.000 MHz	25 mA Max
Output Symmetry	Sym	At $1/2 V_{DD}$	40/60 % (45/55 % Option)
Rise Time	T_r	10 % V_{DD} ~ 90 % V_{DD}	5 nS Max
Fall Time	T_f	90 % V_{DD} ~ 10 % V_{DD}	5 nS Max
Output Voltage	V_{OH}		90 % V_{DD} Min
	V_{OL}		10 % V_{DD} Max
Output Load	HCMOS Load		30 pF Max (15 pF typ.)
Start-up Time		T_s	10 mS Max
Pin 1, tri-state function			Pin 1 = H or open.... output active at pin 3 Pin 1 = L..... high impedance at pin 3

*Include: 25 °C tolerance, operating temperature range, input voltage change, aging, load change, shock and vibration.

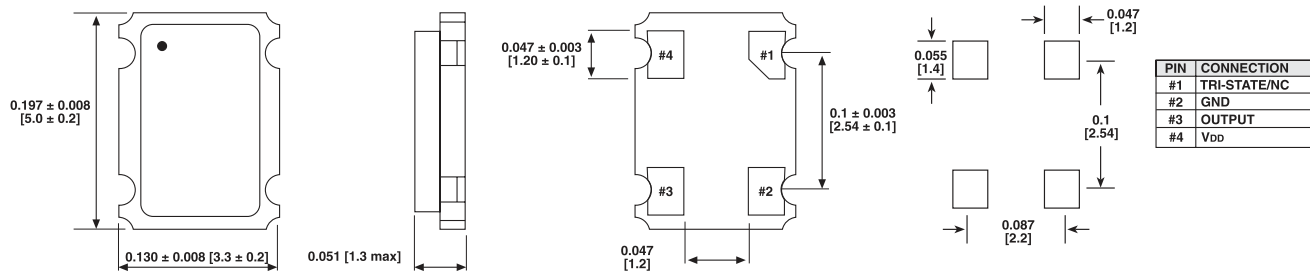
DIMENSIONS in inches [millimeters]



***note: A 0.01 μ F bypass capacitor should be placed between VDD(Pin4) and GND(Pin2) to minimize power supply line noise

ORDERING INFORMATION

XOSM-531 MODEL	B FREQUENCY STABILITY	R OTR	E ENABLE/DISABLE	50 M FREQUENCY/MHz	e4 JEDEC Lead (Pb)-Free STANDARD
	AA = 0.0025 % (25 ppm) A = 0.005 % (50 ppm) B = 0.01 % (100 ppm) Standard	Blank = Standard R = -40 °C to +85 °C	E = Disable to Tristate		

GLOBAL PART NUMBER

X	O	6	1	C	T	E	A	N	A	5	0	M
MODEL				FREQUENCY STABILITY		OTR	ENABLE/DISABLE	PACKAGE CODE	OPTIONS		FREQUENCY	

Tubes

PACKAGING SPECIFICATIONS in inches (millimeters)										
<p>Style A</p>										
<p>Style B</p>										
P/N	STYLE	A	B	C	D	E	F	G	L	QTY/TUBE
XO-53	A	0.031 [0.8]	0.433 [11.0]	0.622 [15.8]	0.177 [4.5]	0.531 [13.5]	0.339 [8.6]	0.087 [2.2]	20.08 [510.0]	25
XO-54	A	0.031 [0.8]	0.433 [11.0]	0.622 [15.8]	0.177 [4.5]	0.531 [13.5]	0.339 [8.6]	0.087 [2.2]	20.08 [510.0]	25
XO-543	A	0.031 [0.8]	0.433 [11.0]	0.622 [15.8]	0.177 [4.5]	0.531 [13.5]	0.339 [8.6]	0.087 [2.2]	20.08 [510.0]	25
XO-52	A	0.031 [0.8]	0.433 [11.0]	0.622 [15.8]	0.177 [4.5]	0.531 [13.5]	0.339 [8.6]	0.087 [2.2]	20.08 [510.0]	40
XO-523	A	0.031 [0.8]	0.433 [11.0]	0.622 [15.8]	0.177 [4.5]	0.531 [13.5]	0.339 [8.6]	0.087 [2.2]	20.08 [510.0]	40
XO-56	A	0.031 [0.8]	0.433 [11.0]	0.622 [15.8]	0.177 [4.5]	0.531 [13.5]	0.339 [8.6]	0.087 [2.2]	20.08 [510.0]	25
XOVC-23	A	0.031 [0.8]	0.433 [11.0]	0.622 [15.8]	0.177 [4.5]	0.531 [13.5]	0.339 [8.6]	0.087 [2.2]	20.08 [510.0]	25
XOSM-52	A	0.031 [0.8]	0.433 [11.0]	0.622 [15.8]	0.177 [4.5]	0.531 [13.5]	0.339 [8.6]	0.087 [2.2]	20.08 [510.0]	40
XOSM-57	B	0.024 [0.6]	0.26 [6.6]	0.094 [2.4]	0.098 [2.5]	0.079 [2.0]	–	–	15.16 [385.0]	50
XOSM-573	B	0.024 [0.6]	0.26 [6.6]	0.094 [2.4]	0.098 [2.5]	0.079 [2.0]	–	–	15.16 [385.0]	50

Surface Mount Tape and Reel

TAPE AND REEL SPECIFICATIONS in inches (millimeters)

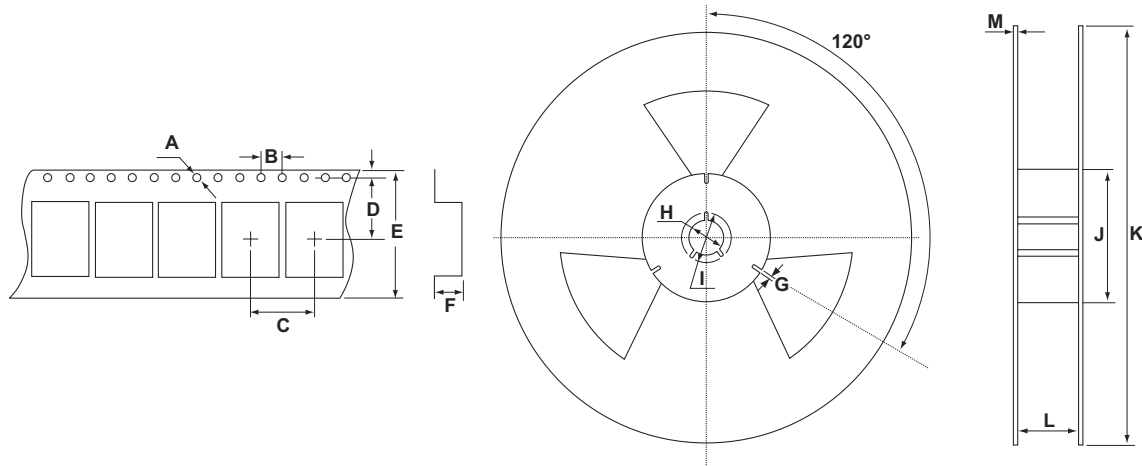

TAPE SPECIFICATIONS

MODEL	A	B	C	D	E	F	QTY/REEL
XT32P	Ø 0.059 (1.50)	0.157 (4.0)	0.315 (8.0)	0.295 (7.5)	0.630 (16.0)	0.154 (3.9)	1000
XT38P	Ø 0.059 (1.50)	0.157 (4.0)	0.315 (8.0)	0.295 (7.5)	0.630 (16.0)	0.106 (2.7)	1000
XT49M	Ø 0.059 (1.50)	0.157 (4.0)	0.472 (12.0)	0.453 (11.5)	0.945 (24.0)	0.171 (4.35)	1000
XT49ML	Ø 0.059 (1.50)	0.157 (4.0)	0.472 (12.0)	0.453 (11.5)	0.945 (24.0)	0.138 (3.5)	1000
XT46C	Ø 0.059 (1.50)	0.157 (4.0)	0.315 (8.0)	0.295 (7.5)	0.630 (16.0)	0.059 (1.5)	1000
XT57C	Ø 0.059 (1.50)	0.157 (4.0)	0.315 (8.0)	0.295 (7.5)	0.630 (16.0)	0.079 (2.0)	1000
XT36C	Ø 0.059 (1.50)	0.157 (4.0)	0.315 (8.0)	0.295 (7.5)	0.630 (16.0)	0.079 (2.0)	1000
XOSM-57/573/572/571	Ø 0.059 (1.50)	0.157 (4.0)	0.315 (8.0)	0.295 (7.5)	0.630 (16.0)	0.079 (2.0)	1000
XOSM-533/532/531	Ø 0.059 (1.50)	0.157 (4.0)	0.315 (8.0)	0.217 (5.5)	0.472 (12.0)	0.059 (1.5)	1000

REEL SPECIFICATIONS

MODEL	G	H	I	J	K	L	M
XT32P	0.098 (2.5)	Ø 0.531 (13.5)	0.850 (21.6)	3.917 (99.5)	12.99 (330)	0.630 (16.0)	0.091 (2.3)
XT38P	0.098 (2.5)	Ø 0.531 (13.5)	0.850 (21.6)	3.917 (99.5)	12.99 (330)	0.630 (16.0)	0.091 (2.3)
XT49M	0.098 (2.5)	Ø 0.531 (13.5)	0.850 (21.6)	3.917 (99.5)	12.99 (330)	0.945 (24.0)	0.091 (2.3)
XT49ML	0.098 (2.5)	Ø 0.531 (13.5)	0.850 (21.6)	3.917 (99.5)	12.99 (330)	0.945 (24.0)	0.091 (2.3)
XT46C	0.091 (2.3)	Ø 0.531 (13.5)	0.850 (21.6)	2.362 (60.0)	7.008 (178)	0.630 (16.0)	0.056 (1.4)
XT57C	0.091 (2.3)	Ø 0.531 (13.5)	0.850 (21.6)	2.362 (60.0)	7.008 (178)	0.630 (16.0)	0.056 (1.4)
XT36C	0.098 (2.5)	Ø 0.531 (13.5)	0.850 (21.6)	2.362 (60.0)	7.008 (178)	0.689 (17.5)	0.056 (1.4)
XOSM-57/573/572/571	0.098 (2.5)	Ø 0.531 (13.5)	0.850 (21.6)	2.362 (60.0)	7.008 (178)	0.689 (17.5)	0.056 (1.4)
XOSM-533/532/531	0.098 (2.5)	Ø 0.531 (13.5)	0.850 (21.6)	2.362 (60.0)	7.008 (178)	0.531 (13.5)	0.056 (1.4)

Packaging Specifications

Vishay Dale

Radial Lead Tape and Reel



PACKAGING SPECIFICATIONS in inches (millimeters)

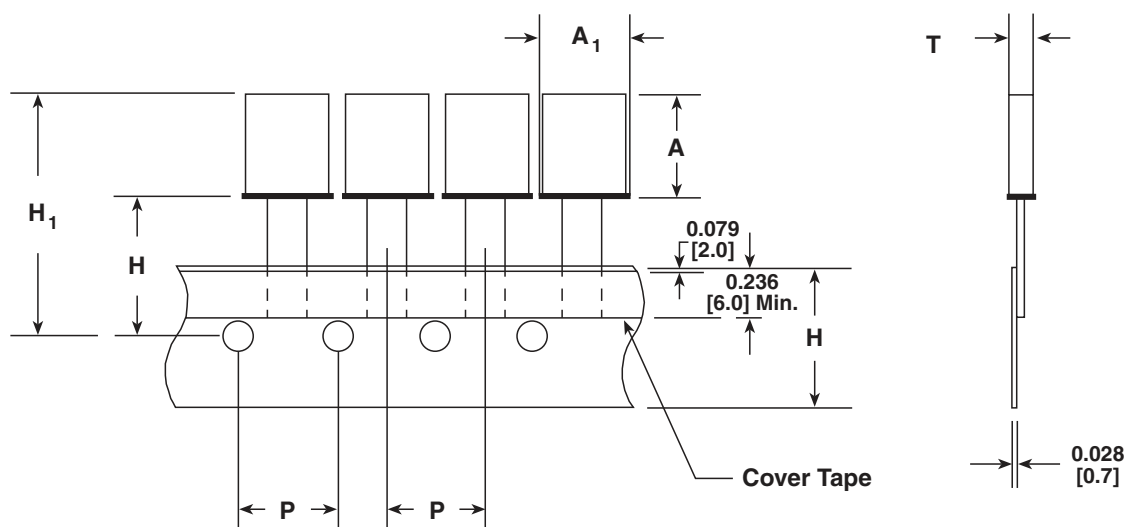

P/N	A	A ₁	H	H ₁	P	T
XT49S	0.146 [3.7]	0.453 [11.5]	0.709 [18.0]	0.945 [24.0] Max.	0.500 [12.7]	0.197 [5.0] Max.
XT49U	0.524 [13.3]	0.441 [11.2]	0.709 [18.0]	1.32 [33.6] Max.	0.500 [12.7]	0.197 [5.0] Max.
XTUM1	0.323 [8.2]	0.354 [9.0]	0.709 [18.0]	1.12 [28.5] Max.	0.500 [12.7]	0.197 [5.0] Max.

PACKAGING SPECIFICATIONS in inches (millimeters)

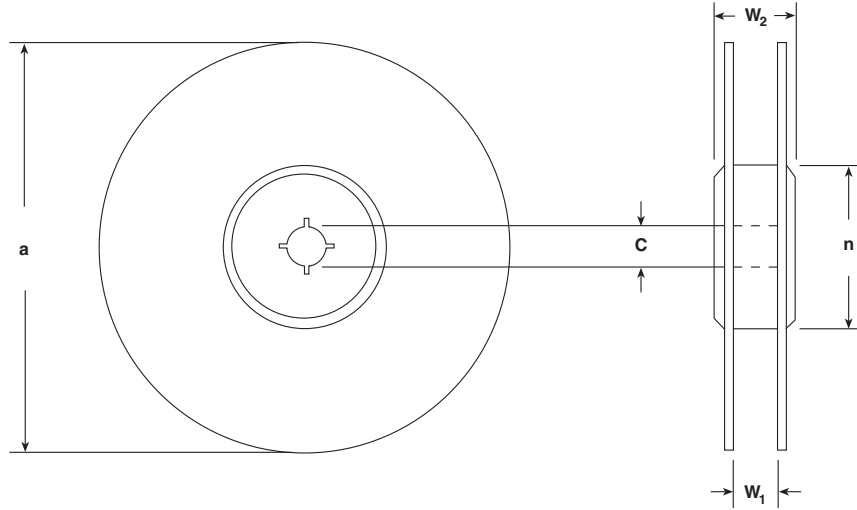

P/N	a	C	n	W ₁	W ₂	QTY/REEL
XT49S	14.57 [370.0] Max.	1.50 [38.0] Max.	3.15 [80.0] Max.	1.36 [34.5] Max.	2.20 [56.0] Max.	1000
XT49U	14.57 [370.0] Max.	1.50 [38.0] Max.	3.15 [80.0] Max.	1.73 [44.0] Max.	2.20 [56.0] Max.	1000
XTUM1	14.57 [370.0] Max.	1.50 [38.0] Max.	3.15 [80.0] Max.	1.54 [39.0] Max.	2.20 [56.0] Max.	1000

Crystals and Oscillators Packaging Methods

TAPE AND REEL in inches [millimeters]											
MODEL	PACKAGE CODE	SAP CODE	REEL SIZE	CARRIER TAPE WIDTH	COMPONENT PITCH	MINIMUM ORDER QUANTITY	ORDER MULTIPLE	PACKAGE CODE	SAP CODE	MINIMUM ORDER QUANTITY	ORDER MULTIPLE
XT26T	-	-	-	-	-	-	-	B04	A	1000	100
XT38T	-	-	-	-	-	-	-	B04	A	1000	100
XT38P	RC6	F	13	0.630 [16.0]	0.315 [8.0]	3000	3000	B04	A	200	100
XT32P	RF6	M	13	0.630 [16.0]	0.315 [8.0]	2000	2000	B04	A	200	100
XT49U	RF5	G	14.57	0.709 [18.0]	0.500 [12.7]	1000	1000	B04	A	500	100
XT49S	RF5	G	14.57	0.709 [18.0]	0.500 [12.7]	1000	1000	B04	A	500	100
XT49SL	RF5	G	14.57	0.709 [18.0]	0.500 [12.7]	1000	1000	B04	A	500	100
XT49M	RF7	H	13	0.087 [2.2]	0.531 [13.5]	1000	1000	B04	A	500	100
XT49ML	RF7	H	7	0.087 [2.2]	0.531 [13.5]	1000	1000	B04	A	500	100
XT36C	RF7	H	7	0.630 [16.0]	0.315 [8.0]	1000	1000	B04	A	100	100
XT57C	RF7	H	7	0.087 [2.2]	0.531 [13.5]	1000	1000	B04	A	100	100
XT46C	RF7	H	7	0.087 [2.2]	0.531 [13.5]	1000	1000	B04	A	100	100
XO-53	-	-	-	-	-	-	-	D07	D	100	25
XO-54	-	-	-	-	-	-	-	D07	D	100	25
XO-543	-	-	-	-	-	-	-	D07	D	100	25
XO-52	-	-	-	-	-	-	-	D08	L	120	40
XO-523	-	-	-	-	-	-	-	D08	L	120	40
XO-56	-	-	-	-	-	-	-	D07	D	1000	25
XOVC-23	-	-	-	-	-	-	-	D07	D	100	25
XOSM-52	-	-	-	-	-	-	-	D08	L	120	40
XOSM-55	RF7	H	13	0.945 [24.0]	0.472 [12.0]	1000	1000	D07	D	100	25
XOSM-553	RF7	H	13	0.945 [24.0]	0.472 [12.0]	1000	1000	D07	D	100	25
XOSM-57	RF7	H	7	0.630 [16.0]	0.315 [8.0]	1000	1000	D06	C	100	50
XOSM-573	RF7	H	7	0.630 [16.0]	0.315 [8.0]	1000	1000	D06	C	100	50
XOSM-572	RF7	H	7	0.630 [16.0]	0.315 [8.0]	1000	1000	D06	C	100	50
XOSM-571	RF7	H	7	0.630 [16.0]	0.315 [8.0]	1000	1000	D06	C	100	50
XOSM-533	RF7	H	7	0.472 [12.0]	0.315 [8.0]	1000	1000	B04	A	100	100
XOSM-532	RF7	H	7	0.472 [12.0]	0.315 [8.0]	1000	1000	B04	A	100	100
XOSM-531	RF7	H	7	0.472 [12.0]	0.315 [8.0]	1000	1000	B04	A	100	100



Environmental and Mechanical Specifications

ENVIRONMENTAL AND MECHANICAL SPECIFICATIONS		
DESCRIPTION	LIMITS/CONDITIONS	TEST PROCEDURES
Thermal Cycle	- 55° C, + 85° C, 5 cycles	MIL-STD-202, Method 107, Condition A
Gross Leak test	All units 100 % leak tested	MIL-STD-202, Method 112, Condition D
Fine Leak	Mass spectrometer leak rate less than 2×10^{-8} Atm. cc/sec of helium	MIL-STD-202, Method, Condition C
Moisture Resistance	95 % RH, + 25° to + 65° C, 10 cycles	MIL-STD-202, Method 106
Shock	1000g, 0.35 mS	MIL-STD-202, Method 213, Condition I
Vibration	10 - 55Hz, 0.06" D.A., 55 - 2000Hz, 20g	MIL-STD-202, Method 204, Condition D
Solderability	Minimum 95 % coverage	MIL-STD-202, Method 208
Resistance to Solvents	Isopropyl alcohol, terpene and monethanolamine solutions	MIL-STD-202, Method 215

TEST CIRCUITS

TTL

The TTL test circuit diagram shows a power supply of +5.0 V/3.3 V connected to an ammeter (A) and a voltmeter (V). A 0.01 μF capacitor is connected between the supply and ground. The Vcc pin of the device is connected to the supply, and the Gnd pin is connected to ground. The Output pin is connected to a Test Point. A dashed box labeled 'TTL Load' contains a resistor (RL = 390 ohms for 10 TTL) and a capacitor (CL = 15 pF) connected to ground.

HCMOS

The HCMOS test circuit diagram shows a power supply of +5.0 V/3.3 V connected to an ammeter (A) and a voltmeter (V). A 0.01 μF capacitor is connected between the supply and ground. The Vcc pin of the device is connected to the supply, and the Gnd pin is connected to ground. The Output pin is connected to a Test Point. A dashed box labeled 'HCMOS Load' contains a capacitor (CL = 50 pF or 15 pF) connected to ground.

Soldering Profiles

RECOMMENDED PROFILES FOR SOLDER REFLOW

Infrared Reflow

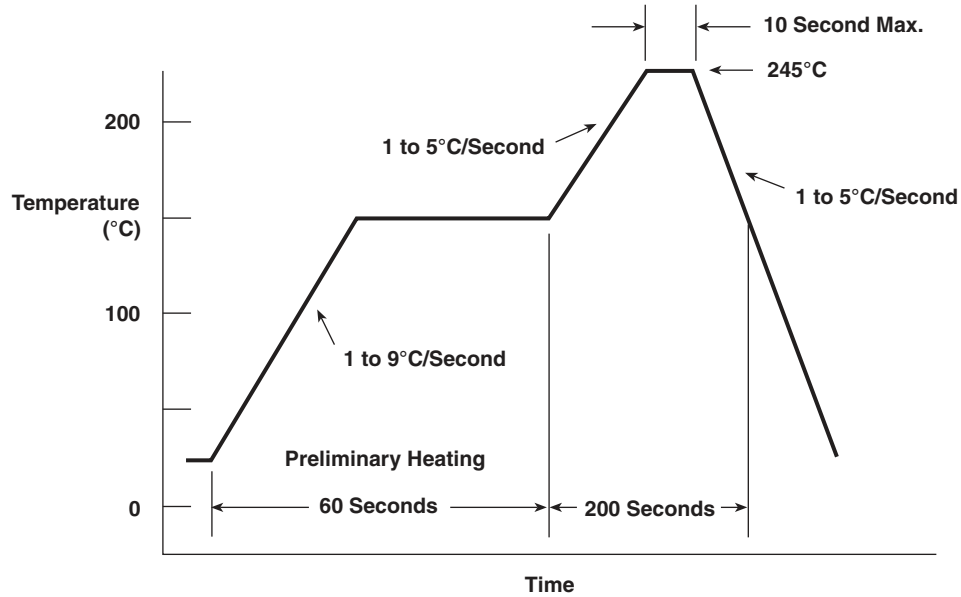

Vapor Phase Reflow

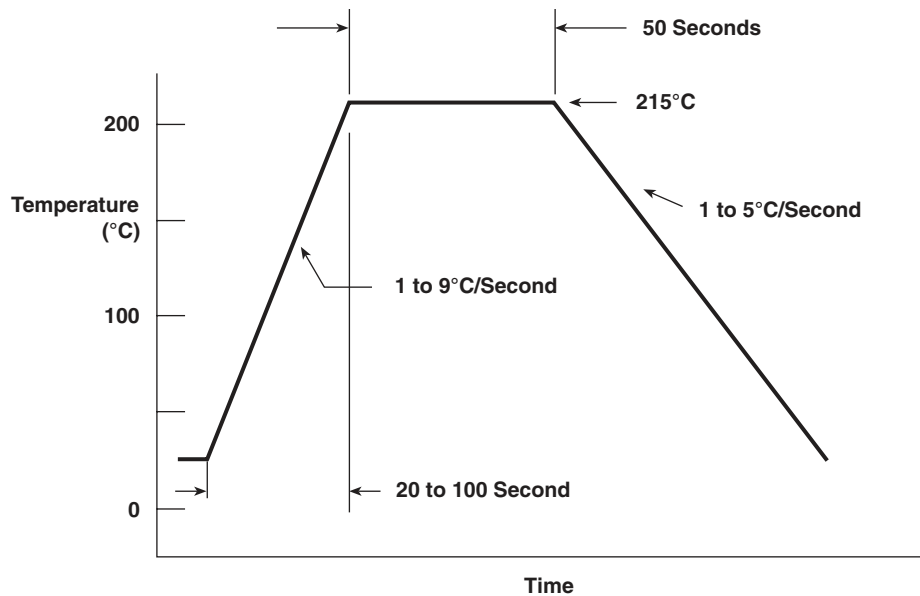

CROSS REFERENCE - CRYSTALS AND OSCILLATORS

VISHAY P/N	ABRACON	AVX KYOCERA	CTS	ECS	ECLIPTEK	EPSON	FOX	M-TRON	PLETRONICS	RALTRON	RXD	SARONIX	VALPEY
XT126T	AB26T	KF-26G-12P0200	—	ECS-2X6	EC26T	C-002RX 12.5	NC26	MMCC-2	WX26	R26	WC-26E	NTF 3226	NC26
XT138T	AB38T	KF-38G-12P0200	—	ECS-3X8	EC38T	C-001R 12.5	NC38	MMCC-1	WX	R38	WC-38E	NTF 3238	NC38
XT149S	ABL	—	ATS	—	EC2	—	HC49S	ATS-49	LP49	AS	MP35	49S	VM6S
XT149U	AB	—	MP	—	EC OR 8EC	—	HC49U	MP-1SRMP-1	MP49	A	MP49	NMP /NYP	VM6
XTUM1	ABU	—	—	—	ECUM	—	UM1	UM-1	UM1	—	—	UM1	UM1
XT132PA	—	—	—	—	ECP5M310T	MC-406	—	—	—	—	—	32S12A	VFSMC-2
XT132PB	—	—	—	—	—	MC-405	FSM327	—	—	—	—	32S12B	VFSMC-1
XT138PA	—	—	—	—	ECP5M 29 T	MC306	FSR327	SX1555	SM20S	—	—	32S12C	—
XT146C	ECCM5	KSX-36	—	ECX-64	—	FA368	FM	PP	SM12H	—	—	NKS6	—
XT149M	ABLS	—	ATS-SM	—	EC2SM	—	HC49SD	ATSM-49	SM42	AS-SMD	MP35L	49SMLB	VM6SSM-2
XT136C	ABM5	—	—	—	—	—	—	PX	—	H180A	—	—	—
XT157C	ABMM	—	SMLP	—	—	—	FD	—	—	H13K	—	NKS 7	VFSXG-2
XO-52B	ACH	KHO-HC1CS	MXO45HS	ECS-2100	EC1100HS	—	—	MH13FAD	SQ2200	CO12100	HHSC2 OR HTHSC2	NCH 039/069/089 C	VF70
XO-52BE	ACHA	KHO-HC1CSE	MXO45HST	ECS-2200	EC100HSTS	*SG531	H5C-2 OR F3020	MH13EAD	SQ3300	CO19100	NNSCR2 OR HRC2	NTH 039/069/089 C	VF70T
XO-523B	—	—	—	—	EC1300HS	—	—	—	SQ2200V	—	—	—	—
XO-523BE	—	—	—	—	EC1300HST	—	—	—	SQ3300V	—	—	—	—
XO-53B	—	KXO-01-1	MXO45	ECS 100A	—	—	F1100E	MT013FAD	—	CO1100	T2	NCT 040/050/070 C	VF150
XO-53BE	—	—	MXO45T	—	—	*SG51	F100HT	MT013EAD	—	—	—	NTT 040/050/070 C	VF150T
XO-54B	ACO	KXO-HC 1CS	—	ECS 400A	EC1100	—	F5C	MHO-13FAD	P1100-HC	CO6100	HSC2 OR THSC2	NCH 039/060/080 C	VF140
XO-54BE	ACOA	KHO-HC 1CSE	—	ECS 1000E	EC1100TS	—	F5C-2 OR F3000	MHO-13EAD	P1100-3SV	CO15100	HSCR2 OR RC2	NTH 030/060/080 C	VF140T
XO-543B	—	—	—	—	EC1300	—	—	—	P1100-HCV	—	—	—	—
XO-543BE	—	—	—	—	EC1300TS	—	—	—	P1100-3SV	—	—	—	—
XOVC-23	—	—	—	—	EC3100	—	VCXO-B	MV1	VC-1	VC 7025	—	—	—
XOSM-55	ASMA	—	—	ECS-9F	EC1400SJTS	SG615P	F5O-2	MHR13TAJ	SM1100C	CO66610	—	NTH 03/06/08 HC	—
XOSM-553	—	—	—	—	EC1500SST	—	—	—	—	CO63100	—	NTH 03/06/08 HC3	—
XOSM-57BE	ASLA	K50-HC 1 CS E	CB3-2C	ECS-3951C	EC2500TS	—	F3345 OR F3355	M113TAN	SM7700H	CO4910	—	S1700C OR 1750C	VF1 / VF5
XOSM-573BE	ASVA	K50-3C1E	CB3LV-2C	ECS-3953C	EC2600TS	—	F4100	M213TAN	—	CO4310	—	S1703C	VF3
XOSM-572	—	K53-2C	CB2V5	ECS-5725	EC2700TS	—	F4400	M2250	—	—	—	S1614	—
XOSM-571	—	K53-1C	CB1V8	ECS-5718	EC2900TS	—	F4500	M2180	—	CO418	—	S1612	—
XOSM-533	ASFLP	FXO-61F2	636L	ECS-3963	EC3600TS	—	F530L	M2034	—	COM23	—	S1633	G3
XOSM-532	ASFL2	—	636N	ECS-3525	EC3700TS	—	F540L	—	—	—	—	S1634	—
XOSM-5531	ASFL3	—	636M	ECS-3518	EC3900TS	—	F510L	—	—	—	—	—	—

*The Vishay product is pin compatible in a metal can. The SG-51 and SG531 are in a molded package.

NOTE: The above cross reference is the suggested substitute for key competitors part numbers. Vishay does not accept any responsibility for any errors that result from this cross reference. Please contact factory for other crosses.















ONLINE INFORMATION

For product information and current list of sales offices,
representatives and distributors, visit our website:

www.vishay.com

WORLDWIDE SALES CONTACTS

THE AMERICAS

UNITED STATES

VISHAY AMERICAS
ONE GREENWICH PLACE
SHELTON, CT 06484
UNITED STATES
PH: +1-402-563-6866
FAX: +1-402-563-6296

ASIA

SINGAPORE

VISHAY INTERTECHNOLOGY
ASIA PTE LTD.
25 TAMPINES STREET 92
KEPPEL BUILDING #02-00
SINGAPORE 528877
PH: +65-6788-6668
FAX: +65-6788-0988

P.R.C.

VISHAY INTERTECHNOLOGY
ASIA PTE. LTD.
(SHANGHAI REPRESENTATIVE OFFICE)
ROOM D, 15F, SUN TONG INFOPORT PLAZA
55 HUAI HAI WEST ROAD
200030 SHANGHAI
P.R. OF CHINA
PH: +86-21-6283-1036
FAX: +86-21-6283-1039

JAPAN

VISHAY JAPAN CO., LTD.
GE EDISON BUILDING, SHIBUYA 3F
3-5-16 SHIBUYA
SHIBUYA-KU
TOKYO 150-0002
JAPAN
PH: +81-3-5464-6411
FAX: +81-3-5464-6433

EUROPE

GERMANY

VISHAY EUROPE SALES GMBH
GEHEIMRAT-ROSENTHAL-STR. 100
95100 SELB
GERMANY
PH: +49-9287-71-0
FAX: +49-9287-70435

FRANCE

VISHAY S.A.
199, BLVD DE LA MADELEINE
06003 NICE, CEDEX 1
FRANCE
PH: +33-4-9337-2920
FAX: +33-4-9337-2997

NETHERLANDS

VISHAY BCCOMPONENTS B.V.
HURKESTRAAT 31
P.O. BOX 8766
5652 AH EINDHOVEN
NETHERLANDS
PH: +31-40-2590-700
FAX: +31-40-2590-777

One of the World's Largest

Manufacturers

of Discrete Semiconductors and Passive Components

**World Headquarters**

63 Lincoln Highway
Malvern, PA 19355-2143
United States

One of the World's Largest
Manufacturers
of Discrete Semiconductors and Passive Components



© Copyright Vishay Intertechnology, Inc.
Registered Trademarks of Vishay Intertechnology, Inc.
All rights reserved. Printed in the United States.
Specifications subject to change without notice.

www.vishay.com