

**H**

Thru-Hole

SMD

TTL / CMOS

1.8V

2.5V

3.3V

5.0V

Min.  
20KHzMax.  
160MHz

## Applications

- CPU , Graphics , Multimedia A / V clocks
- Fast Ethernet and Gigabit Ethernet clocks
- MPEG / DVD / HDTV clocks
- NTSC / PAL encoder / decoder clocks
- Laser engine pixel / set - top clocks
- PLL / synthesizer clocks
- OC-3 , OC-12 , OC-48 and OC-192 clocks
- Fibre channel and ADSL clocks
- SONET / SDH / ATM clocks



RoHS Compliance

General Specifications [ TA = +25°C , V<sub>DD</sub>= at specified voltage , Load : 15 pF ]

Model		" H " series				
Input Voltage ( V <sub>DD</sub> )		+ 1.8V D.C.±5%	+ 2.5V D.C.±5%	+ 3.3 V D.C.±5%	+ 5.0V D.C.±10%	
		code is " 18 "	code is " 25 "	code is " 3 "	code is " 5 "	
Frequency Range		1.8 MHz ~ 60 MHz	0.3 MHz ~ 125 MHz	20KHz ~ 130 MHz	20 KHz ~ 160 MHz	
Output Wave Form		CMOS	CMOS	T T L / CMOS	T T L / CMOS	
Output Logic High " 1 "	T T L			2.4 V ( min. )	2.4 V ( min. )	
	CMOS	1.62 V ( min. )	2.25 V ( min. )	2.97 V ( min. )	4.5 V ( min. )	
Output Logic Low " 0 "	T T L			0.4 V ( max. )	0.4 V ( max. )	
	CMOS	0.18 V ( max. )	0.25 V ( max. )	0.33 V ( max. )	0.5 V ( max. )	
Frequency Stability <sup>(1)</sup> Codes		Frequency Stability over Operating Temperature Range	± 25 ppm	± 50 ppm	± 100 ppm	If non-standard , please enter the desired stability after the " C " or " I " For example : " C20 " ±20 ppm over -10°C to +70°C ; " I20 " ± 20 ppm over -40°C to +85°C
		Commercial ( -10°C to +70°C )	A	B	C	
		Industrial ( -40°C to +85°C )	D	E	F	
Output Load	T T L	2 ~ 10 (LS) T T L gates				
	CMOS	15 pF typical; 30 pF load for frequencies up to 70 MHz ; Contact Mercury for 50 pF load				
Rise Time ( Tr )	T T L	10 n sec.(max.) ; 3 n sec.(typical) . Measured between 0.4V <sub>DC</sub> ↔ 2.4V <sub>DC</sub> ( RL=390Ω ; CL = 15pF )				
Fall Time ( Tf )	CMOS	10 n sec.(max.) ; 3 n sec.(typical) . Measured between 10% to 90% wave form ( CL=15pF )				
Duty Cycle	T T L	40% (min.) , 60%(max.) Measured at +1.4V				
	CMOS	40% (min.) , 60%(max.) Measured at 50% of wave form [ 50% ± 5% is also available , add " S " at the end of the part number				
Start -Up Time (Ts)		10 m sec. (max.) ; 5 m sec. (typical)				
Current Consumption		10 ~ 45 mA ( frequency dependent )				
Storage Temperature		- 50°C to 100°C				
Aging		±5 ppm per year (max.)				
Tri-State Option.		Output is high impedance when " 0 " is applied to pin 1 . Disable time is 150 n sec. max. Add " T " in part number for Tri-State option				

Mercury [www.mercury-crystal.com](http://www.mercury-crystal.com)

# Clock Oscillators [ TTL / CMOS ]

Outline Dimensions ( Unit : mm ) , Suggested pad Layout for SMDs

[ Please refer to page 3 for product series selections . ]

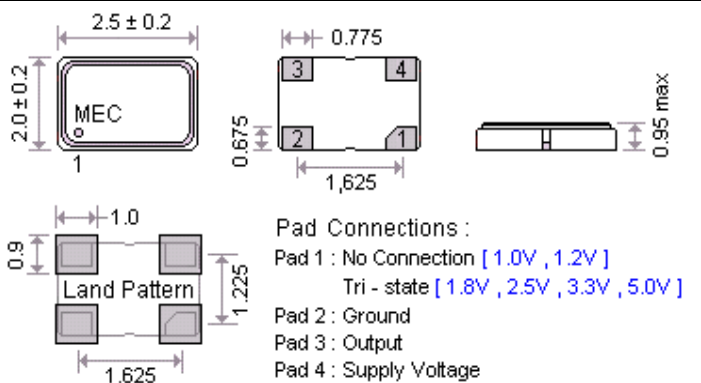
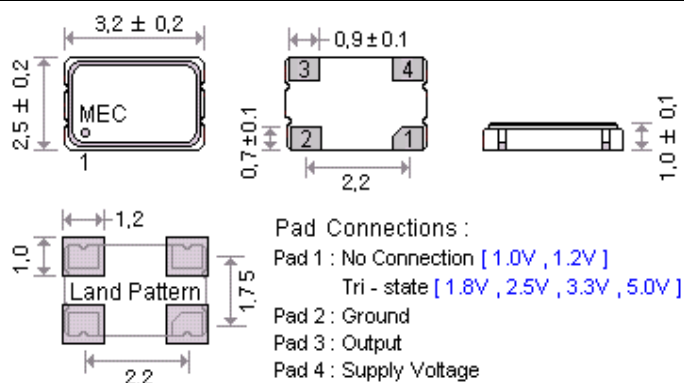
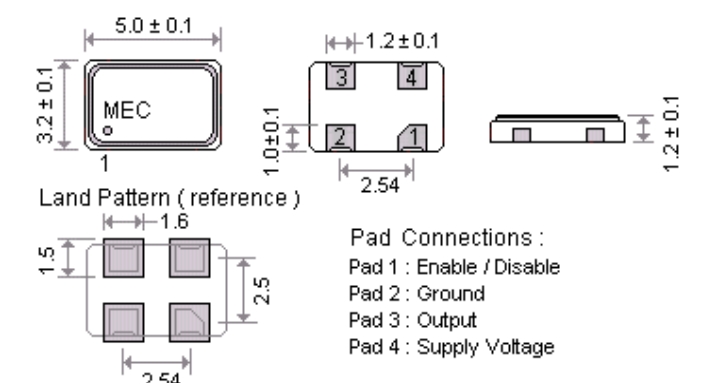
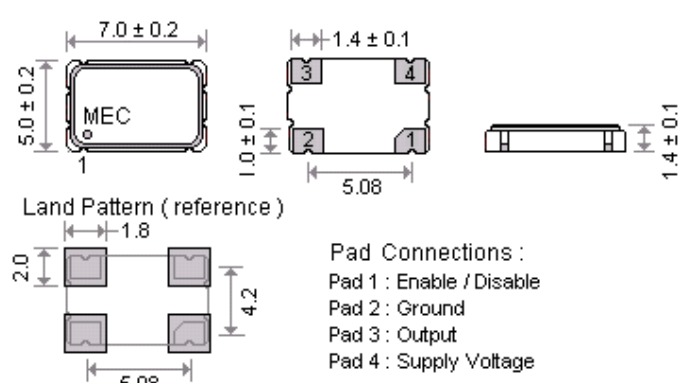
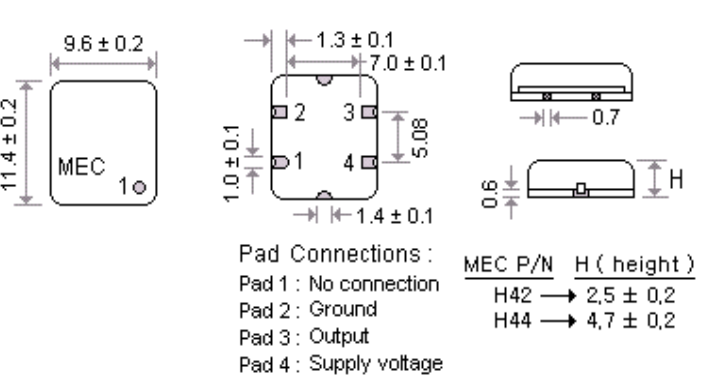
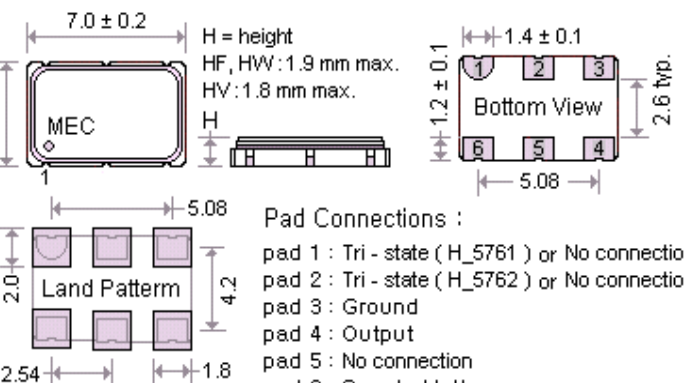
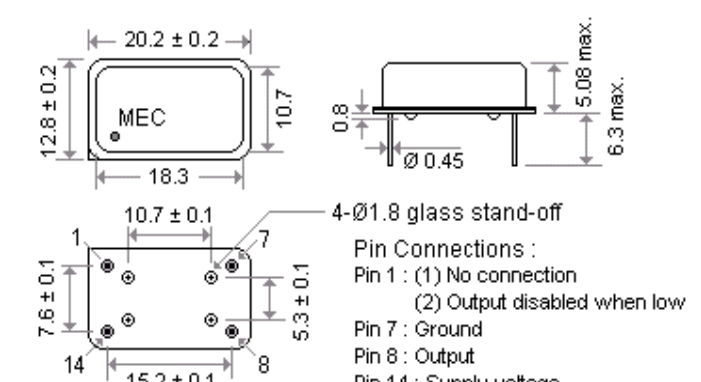
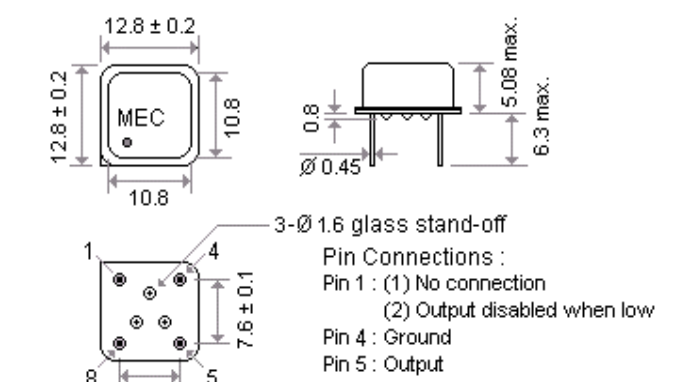
<p style="text-align: center;">[ H22 ]</p>  <p><b>Pad Connections :</b>          Pad 1 : No Connection [ 1.0V , 1.2V ]                    Tri - state [ 1.8V , 2.5V , 3.3V , 5.0V ]          Pad 2 : Ground          Pad 3 : Output          Pad 4 : Supply Voltage</p>	<p style="text-align: center;">[ H32 ]</p>  <p><b>Pad Connections :</b>          Pad 1 : No Connection [ 1.0V , 1.2V ]                    Tri - state [ 1.8V , 2.5V , 3.3V , 5.0V ]          Pad 2 : Ground          Pad 3 : Output          Pad 4 : Supply Voltage</p>						
<p style="text-align: center;">[ H_53 ]</p>  <p><b>Pad Connections :</b>          Pad 1 : Enable / Disable          Pad 2 : Ground          Pad 3 : Output          Pad 4 : Supply Voltage</p>	<p style="text-align: center;">[ SWO ] , [ H_57 ]</p>  <p><b>Pad Connections :</b>          Pad 1 : Enable / Disable          Pad 2 : Ground          Pad 3 : Output          Pad 4 : Supply Voltage</p>						
<p>[ H42 , HF42 , HW42 , HV42 ] , [ H44 , HF44 , HW44 , HV44 ]</p>  <table border="1" style="margin-left: auto; margin-right: auto;"> <thead> <tr> <th>MEC P/N</th> <th>H ( height )</th> </tr> </thead> <tbody> <tr> <td>H42</td> <td>2.5 ± 0.2</td> </tr> <tr> <td>H44</td> <td>4.7 ± 0.2</td> </tr> </tbody> </table> <p><b>Pad Connections :</b>          Pad 1 : No connection          Pad 2 : Ground          Pad 3 : Output          Pad 4 : Supply voltage</p>	MEC P/N	H ( height )	H42	2.5 ± 0.2	H44	4.7 ± 0.2	<p>[ HF5761 , HW5761 , HV5761 ] , [ HF5762 , HW5762 , HV5762 ]</p>  <p><b>Pad Connections :</b>          pad 1 : Tri - state ( H_5761 ) or No connection          pad 2 : Tri - state ( H_5762 ) or No connection          pad 3 : Ground          pad 4 : Output          pad 5 : No connection          pad 6 : Supply Voltage</p>
MEC P/N	H ( height )						
H42	2.5 ± 0.2						
H44	4.7 ± 0.2						
<p style="text-align: center;">[ H14 , HF14 , HW14 , HV14 ]</p>  <p><b>Pin Connections :</b>          Pin 1 : (1) No connection                    (2) Output disabled when low          Pin 7 : Ground          Pin 8 : Output          Pin 14 : Supply voltage</p>	<p style="text-align: center;">[ H8 , HF8 , HW8 , HV8 ]</p>  <p><b>Pin Connections :</b>          Pin 1 : (1) No connection                    (2) Output disabled when low          Pin 4 : Ground          Pin 5 : Output          Pin 8 : Supply voltage</p>						

**Mercury** [www.mercury-crystal.com](http://www.mercury-crystal.com)

# Clock Oscillators [ T T L / CMOS ]

## Part Number Format and Examples

	[ 1 ]	[ 2 ]	[ 3 ]	-	[ 4 ]	[ 5 ]	-	[ 6 ]
	Supply Voltage	Holder Type	G		Frequency Stability	T		Center Frequency
Examples	(1)	18	SWO	-	B	T	-	25.000
	(2)	5	H14	G	-	C30	-	10.000
	(2)	3	HDW5761	-	E	-	-	156.250

Ex (1) : 18SWO - BT - 25.000 [ 1.8V , SWO type , ±50ppm from -10°C to 70°C , Tri-state , 25.000MHz , ]

Ex (2) : 5H14G - C30 - 10.000 [ 5.0V , H14 type , RoHS , ±30ppm from -10°C to 70°C , 10.000MHz ]

Ex (3) : 3HDW621G - E - 156.250 [ 3.3V , ( HDW62 type , Tri-state on pin 1 ) , RoHS , ±50ppm from -40°C to 85°C , 156.250MHz ]

[1]	Supply voltage , " 1 " for +1.0V ; " 12 " for +1.2V ; " 18 " for +1.8V ; " 25 " for +2.5V ; " 28 " for +2.8V ; " 3 " for +3.3V ; " 5 " for +5.0V	
[2]	Holder Type	
[3]	Please add "G" after the " type code " for RoHS compliant ( Does not apply to SWO , H_53 , H_32 , H22 , H_576_ , H_534 series )	
[4]	-10°C ~ 70 °C	" A " ± 25ppm ; " B " ± 50ppm ; " C " ± 100ppm ; If non-standard please enter the desired stability after " C " , for example " C15 " : represents ±15ppm over -10 to +70°C
	-40°C ~ 85 °C	" D " ± 25ppm ; " E " ± 50ppm ; " F " ± 100ppm ; If non-standard please enter the desired stability after " I " , for example " I20 " : represents ±20ppm over -40 to +85°C
[5]	" T " for Tri-state , Leave this space blank if no connection on pin 1 or pad 1 .	
[6]	Frequency in MHz	
	Assigned by Mercury if customer spec , (1) : S ---- duty cycle ± 5% , ex : " - S " ; (2) : 50p ---- output load 50pF , ex : " - 50p "	

### T T L / HCMOS Square Wave Test Circuit

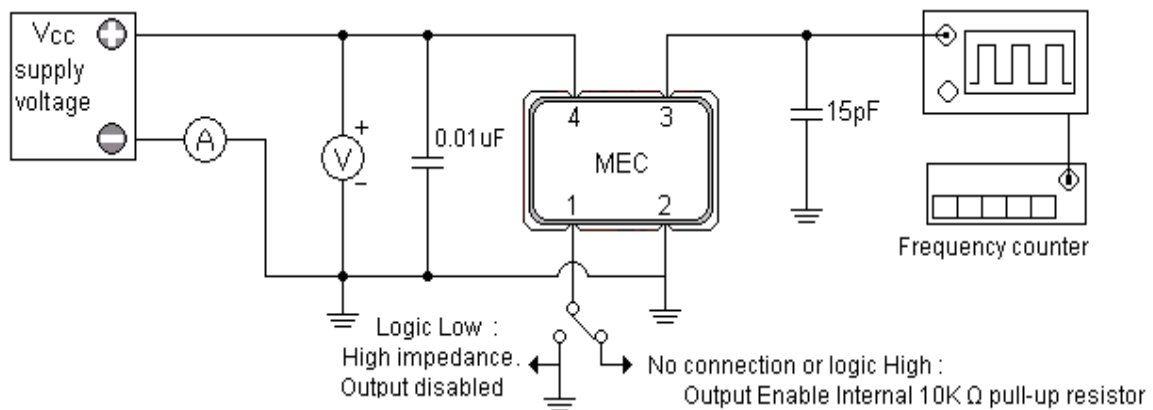

### T T L / HCMOS Output Wave Form

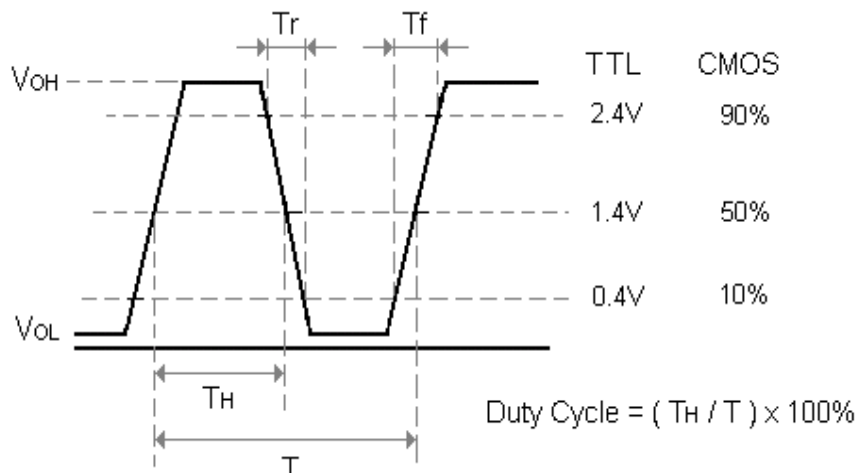

Mercury [www.mercury-crystal.com](http://www.mercury-crystal.com)