

AN5633K

SECAM-PAL Signal-Conversion IC

Overview

The AN5633K is an integrated circuit designed for conversion from SECAM color-signal to quasi-PAL color signal that is line-sequential 2-phase quadrature modulation.

Features

- Reduction of line-crawling by line-sequential detection (12dB as compared with the conventional one)
- SECAM/PAL discriminating capability is improved by detecting color killer voltage of PAL demodulation IC.
- Reduced external parts number like transformer, and adjustment processes

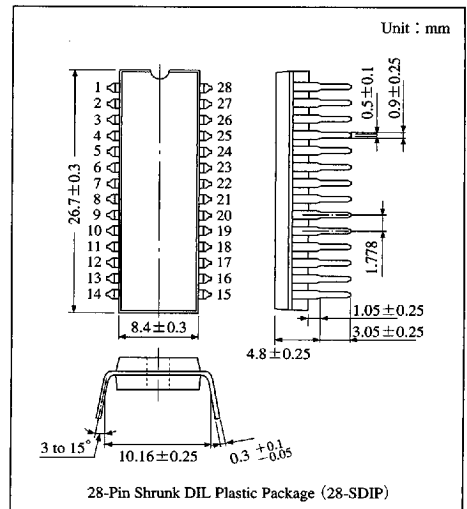

Block Diagram

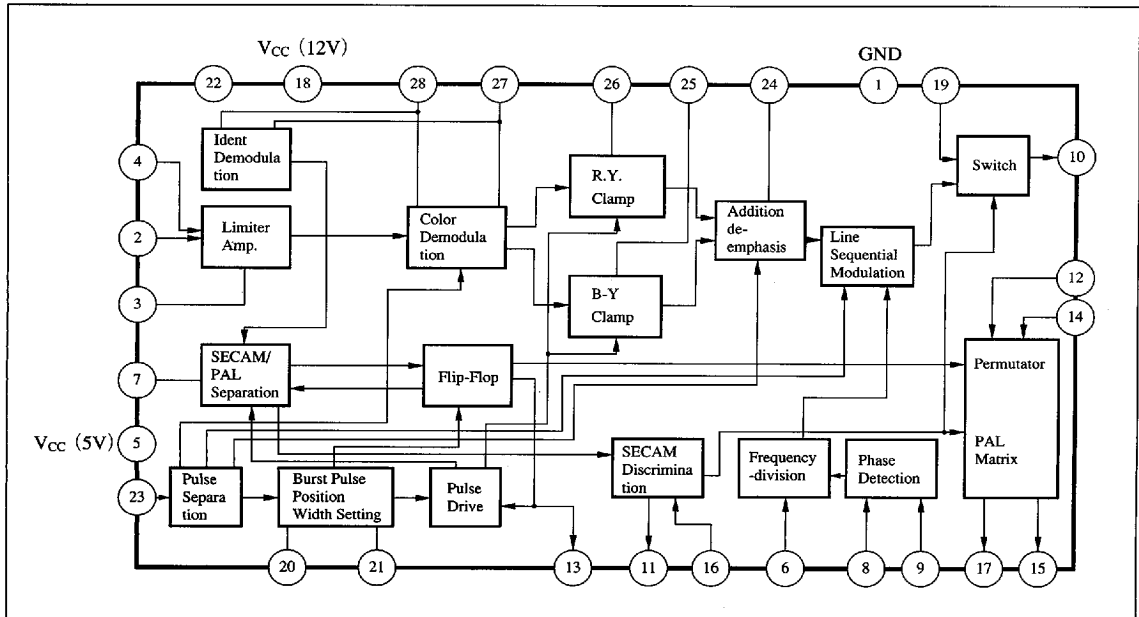

6932852 0014379 787

Panasonic

■ Absolute Maximum Ratings (Ta = 25°C)

Parameter	Symbol	Rating		Unit
Supply voltage	V _{CC}	14.4		V
Supply current	I _{CC}	82.7		mA
Circuit voltage	V ₂ , V ₄ , V ₁₁ , V ₁₃ , V ₁₆ , V ₂₂ , V ₂₃ ,	0	V ₁₈₋₁	V
	V ₅	0	6	
	V ₆	0	8	
	V ₁₂ , V ₁₄ , V ₁₉ ,	0	7	
Circuit current	I ₈	-1	0	mA
	I ₉	-3	0	
	I ₁₃	0	10	
	I ₂₀ , I ₂₁	-0.05	2	
Power dissipation	P _D	1142		mW
Storage temperature	T _{stg}	-55 to +150		°C
Operating ambient temperature	T _{opr}	-20 to +70		°C

■ Recommended Operating Range (Ta = 25°C)

Parameter	Symbol	Range
Operating supply voltage range	V _{CC}	9.6V to 14.4V

ICs for
TV

■ Electrical Characteristics (Ta = 25°C)

Parameter	Symbol	Condition	min	typ	max	Unit
DC Section						
Circuit current 12V	I _{CC1}	V _{CC1} = 12V, V _{CC2} = 5V,	37	50	63	mA
Circuit current 5V	I _{CC2}	V _{CC1} = 12V, V _{CC2} = 5V,	10	13	16	mA
AC Section						
Chroma Section						
SECAM input signal limiting	V _{O(lim)}	4.433618MHz input of Pin④ 10 to 300mV _{PP} output of Pin⑳	-1	0	1	dB
Limiter amp. gain	G _{V(lim)}	Ratio of 4.433618MHz input of Pin④ to 1mV _{PP} output of Pin⑳	28	32	36	dB
SECAM demodulator color difference ratio (B-Y/R-Y)	B-Y/R-Y	SECAM color bar input of Pin④ : 200mV _{PP} Ratio of B of DB to R of DR of Pin㉑ when the white levels of DB and DR of Pin㉑ are matched	0.67	0.74	0.81	Times
SECAM output signal voltage	e _{O(SECAM)}	SECAM color bar input of Pin④ : 200mV _{PP} R of output DR of Pin㉑ when the white levels of DB and DR of Pin㉑	60	180	300	mV _{PP}
Ratio of burst to chroma	$\frac{e_{O(SECAM)}}{e_{O(Burst)}}$	SECAM color bar input of Pin④ : 200mV _{PP} Ratio of burst to R of output DR of Pin㉑ when the white levels of DB and DR of Pin㉑	1.8	2.6	3.4	Times
PAL input-signal voltage	V _{i(PAL)}	PAL input signal of Pin㉑	—	—	1100	mV _{PP}
PAL output-signal voltage	e _{O(PAL)}	PAL input of Pin㉑ : 750mV _{PP} , output of Pin㉑	490	620	750	mV _{PP}
Discrimination Section						
Killer tolerance	e _K	Killer ON level to SECAM color bar input of Pin④ : 0dB (100mV _{PP})	-38	-31	-24	dB
Killer detection-voltage SECAM color	V _{11-1 SECAM}	Voltage of Pin㉑ when SECAM color bar input of Pin④ is -17dB	0	0.25	0.5	V
Killer detection-voltage SECAM off	V _{11-1 OFF}	Voltage of Pin㉑ when SECAM color bar input of Pin④ is -43dB	0.5	1.3	2.1	V

■ 6932852 0014380 4T9 ■

Panasonic

■ Electrical Characteristics (cont.) (Ta=25°C)

Parameter	Symbol	Condition	min	typ	max	Unit
Discrimination Section (cont.)						
Ident detection voltage PAL	V_{I1-PAL}	Voltage of Pin① when PAL color bar input burst of Pin④ is 150mV _{PP}	0.5	1.3	2.1	V
Pulse Input						
BLK detection voltage	V_{BLK}	Blanking pulse input voltage range of Pin②	1	1.5	2	V
H pulse detection voltage	V_H	H pulse input voltage range of Pin②	3	3.5	4	V
Burst gate pulse detection voltage	V_{BGP}	Burst gate pulse input voltage range of Pin②	6.5	7	7.5	V
Burst Phase Width Adjustment Section						
Comparator threshold level	V_{21LH}	Voltage of Pin② at which L is changed to H when 3kΩ V _{CC} of Pin② and 100μA of Pin② are applied	2.6	3.1	3.6	V
SECAM Switch, PAL Matrix						
PAL amplification	A_{PAL}	Gain of Pin⑫ input to Pin⑮ output, in case of SECAM	0.9	1.1	1.3	Times
PAL amplification error	ΔA_{PAL}	Error between gain of Pin⑫ input to Pin⑮ output, and gain of Pin⑭ input to Pin⑮ output	0	5	10	%
SECAM amplification	A_{SECAM}	Gain of Pin⑫ input to Pin⑮ output, in case of PAL	1.8	2.2	2.6	Times
De-emphasis Switch Output						
De-emphasis switch output DR	V_{13-IDR}	Pin⑬ output when V _{CC1} = 12V, Pin④ is SECAM color bar DR input	11	12	13	V
De-emphasis switch output DB	V_{13-IDB}	Pin⑬ output when V _{CC1} = 12V, Pin④ is SECAM color bar DB input	0	0.25	0.5	V

6932852 0014381 335

Panasonic

Pin Descriptions

Pin No.	Pin name	Typ. waveform	Description	Equivalent circuit
1	GND	—	GND pin.	—
2	Limiter feedback	—	Filter pin for keeping DC balance of limiter circuit.	
3				
4	SECAM signal input	<p>Pin④ signal</p> <p>Amplitude almost becomes flat after passing through the bell filter.</p>	SECAM input pin. PAL signal after input is separated at the latter-Ident section and the switch selection according to PAL is made.	
5	Power supply (5V)	—	5V power pin.	—
6	8.8MHz CW input		Input 8.8MHz of the AN5601K.	
7	System discrimination hold capacitance	—	Filter pin for holding the result discriminated by the system at the Ident section.	
8	Phase detection	—	Pin for inputting the result of chroma-carrier-phase of quasi-PAL signal discriminated by the AN5601K. Proper phase is given by the entire system.	
9				
10	Output (PAL/quasi-PAL)	<p>Pin⑩ signal</p> <p>(quasi-PAL)</p>	Pin for output signal which was converted into the quasi-PAL signal of SECAM.	

6932852 0014383 108

Panasonic

■ Pin Descriptions (cont.)

Pin No.	Pin name	Typ. waveform	Description	Equivalent circuit
11	System discriminating switch	—	Output pin for determining whether the signal input to Pin④ is PAL or SECAM. It also has the function to switch the internal system manually.	
12	Direct signal input		Pin for signal which is directly input to the PAL matrix in case of PAL and to the permutator circuit in case of SECAM. Connect to the ACC output pin of the AN5601K.	
13	De-emphasis switch		Pin for switching the filter for de-emphasizing Pin④.	
14	Delay signal input		Pin for 1H-delayed signal which is input to the PAL matrix in case of PAL and to the permutator circuit in case of SECAM.	
15	R-Y signal output		Continuous modulation R-Y signal output pin.	
17	B-Y signal output		Continuous modulation B-Y signal output pin.	
16	PAL color killer discrimination input	—	Pin for inputting color killer discriminating voltage of the AN5601K. The PAL/SECAM discriminating capability is increased by the internal logic circuit.	

ICs for TV

■ 6932852 0014384 044 ■

Panasonic

■ Pin Descriptions (cont.)

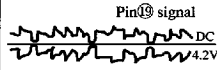
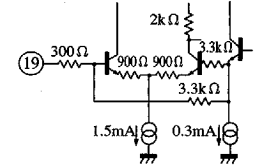
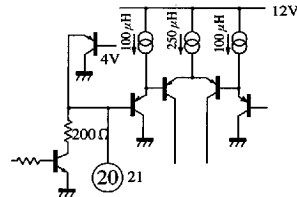
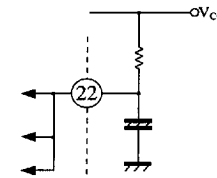
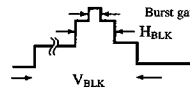
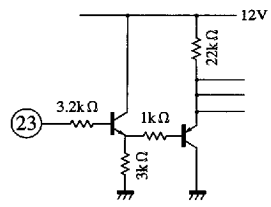
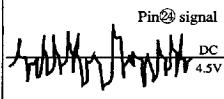
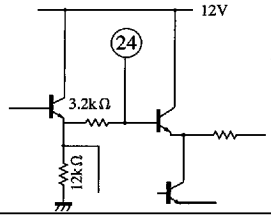
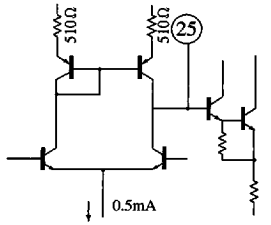
Pin No.	Pin name	Typ. waveform	Description	Equivalent circuit
18	Power supply (12V)	—	12V power pin.	—
19	PAL signal input		Signal, together with Pin 4 input, is output directly from Pin 19 to Pin 10 in case of PAL.	
20	Burst gate pulse fall setting	—	Pin for setting the falling point of internal burst-sampling pulse.	
21	Burst gate pulse rise setting	—	Pin for setting the rising point of internal burst-sampling pulse.	
22	Reference bias voltage	—	Filter pin for applying noise-free reference-voltage to the internal circuit.	
23	Pulse signal input		Pin for taking in sand-castle pulse of the AN5601K.	
24	De-emphasis		Pin for de-emphasizing a signal to which SECAM signal is demodulated in line-sequence.	
25	B-Y clamping capacitance	—	Clamping capacitance pin for regenerating DC voltage in B-Y line in which SECAM signal is demodulated in line-sequence.	
26	R-Y clamping capacitance	—	Clamping capacitor pin for regenerating DC voltage in R-Y line in which SECAM signal is demodulated in line-sequence.	

■ Pin Descriptions (cont.)

Pin No.	Pin name	Typ. waveform	Description	Equivalent circuit
27	Discriminator		Discriminator pin for SECAM demodulation. R.L.C parallel resonator is externally connected.	
28				

■ Supplementary Explanation

• Characteristic Curve

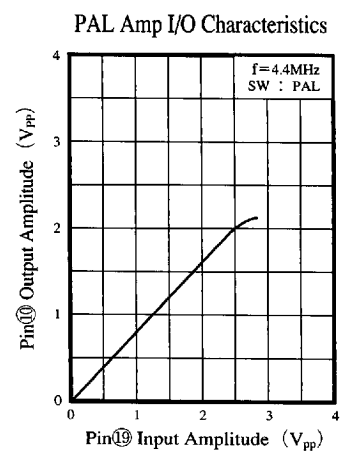
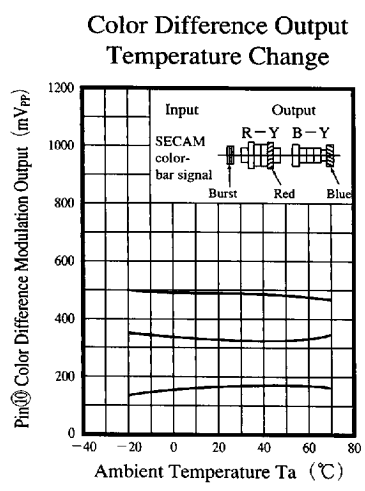
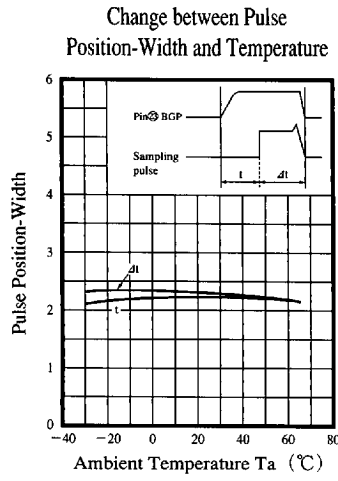
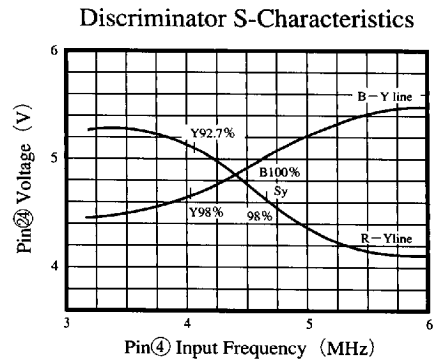
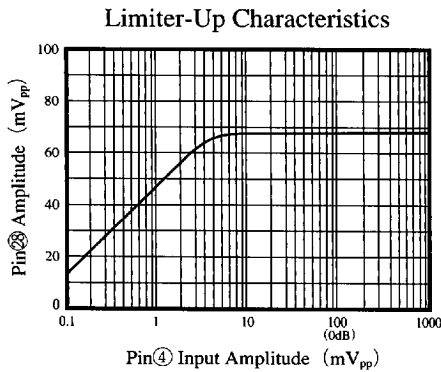

6932852 0014386 917

Panasonic

• How to Adjust the AN5633K

After adjusting the AN5601K, adjust in the following procedure:

1. Set Pins ① and ⑫ to 0V and fix the SECAM mode.

a. Adjust the discriminating transformer between Pins ⑳ and ㉑ and allow white (black) level DC to coincide.

Pin ㉑

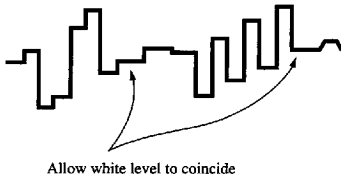

b. Adjust the resistance volume between Pins ㉓ and ㉔ and overlap the white level carrier.

Pin ⑩

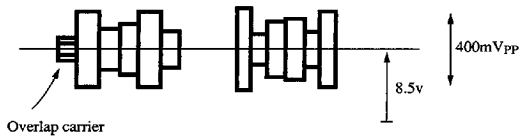

c. Adjust the input capacitance of Pin ⑥ and make the smallest amplitude of A_{cc} output Pin ⑦ of the AN5601K.

Return Pins ① and ⑫ to the Auto mode

Pin ① in Auto	SECAM color	0V	Generated automatically in the AN5633K
	Other	up to 1V	
Pin ⑫ in Auto	PAL color	1.5V or more	Get from the AN5601K
	PAL killer	0V	

6932852 0014387 853

Panasonic

This datasheet has been download from:

www.datasheetcatalog.com

Datasheets for electronics components.