

AN5606K

PAL/NTSC Video, Chrominance, and Deflection Signal Processing IC with I²C Bus Interface

■ Description

The AN5606K is an integrated circuit consisting of a Video, Chroma, and Synchronous Signal Processing (with I²C Bus) for use in the PAL/NTSC Colour TV

■ Features

- PAL/NTSC Signal Processing
- External R G B Signal Input
- Can be easily combined with SECAM Decoder IC (AN5636K)
- I²C bus control for the following 11 DAC Inputs (including Sub-level Adjusts) :
Colour, Tint (NTSC Only), Brightness, Contrast, Sharpness, H-center, RB-Drives, & RGB Cut-off
- I²C bus control for the following 8 switches : PAL/NTSC Mode Switch, 50/60Hz switch, R-Back ON/OFF, G-Back ON/OFF, B-Back ON/OFF, Blanking Switch, 3.58/4.43MHz VCO Switch
- Built-in Y-Delay (Luminance Delay), Black-Level Expander, X-Ray Protection, ACL, ABL, Colour-Killer & Spot Killer functions

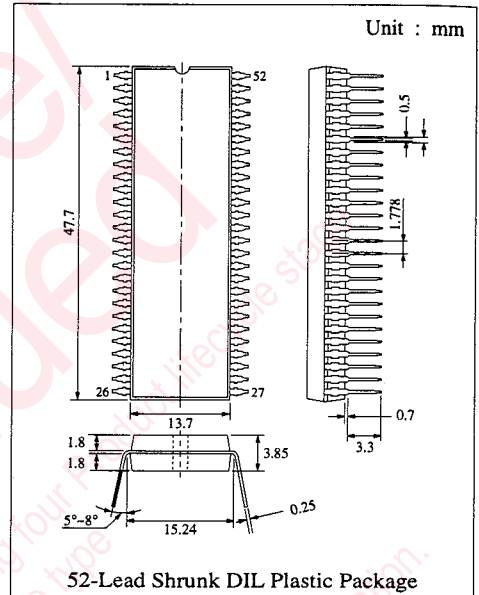

■ Block Diagram

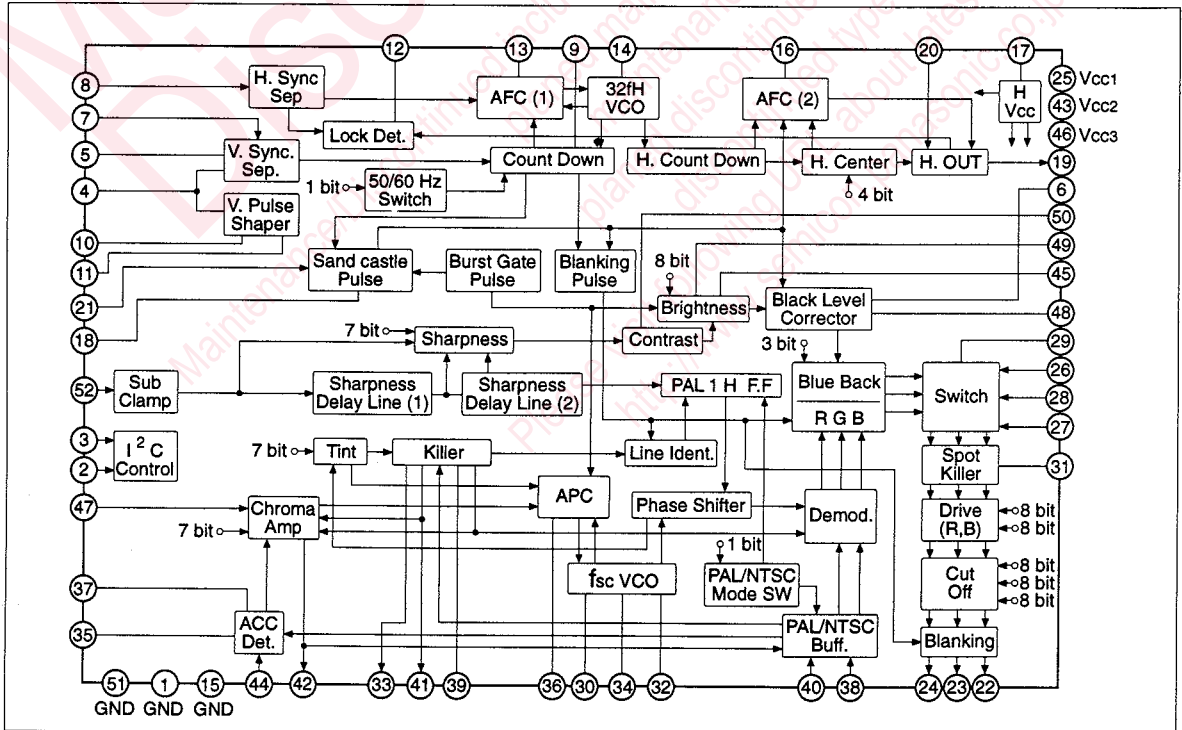

■ Absolute Maximum Ratings (Ta=25°C)

Item	Symbol	Rating			Unit
		VCC1 = 10.0	VCC2 = 5.6	VCC3 = 6.9	
Supply Voltage	VCC	VCC1 = 10.0	VCC2 = 5.6	VCC3 = 6.9	V
Supply Current	ICC	ICC1 = 75.0	ICC2 = 83.0	ICC3 = 17.0	mA
Power Dissipation (Ta = 70°C)	PD	1350			mW
Operating Ambient Temperature	Topr	-20 ~ +70			°C
Storage Temperature	Tstg	-55 ~ +150			°C

■ Recommended Operating Range (Ta=25°C)

Item	Symbol	Range
Operating Supply Voltage Range	VCC1	8.1V ~ 9.9V
Operating Supply Voltage Range	VCC2	4.5V ~ 5.5V
Operating Supply Voltage Range	VCC3	5.58V ~ 6.82V
Operating Supply Current Range	I17	13mA ~ 25mA

■ Electrical Characteristics (Ta=25°C)

Item	Symbol	Test cct	Condition	min.	typ.	max.	Unit
Circuit Current 1	ICC1	1	VCC1=9V VCC2=5V Sync, Input VCC3=6.2V	39.0	49.0	58.0	mA
Circuit Current 2	ICC2	1	VCC1=9V VCC2=5V Sync, Input VCC3=6.2V	56.0	68.0	82.0	mA
Circuit Current 3	ICC3	1	VCC1=9V VCC2=5V Sync, Input VCC3=6.2V	8.0	12.0	16.0	mA
Circuit Voltage	V17	1	I17=12mA	5.8	6.3	6.9	V
Constant Voltage Operating Resistance	R17	1	VCC1=9V, VCC2=5V, I17=12~30mA			30	Ω
Pin 47 Voltage	V47-51	1	VCC1=9V, VCC2=5V, VCC3=6.2V	1.7	2	2.3	V
Pin 52 Voltage	V52-51	1	VCC1=9V, VCC2=5V, VCC3=6.2V	2.7	3.0	3.3	V
Pin 38 Voltage	V38-51(PAL)	1	VCC1=9V VCC2=5V VCC3=6.2V (PAL MODE)	1.9	2.2	2.5	V
Pin 40 Voltage	V40-51(PAL)	1	VCC1=9V VCC2=5V VCC3=6.2V (PAL MODE)	1.9	2.2	2.5	V

I²C • DAC

Acknowledge Suction Current	V _{Ack}	1	I ₃ =2mA			0.5	V
SCL-SDA Signal Input LOW Level	V _{LOW}	1				0.5	V
SCL-SDA Signal Input HIGH Level	V _{HIGH}	1		4.5			V
Input Signal	f _{in}	1				100	k bit/s

Y-Signal Processing

Video Input Pin Voltage	V52	1	VCC1=9V VCC2=5V VCC3=6.2V I17=15mA	2.7	3.0	3.3	V
Pedestal Variation with Drive	Y _{PL-D}	1	No input, Drive : MIN/MAX Cutoff : "18", Bright : TYP	-400	0	400	mV
RGB Output Pedestal Level	Y _{PL}	1	No input, Drive : TYP Cutoff : "18", Bright : TYP	1.5	2.1	2.47	V
Video Voltage Gain	A _V	1	Input 0.4V _{pp} , Contrast : TYP Sharpness : MIN, Brightness : TYP	5.1	6.3	7.5	Times
Video Frequency Characteristics	f _{YC}	1	Attenuation at input f=6MHz to output level at input f=2MHz	-7	-3		dB
Black Level Variable with Aperture Control Change	Y _{PL-S}	1	No Input, Pedestal measurement Sharpness = MAX/MIN	-50		50	mV
Contrast Ratio	e _{MAX} , e _{MIN}	1	Input Sinewave 0.4V _{pp} , f=2MHz, Contrast=MAX/MIN	15	18	21	dB
RGB Output Tracking	e _{OT}	1	Contrast=10→70	7	10	13	dB
Brightness Variable Range	B	1	Input 0.4V _{pp} , Brightness=MIN-MAX, Measure pedestal level	2.3	2.8	3.3	V

■ Electrical Characteristics (Ta=25°C) (Continue)

Item	Symbol	Test cct	Condition	min.	typ.	max.	Unit
Brightness Control Sensitivity	B _G	1	Brightness = 5F → 9F	0.55	0.85	1.15	V
DC Restoration Rate	T _{DC}	1	Input 0.4Vpp, Contrast=MAX, Sharpness:MIN, APL 10 ~ 90%	91	95	105	%
RGB Output BLK Level	Y _{BL}	1	Vcc1=9V, Vcc2=5V, H, VBLK level when Vcc3=6.2V, I17=15mA	0.5	1.0	1.5	V
Black Level Correction							
Correction Quantity (Amplitude Var.)	V _{BL} (a)-(b)	1	Input Signal : All Black (a) Pin 48 : External RC (b) Pin 48 : 9V	100	100	100	mV
Y-signal Delay Time	τ _D	1	Input Stair step 0.4Vpp	120	180	240	nsec
ACL Characteristic	ACL	1	Input Stair step Pin 50 = 3.0~4.3V	6.5	8.5	10.5	dB/V
ABL Characteristic	ABL	1	Pedestal level variation with Pin 49 = 3.0~3.4V	0.9	1.4	1.9	V/V
ON Screen Circuit							
Ys Threshold	e _{STH}	1	Switch level of Pin 26	0.55	0.7	0.85	V
External RGB Freq. Characteristic	e _{fRGB}	1	Input Sinewave 0.2Vpp, Ys=1V, f=2MHz ~ 10MHz	-2	0	2	dB
External RGB Output DC Voltage	EOEXT	1	Input/No input Ys=1V Cutoff="18", Measure B	1.2	1.9	2.7	V
Int./Ext. Pedestal Difference Voltage	EOYS	1	Measure pedestal level difference at Ys=0.4(OFF)/1.2V(ON)	0	200	350	mV
External RGB Output Signal Level	EEXT	1	Input Sinewave 0.2Vpp f=2MHz, Contrast=MAX, Measure B	4.6	6.6	8.6	dB
Internal/External Crosstalk	ECT	1	Input Sinewave Ys=0.4Vpp, f=10MHz (1Vpp), External/Internal crosstalk			-50	dB
External RGB Output Blanking Voltage	YBLK (RGB)	1	No input when Vcc1=9V, Vcc2=5V Vcc3=6.2V, I17=15mA	0.5	1.0	1.5	V
External RGB Contrast Control Characteristic	EEXT-C	1	Input 2Vpp, Output ratio when Contrast=MAX/MIN	8.4	11.4	14.4	dB
Colour Signal Processing Circuit							
PAL Colour Difference Output (B-Y)	e _O	1	Colour Bar signal, Burst 150mVpp Contrast=Colour=TYP	2.08	2.60	3.12	Vpp
PAL ACC Characteristic	ACC	1	Colour Bar Signal, Burst 300mVpp (+6dB)	0.8	1.0	1.2	Times
PAL Demodulation Output Ratio (1)	R/B	1	Colour Bar Signal, Burst 150mVpp Contrast=Colour=TYP	0.72	0.83	0.90	Times
PAL Demodulation Output Ratio (2)	G/B	1	Colour Bar Signal, Burst 150mVpp Contrast=Colour=TYP	0.31	0.37	0.42	Times
PAL Demodulation Angle R	∠R	1	Colour Bar Signal, Burst 150mVpp Contrast=Colour=TYP	84	90	96	deg
PAL Demodulation Angle G	∠G	1	Colour Bar Signal, Burst 150mVpp Contrast=Colour=TYP	229	237	244	deg
PAL Demodulation Output Residual Carrier	e _{car}	1	No signal input, 4.43MHz component of each output pin			90	mVpp
Colour Difference Output Contrast Ratio	Δe _{OC}	1	Colour Bar Signal, Burst 150mVpp, Contrast = MIN→MAX, Colour = TYP	15	18	21	dB
NTSC Tint Center	T _C	1	Colour Bar Signal, Burst 150mVpp, Measure phase displacement at Tint data 37	-7	0	+7	deg
NTSC Tint Variable Range	Δθ _T	1	Colour Bar Signal, Burst 150mVpp, Measure phase displacement at Tint = MIN ~ MAX	70	90	120	deg
PAL Colour Variable Range	Δe _{O-COL}	1	Colour Bar Signal, Burst 150mVpp, Contrast=TYP, Colour=Variation at 10→7F	17	19	23	dB
PAL APC Pull-in Range	f _{PCP}	1	Burst frequency is variable	±450	±500		Hz
NTSC APC Pull-in Range	f _{PCN}	1	Burst frequency is variable	±450	±500		Hz
PAL VCO Free-run Frequency	f _{COP}	1	No Signal Acc = OFF	-150	0	+150	Hz
NTSC VCO Free-run Frequency	f _{CON}	1	No Signal Acc = OFF	-150	0	+150	Hz
PAL VCO Output Level	e _{CW-P}	1	Pin 30 output level when Vcc1=9V, Vcc2=5V, Vcc3=6.2V, I17=15mA	0.3	0.4	0.5	Vpp
NTSC VCO Output Level	e _{CW-N}	1	Pin 30 output level when Vcc1=9V, Vcc2=5V, Vcc3=6.2V, I17=15mA	0.3	0.4	0.5	Vpp

■ Electrical Characteristics (Ta=25°C) (Continue)

Item	Symbol	Test cct	Condition	min.	typ.	max.	Unit
PAL Colour Killer Tolerance	e _{KP}	1	Colour Bar Signal, Burst 150mV _{pp} =0dB, Colour=Contrast=MAX	-30	-36	-41	dB
NTSC Colour Killer Tolerance	e _{KN}	1	Colour Bar Signal, Burst 150mV _{pp} =0dB, Colour=Contrast=MAX	-37	-41	-46	dB
PAL/SECAM Changeover Voltage	V _{47-P/S}	1	Pin 47 PAL/SECAM changeover threshold	2.35	2.5	2.65	V
RGB Output Circuit							
Drive Adjustment Range	A _{VD}	1	External input 0.2V _{pp} input, Y _s =1V, Drive: MIN-MAX, R, B output	3	6	9	dB
Cutoff Adjustment Range	V _{CUT}	1	No input, Pedestal level variation with cutoff:MIN-MAX	1.0	1.3	1.6	V
Deflection Signal Processing							
Horizontal Free-run Osc. Frequency	f _{HO}	1	No input Pin 19 output frequency	15.45	15.75	16.05	kHz
Horizontal Free-run Osc. Frequency Dependency with Supply Voltage	$\frac{\Delta f_{HO}}{V_{CC3}}$	1	f _{HO} (I ₁₇ =30mA), f _{HO} (I ₁₇ =15mA)	-100	0	100	Hz
Hor. Oscillation Starting Voltage	V _{fH(S)}	1	Horizontal osc. output is 1V _{pp} or more and f=10k-20kHz			5.2	V
Hor. Oscillation Pulse Duty Ratio	T _{HO}	1	I ₁₇ =15mA, V _{cc1} =9V V _{cc2} =5V, V _{cc3} =6.2V	35.0	38.0	41.0	%
Hor. Pull-in Range	f _{PH}	1	f _{HO} =15.75kHz	±400			Hz
Hor. Pulse Output Voltage	V ₁₉	1	V _{cc} =TYP	2.3	2.8	3.3	V
High-tension Detection Circuit Operating Voltage (Shutdown)	V _{sth}	1	I ₂₀ =50μA	0.63	0.68	0.73	V
Shutdown Leakage Current	I _{sth}	1	Measure I ₂₀ when Pin 20=0V			5.0	μA
Vertical Signal Processing							
PAL Vertical Free-run Osc. Frequency	f _{VO-P}	1	$(\frac{2}{625} f_{H-P})$	48.5	50	51.5	Hz
NTSC Vertical Free-run Osc. Freq.	f _{VO-N}	1	$(\frac{2}{525} f_{H-N})$	58.5	60	61.5	Hz
Vertical Free-run Osc. Pulse Width	T _{VO}	1	PAL : f _H =15.625kHz NTSC : f _H =15.75kHz	9.5	10.0	10.5	1/f _H
PAL Vertical Pull-in Enable Freq.	f _{PV-P}	1	f _{V-P} =50Hz	45	50	55	Hz
NTSC Vertical Pull-in Enable Freq.	f _{PV-N}	1	f _{V-N} =60Hz	55	60	65	Hz
Vout Output Voltage	V ₉	1	I ₁₇ =15mA, V _{cc1} =9V V _{cc2} =5V, V _{cc3} =6.2V	0	0.2	0.5	V
Ver. Pulse Shaper Output Pulse Width	T ₁₀	1		1.4	2.2	3.0	msec
Sandcastle Pulse							
PAL Burst Gate Pulse Width	T _{BGP-P}	1	Pin 18 PAL Burst gate pulse width	3.4	4.0	4.6	μsec
NTSC Burst Gate Pulse Width	T _{BGP-N}	1	Pin 18 NTSC Burst gate pulse width	2.5	3.0	3.5	μsec
PAL V-Blanking Width	T _P VBLK	1	Pin 18 PAL blanking pulse width (21±1)H	1.28	1.34	1.41	msec
NTSC V-Blanking Width	T _N VBLK	1	Pin 18 NTSC blanking pulse width (17±1)H	1.01	1.08	1.14	msec
Burst Gate Pulse Output Voltage	V _{BGP}	1	I ₁₇ =15mA, V _{cc1} =9V V _{cc2} =5V, V _{cc3} =6.2V	3.7	4.1	4.6	V
H-Blanking Pulse Output Voltage	V _{HBLK}	1	I ₁₇ =15mA, V _{cc1} =9V V _{cc2} =5V, V _{cc3} =6.2V	2.5	2.9	3.4	V
V-Blanking Pulse Output Voltage	V _{VBLK}	1	I ₁₇ =15mA, V _{cc1} =9V V _{cc2} =5V, V _{cc3} =6.2V	1.0	1.5	2.0	V
H Center Circuit							
H Center Variable Range (1)	T _{DH(1)}	1	H center : TYP→MIN H _{sync} rise and HBLK delay	-2.2	-1.6	-1.3	μsec
H Center Variable Range (2)	T _{DH(2)}	1	H center : TYP→MAX H _{sync} rise and HBLK delay	1.3	1.6	2.2	μsec
Lock Detector Circuit							
Lock Detector Output Voltage (Hi)	V _{12-Hi}	1	In Hor. Loop ON state, Pin 12 voltage at input of Hor. sync. signal	7.9	8.5	9.0	V
Lock Detector Output Voltage (Lo)	V _{12-Lo}	1	In Hor. Loop On state, Pin 12 voltage at no input		0.2	0.5	V

■ Electrical Characteristics (Ta=25°C) (Continue)

Item	Symbol	Test cct	Condition	min.	typ.	max.	Unit
Service Switch Circuit							
Service Switch Threshold	V _{sth}	1		0.35	0.65	1.10	V
Service SW Operation	e _{ser}	1	Input : Stair step 0.4Vpp, Measure amplitude at Pin 50 (SCL)=00			150	mVpp
Spot Killer							
Spot Killer Operation	K _{SP}	1	Measure each output pedestal level when the current of 1mA is applied to Pin 31	6.8	7.5	8.2	V

■ Characteristics Curve Diagrams

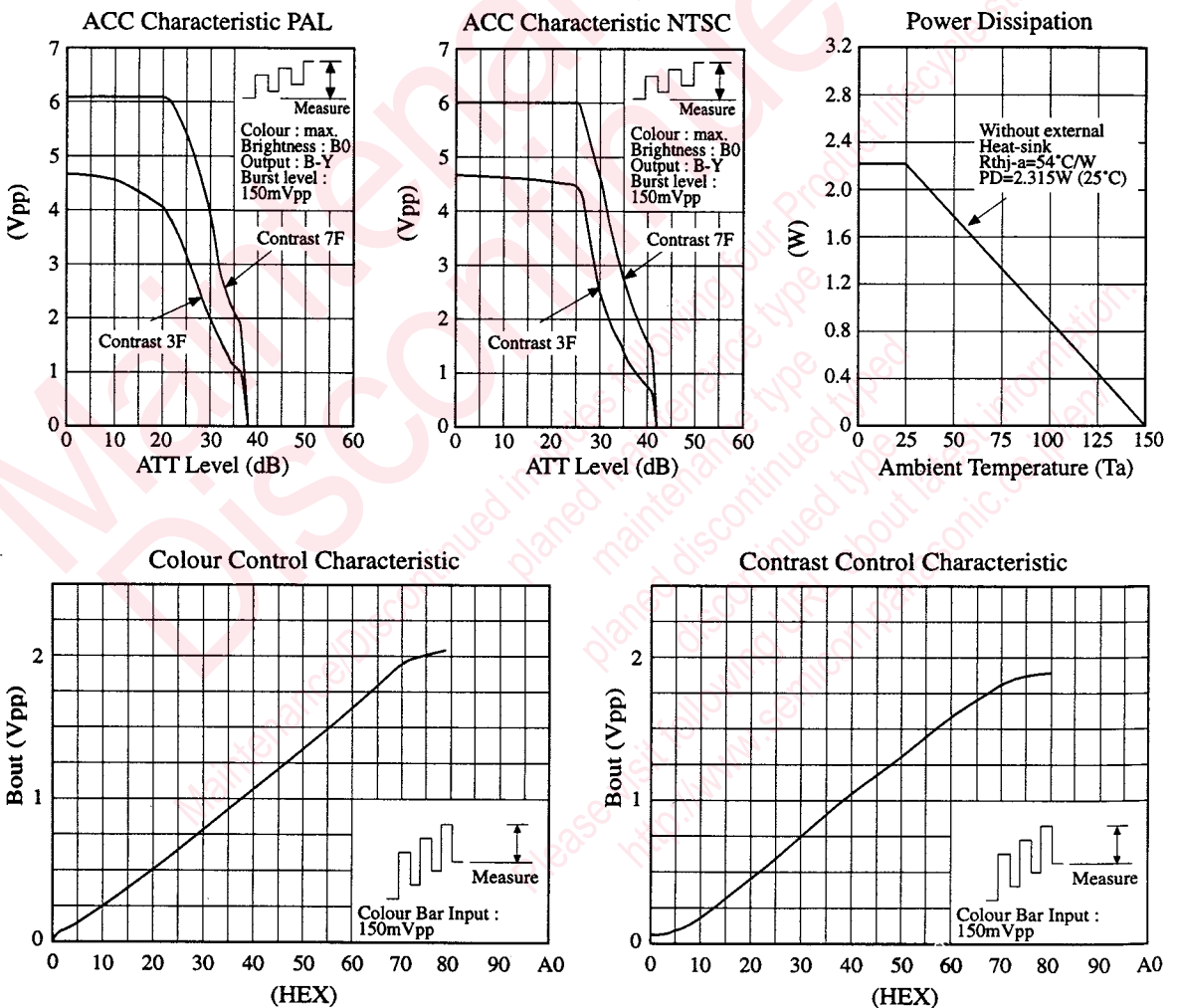

● Characteristics Curve Diagrams (Continue)

ABL Characteristic

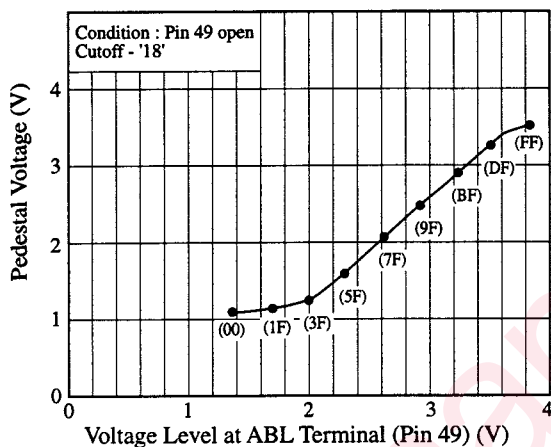

ACL Characteristic

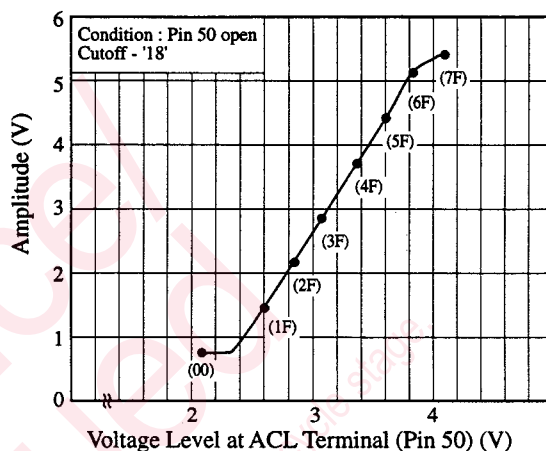

Video Frequency Characteristic

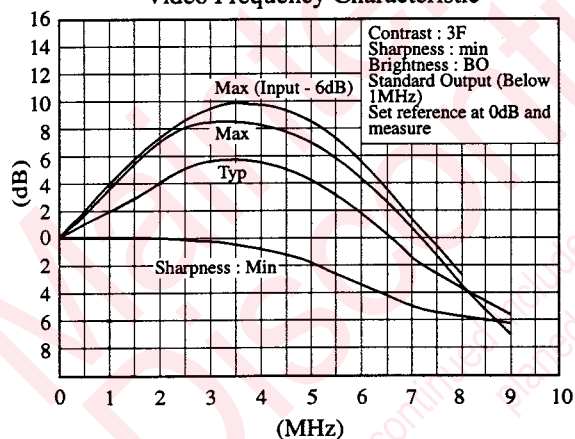

Brightness Control Characteristic

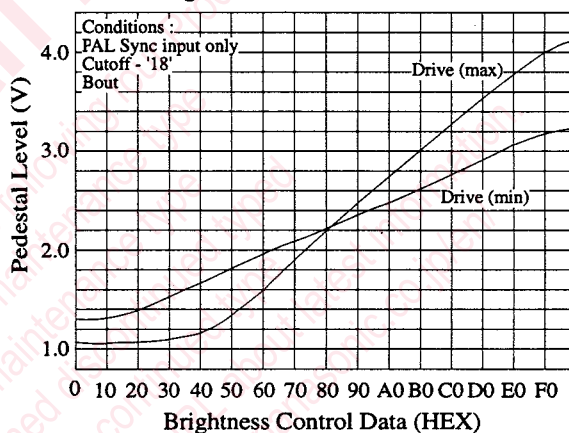

Black Level Correction Characteristic

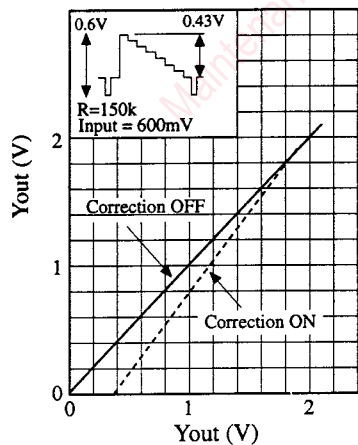

β Curve NTSC

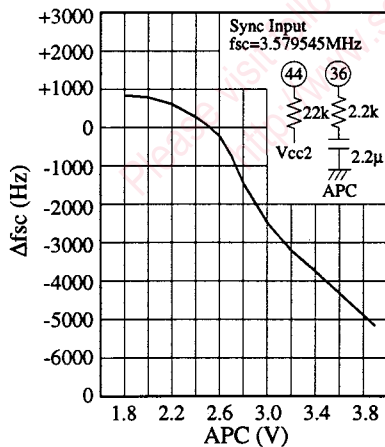

β Curve PAL

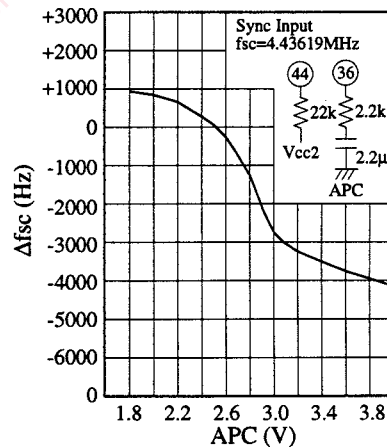

■ Pin Descriptions

Pin No.	Pin Name	Pin No.	Pin Name
1	GND (I ² C)	27	B input
2	SCL input	28	G input
3	SDA input	29	R input
4	Vertical integration filter	30	CW output
5	Vertical sync. separation input	31	Spot Killer input
6	Black level correction starting point adjustment	32	3.58MHz oscillation
7	Vertical sync. input	33	Killer bypass
8	Horizontal sync. input	34	4.43MHz oscillation
9	Vertical output	35	ACC filter 1
10	50/60Hz pulse output	36	APC filter
11	50/60Hz shaper	37	ACC filter 2
12	Horizontal sync. detection filter	38	R-Y input
13	Horizontal AFC 1 filter	39	Killer filter
14	503kHz (32fH) oscillation	40	B-Y input
15	GND (Vertical)	41	Killer output
16	Horizontal AFC 2 filter	42	Chroma signal output
17	Supply voltage 4 (Horizontal)	43	Supply voltage 2 (Chroma)
18	Sandcastle pulse output	44	ACC detection filter
19	Horizontal drive pulse output	45	Y Clamp capacitor
20	High tension detection (shutdown) input	46	Supply voltage 3 (Video)
21	Flyback pulse input	47	Chroma signal input
22	B output	48	Black level detection filter
23	G output	49	Automatic brightness limiter, ABL
24	R output	50	Automatic contrast limiter, ACL
25	Supply voltage 1 (Video/RGB output)	51	GND (Video/Chroma)
26	Ys input	52	Video signal input

Test Circuit 1

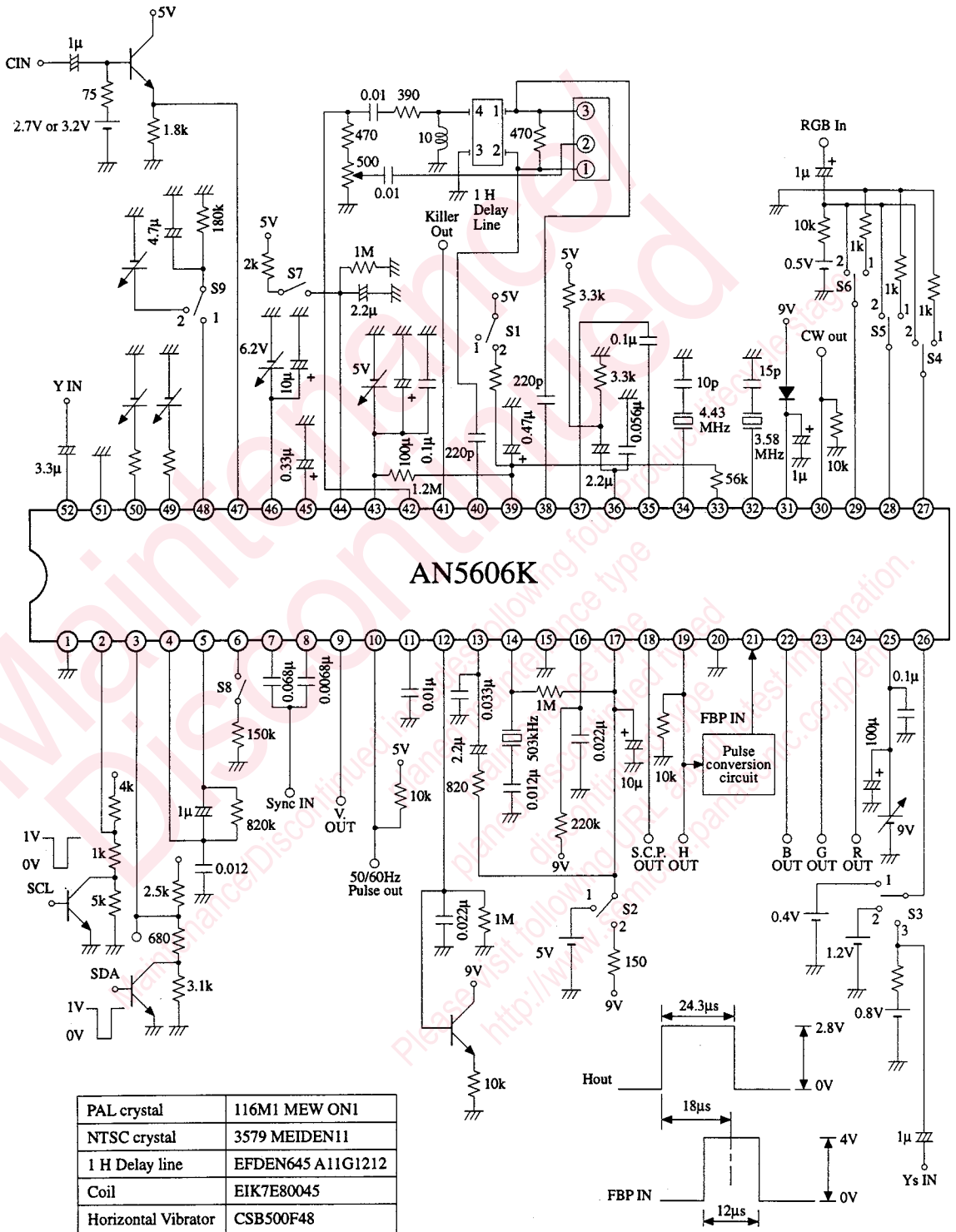

● I²C Bus protocol (1)

I²C Bus Formats

(1) Slave address :

1 0 0 0 1 0 1 0

(2) Slave address format :

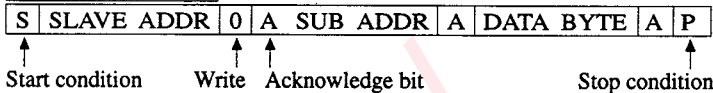

(3) Subaddress byte and data byte format :

Sub-addr (H)	Functions	Data Byte								Initial Setting at Power ON
		D7	D6	D5	D4	D3	D2	D1	D0	
00	Colour	0	A06	A05	A04	A03	A02	A01	A00	3F (TYP)
01	Tint	0	A16	A15	A14	A13	A12	A11	A10	3F (TYP)
02	Brightness	A27	A26	A25	A24	A23	A22	A21	A20	7F (TYP)
03	Contrast	0	A36	A35	A34	A33	A32	A31	A30	3F (TYP)
04	Sharpness	0	A46	A45	A44	A43	A42	A41	A40	3F (TYP)
05	Cutoff R	A57	A56	A55	A54	A53	A52	A51	A50	7F (TYP)
06	Cutoff G	A67	A66	A65	A64	A63	A62	A61	A60	7F (TYP)
07	Cutoff B	A77	A76	A75	A74	A73	A72	A71	A70	7F (TYP)
08	Drive R	A87	A86	A85	A84	A83	A82	A81	A80	7F (TYP)
09	Drive B	A97	A96	A95	A94	A93	A92	A91	A90	7F (TYP)
0A	H Center	0	0	0	0	AA3	AA2	AA1	AA0	08 (TYP)
0B	MODE SW (PAL/NTSC)								PNS	Refer to I ² C Bus protocol (2)
0B	50/60Hz SW								VFS	Refer to I ² C Bus protocol (2)
0B	RGB Back MODE								RGB	Refer to I ² C Bus protocol (2)
0B	RGB Back								R G B	Refer to I ² C Bus protocol (2)
0B	Blanking SW	BLK								Refer to I ² C Bus protocol (2)
0B	VCO SW	VCO								Refer to I ² C Bus protocol (2)

● I²C Bus protocol (1)

Data byte Condition at Sub-addr. (0BH)





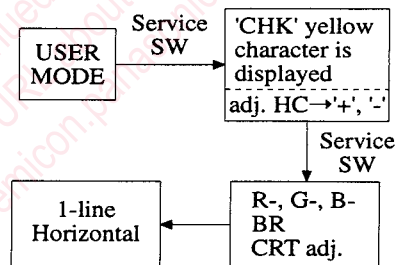



Functions	Data (* mark shows SW ON)	Condition
Mode SW	PNS	*1 PAL
		0 NTSC
50/60Hz	VFS	*0 50Hz
		1 60Hz
RGB Back MODE	RGB	1 Without Vsync. Lock
		*0 With Vsync. Lock
RGB Back	B	1 ON
		*0 OFF
	G	1 ON
		*0 OFF
	R	1 ON
		*0 OFF
Blanking SW	BLK	1 Without Blanking
		*0 With Blanking
VCO SW	VCO	1 3.58MHz
		*0 4.43MHz

● For TV set (Service mode)

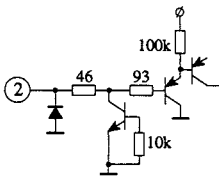

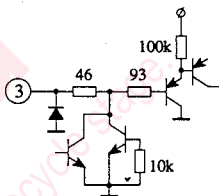
Press 'NORM' twice to go back to user mode.

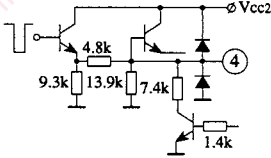

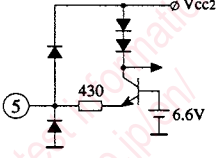
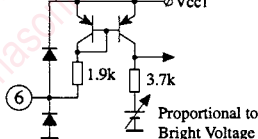
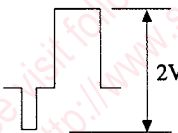
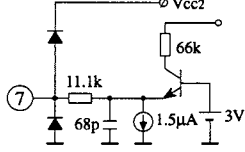
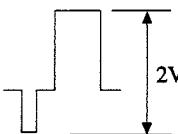
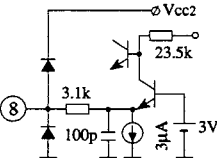
Pin Descriptions

Pin No.	Pin Name	Pin Description	Typical Waveform	I/O IMP.	Equivalent Circuit
1	GND	GND for DAC and I ² C		0	
2	I ² C SCL input	Pin for connection to MICOM (High Impedance connection)		∞	
3	I ² C SDA input	Pin for connection to MICOM (High Impedance connection)		∞	
4	V Sync. Sep Integration filter	V. Sync-signal integration filter (LPF) pin. Negative-polarity composite sync-signal is output from the V. sync-sep. circuit. DC 8.3V		3.6kΩ	
5	V Sync. Sep Input	V. sync-signal input pin. From the integration filter is obtained the V. sync-signal which is then input to the IC at this pin for sync. DC 5.9V		430Ω	
6	Black Level Correction Start Point	Black Level correction circuit. Start-point adjustment pin. R is connected between this pin and GND	DC	1.9kΩ	
7	Sync. in (V)	Input pin for Sync. Sep. DC = 2.3V 2V ±3dB D-range 3.3V Composite input		11.1kΩ	
8	Sync. in (H)	Input pin for Sync. Sep. DC = 2.3V 2V ±3dB D-range 3.3V Composite input		3.1kΩ	





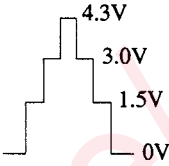
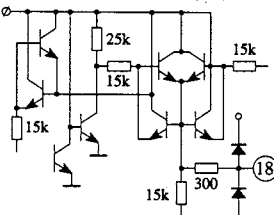
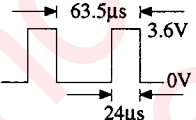
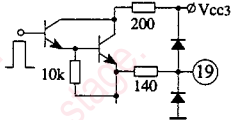
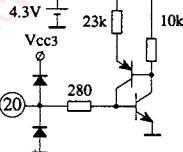
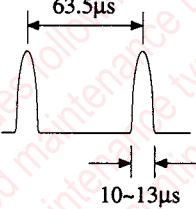
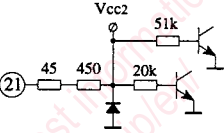
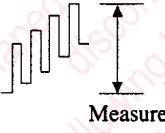
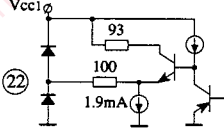
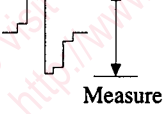
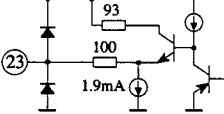
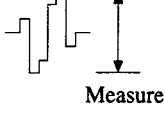
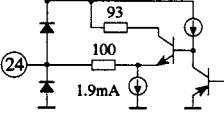

■ Pin Descriptions (Continue)

Pin No.	Pin Name	Pin Description	Typical Waveform	I/O IMP.	Equivalent Circuit
9	Vout	Output pin for vertical osc. pulse signal. Hi : 4.3V Lo : 0V (Can connect to AN5534)		100Ω	
10	V Pulse Shaper Output	For 50/60Hz discrimination by the MICOM. This circuit is used to stretch the V pulse Collector Output : Hi : 5.0V Lo : 0.2 (sat)V MICOM Connection		Open Collector	
11	V Pulse Shaper Condenser	Pin for connecting V-pulse shaper condenser		100kΩ	
12	Lock Det. Filter	Filter Pin for detection of sync. between H osc. and input sync. RC filter is connected to this pin Hi : 8.3V Lo : 0.2 (sat)V, MICOM connection		10kΩ	
13	AFC1 Filter	H. AFC current output pin. The RC filter connected to this pin cause the H AFC to operate Freq. adjustment Hi : Freq. is low Lo : Freq. is high		27kΩ	
14	503kHz Vcc	H. osc. pin. Oscillations by connection of 503kHz resonator at this pin. DC 2.2V		280	
15	GND2	GND for sync-circuits		0	
16	AFC2 Filter	Filter pin for phase detection in the adjustment of the position of the picture Phase Adjustment : Hi : Phase Lead Lo : Phase Lag		∞	
17	H Vcc	Vcc pin for the sync-circuit Vcc = 6.3V	DC	0	

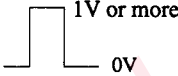
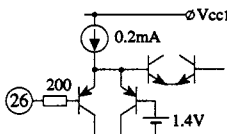
■ Pin Descriptions (Continue)

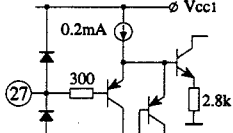
Pin No.	Pin Name	Pin Description	Typical Waveform	I/O IMP.	Equivalent Circuit
18	Sand castle pulse output	Pin for producing the layered pulse that consists of the V, H, blanking and burst-gate pulse for synchronisation of AN5606K with other ICs Threshold Voltage Burst Gate Pulse 3.6V H. Blanking Pulse : 2.2V V. Blanking Pulse : 0.8V		300	
19	Horizontal drive pulse output	Horizontal drive pulse output. Emitter output : Hi : (5V-2D) Lo : 0V		140	
20	High voltage detection input (shut down input)	Pin for shutdown input When 0.6-0.8V or more is input, then shutdown occur and the H. output signal is cut off If shutdown is not used, then connect this pin to ground	DC	∞	
21	Horizontal blanking pulse input	H. Blanking pulse input pin. Blanking pulse is used not only for clamp-generation circuit, but also for Colour blanking, Y-blanking, Black-level correction circuits, and Picture Position Control H. Blanking Pulse : Threshold Voltage 0.7V AFC2 pulse : Threshold voltage 2.0V		∞	
22	B Output	B Output pin		100Ω	
23	G Output	G Output pin		100Ω	
24	R Output	R Output pin		100Ω	
25	Vcc1	Video, Chroma Vcc pin Typ. 9V		0	

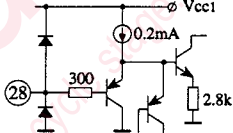
■ Pin Descriptions (Continue)

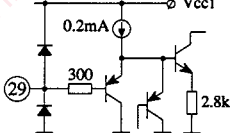
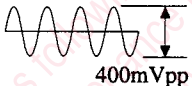
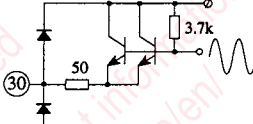
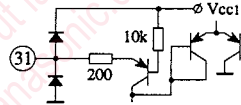
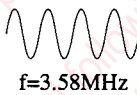
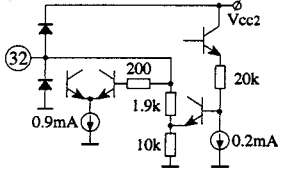
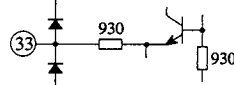
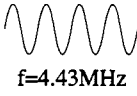
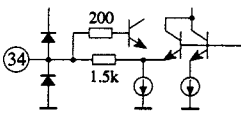
Pin No.	Pin Name	Pin Description	Typical Waveform	I/O IMP	Equivalent Circuit
26	Ys Input	Input pin for switching pulse to switch between internal signal and external RGB signal		∞	
27	External B Input	External B input pin DC coupling		∞	
28	External G Input	External G input pin DC coupling		∞	
29	External R Input	External R input pin DC coupling		∞	
30	CW Out	Carrier output pin for processing the Chroma signal of AN5606K. By means of VCO switch-over, the output freq. is changed 3.579545 MHz, 4.433619 MHz		50Ω	
31	Spot-Killer	Pin for necessarily fast discharge of the residual voltage at the CRT Diode, Transistor, Condenser are connected	Vcc = 9V-VBE Operating	Open Emit-ter	
32	3.58MHz Oscillation	Chroma 3.58MHz Osc. pin. Externally connected crystal-resonator and capacitor. DC 2.2V (ON), DC 3.5V (OFF)		1.9kΩ	
33	Killer-Bias	Standard bias voltage output for the killer-circuit	DC	930Ω	
34	4.43 MHz Oscillation	Chroma 4.43MHz Osc. pin. Ext. connected crystal-resonator and condenser. DC 2.2V (ON), DC 3.5V (OFF)		1.5kΩ	

■ Pin Descriptions (Continue)

Pin No.	Pin Name	Pin Description	Typical Waveform	I/O IMP.	Equivalent Circuit
35	ACC Filter 1	Chroma ACC circuit noise-removal filter pin	DC	12.7k Ω	
36	Chroma Phase Detection Filter Pin	Phase detection filter pin for chroma-osc. frequency DC 2.5V	DC	46.3k Ω	
37	ACC Filter 2	Chroma ACC circuit noise-removal filter pin	DC	12.7k Ω	
38	R-Y Input	PAL Chroma (R-Y) input pin DC 2.2V in the burst signal for every 1H interval, the carrier phase is inverted		10.1k Ω	
39	Killer Filter	Killer-detection filter pin	DC	∞	
40	B-Y Input	PAL Chroma (B-Y) input pin DC 2.2V In the burst signal, for every 1H interval, the carrier phase is inverted		10.1k Ω	
41	Killer detection output	Killer ON/OFF output Hi : 5.0V (Burst present) Lo : 0.2V (sat)	DC	30.1k Ω	
42	Chroma output	Output pin for ACC-adjusted chroma signal DC 4.2V		50 Ω	
43	Vcc2	Video, Chroma Vcc pin for circuit Typ 5.0V	DC	0	
44	ACC Detection filter	ACC detection filter pin Between Vcc2 and this pin is connected the RC in parallel	DC	∞	

■ Pin Descriptions (Continue)

Pin No.	Pin Name	Pin Description	Typical Waveform	I/O IMP.	Equivalent Circuit
45	Y Clamp Condenser	Y clamp-condenser pin DC 1.5V (Center)	DC	∞	
46	Vcc3	Vcc pin for video circuit Typ. 6.2V	DC	0	
47	Chroma Signal Input	External Chroma Input pin Burst signal typ 150mVpp, 330mVpp ± 3 dB D-range 1.0V DC input to switch between PAL/SECAM : PAL 2.0V, SECAM 3.0V, Open DC 2.0V		10kΩ	
48	Black Level Detection Filter	Black Level Detection pin	DC	2.8kΩ	
49	Brightness Control Automatic Brightness Limiter (ABL)	Brightness control pin for automatic control of Brightness of the CRT 1.4V/V Variable range 3V DC 3.0V	DC	7.5kΩ	
50	Contrast Control (ACL) Automatic Contrast Limiter	Contrast control pin for automatic control of the CRT contrast. 2~4V positive polarity ACL DC 3.0V	DC	7.0kΩ	
51	GND	GND for Video/Chroma/RGB	DC	0	
52	Video Signal Input	Video signal input pin		0	

Request for your special attention and precautions in using the technical information and semiconductors described in this book

- (1) If any of the products or technical information described in this book is to be exported or provided to non-residents, the laws and regulations of the exporting country, especially, those with regard to security export control, must be observed.
- (2) The technical information described in this book is intended only to show the main characteristics and application circuit examples of the products. No license is granted in and to any intellectual property right or other right owned by Panasonic Corporation or any other company. Therefore, no responsibility is assumed by our company as to the infringement upon any such right owned by any other company which may arise as a result of the use of technical information described in this book.
- (3) The products described in this book are intended to be used for standard applications or general electronic equipment (such as office equipment, communications equipment, measuring instruments and household appliances).
Consult our sales staff in advance for information on the following applications:
 - Special applications (such as for airplanes, aerospace, automobiles, traffic control equipment, combustion equipment, life support systems and safety devices) in which exceptional quality and reliability are required, or if the failure or malfunction of the products may directly jeopardize life or harm the human body.
 - Any applications other than the standard applications intended.
- (4) The products and product specifications described in this book are subject to change without notice for modification and/or improvement. At the final stage of your design, purchasing, or use of the products, therefore, ask for the most up-to-date Product Standards in advance to make sure that the latest specifications satisfy your requirements.
- (5) When designing your equipment, comply with the range of absolute maximum rating and the guaranteed operating conditions (operating power supply voltage and operating environment etc.). Especially, please be careful not to exceed the range of absolute maximum rating on the transient state, such as power-on, power-off and mode-switching. Otherwise, we will not be liable for any defect which may arise later in your equipment.
 - Even when the products are used within the guaranteed values, take into the consideration of incidence of break down and failure mode, possible to occur to semiconductor products. Measures on the systems such as redundant design, arresting the spread of fire or preventing glitch are recommended in order to prevent physical injury, fire, social damages, for example, by using the products.
- (6) Comply with the instructions for use in order to prevent breakdown and characteristics change due to external factors (ESD, EOS, thermal stress and mechanical stress) at the time of handling, mounting or at customer's process. When using products for which damp-proof packing is required, satisfy the conditions, such as shelf life and the elapsed time since first opening the packages.
- (7) This book may be not reprinted or reproduced whether wholly or partially, without the prior written permission of our company.

This datasheet has been downloaded from:

www.DatasheetCatalog.com

Datasheets for electronic components.