

# HA13119

T-74-05-01

## Dual 5.5 W Audio Power Amplifier

The HA13119 is power IC designed for car radio and car stereo amplifiers. At 13.2 V to 4  $\Omega$  load, this power IC provides output power of 5.5 W with 10 % distortion.

It is easy to design as this IC employs internal each protection circuit and the new small package.

### Features

- Low distortion
  - THD = 0.1 % typ  
( $P_o = 0.5$  W,  $f = 100$  Hz to 10 kHz)
  - THD = 1 % typ  
( $P_o = 3$  W,  $f = 70$  Hz to 40 kHz)
- Internal each protection circuits
  - Surge protection circuit (more than 50 V)
  - Thermal shut-down circuit
  - Ground fault protection circuit
  - Power supply fault protection circuit
- Low external components count

**Table 1 Absolute Maximum Ratings (Ta = 25 °C)**

Item	Symbol	Rating	Unit	Note
Operating supply voltage	Vcc	18	V	
DC supply voltage	Vcc (DC)	26	V	1
Peak supply voltage	Vcc (peak)	50	V	2
Output current	Io (peak)	4	A	3
Power dissipation	Pr	15	W	4
Thermal resistance	$\theta_{j-c}$	3.5	°C/W	
Junction temperature	Tj	150	°C	
Operating temperature	Topr	-30 to +80	°C	
Storage temperature	Tstg	-55 to +125	°C	

- Notes: 1. Value at  $t = 30$  sec.  
 2. Value at width  $t_w = 200$  ms and rise time  $t_r = 1$  ms.  
 3. Per channel  
 4. Per package

### Ordering Information

Type No.	Package
HA13119	SP-15T



Hitachi America, Ltd. • Hitachi Plaza • 2000 Sierra Point Pkwy. • Brisbane, CA 94005-1819 • (415) 589-8300

353

HA13119

T-74-05-01

Table 2 Electrical Characteristics (V<sub>CC</sub> = 13.2 V, f = 1 kHz, R<sub>L</sub> = 4 Ω, T<sub>a</sub> = 25 °C)

1 channel operation

Item	Symbol	Min	Typ	Max	Unit	Test conditions
Quiescent current	I <sub>Q</sub>	—	80	160	mA	V <sub>in</sub> = 0 V
Input bias voltage	V <sub>B</sub>	—	—	10	mV	V <sub>in</sub> = 0 V, R <sub>g</sub> = 10 kΩ
Voltage gain	G <sub>v</sub>	48	50	52	dB	V <sub>in</sub> = -50 dBm
Voltage gain difference	ΔG <sub>v</sub>	—	—	+1.5	dB	V <sub>in</sub> = -50 dBm
Output power	P <sub>out</sub>	5.0	5.5	—	W	R <sub>L</sub> = 4 Ω V <sub>CC</sub> =13.2 V THD = 10 % V <sub>CC</sub> =14.4 V
Total harmonic distortion	THD	—	0.05	0.5	%	P <sub>out</sub> = 1.5 W
Wide band noise	WBN	—	0.6	1.2	mV	R <sub>g</sub> = 10 kΩ, BW = 20 Hz to 20 kHz
Supply voltage rejection ratio	SVR	35	50	—	dB	R <sub>g</sub> = 600 Ω, f = 500 Hz
Input impedance	R <sub>in</sub>	—	33	—	kΩ	f = 1 kHz, V <sub>in</sub> = -50 dBm
Roll off frequency	f <sub>L</sub>	—	55	—	Hz	ΔG <sub>v</sub> = -3 dB Low from
	f <sub>H</sub>	—	50	—	kHz	f = 1 kHz Ref High
Cross-talk	C.T	40	55	—	dB	R <sub>g</sub> = 600 Ω, V <sub>in</sub> = -50 dBm

2 channel operation

Item	Symbol	Min	Typ	Max	Unit	Test conditions
Output power	P <sub>out</sub>	—	5.3	—	W	THD = 10 %
Total harmonic distortion	THD	—	0.10	—	%	P <sub>out</sub> = 1.5 W



Typical Application Circuit

T-74-05-01

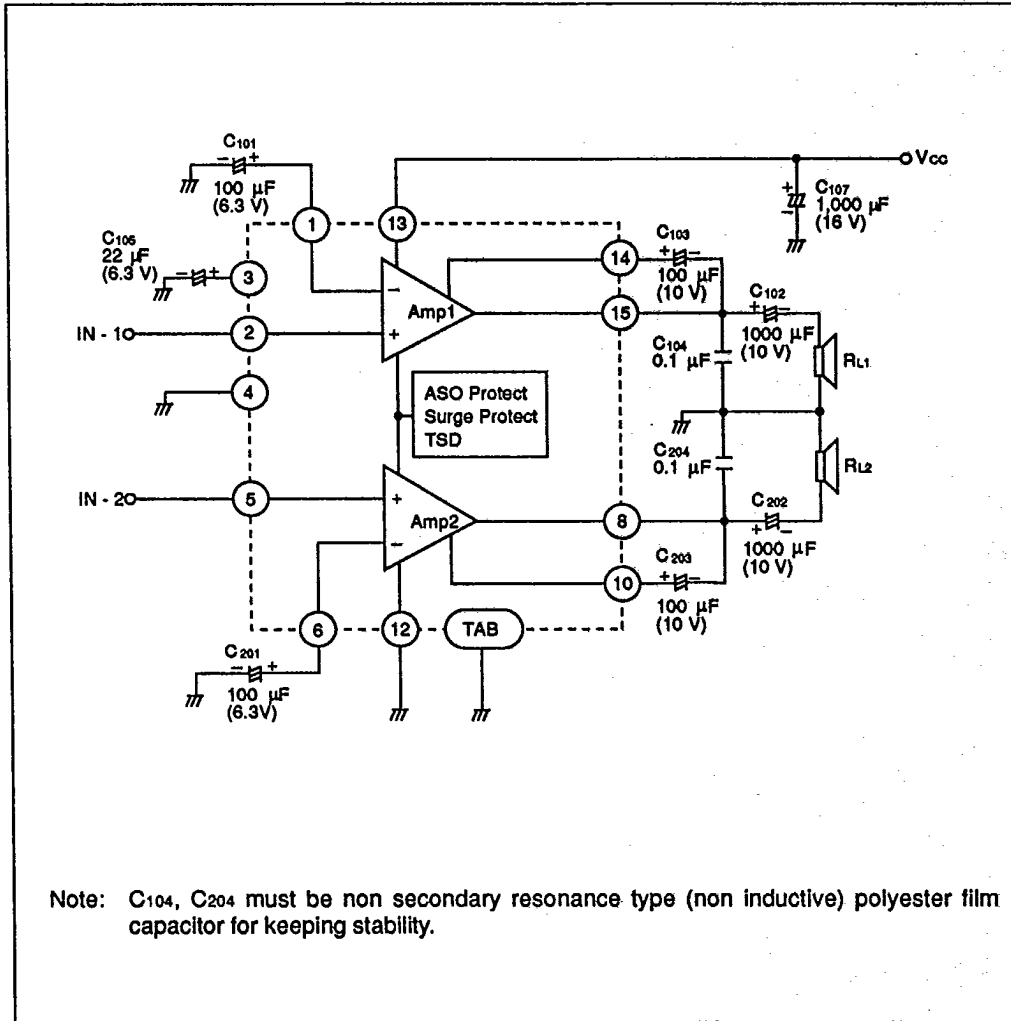

Note: C104, C204 must be non secondary resonance type (non inductive) polyester film capacitor for keeping stability.



HA13119

T-74-05-01

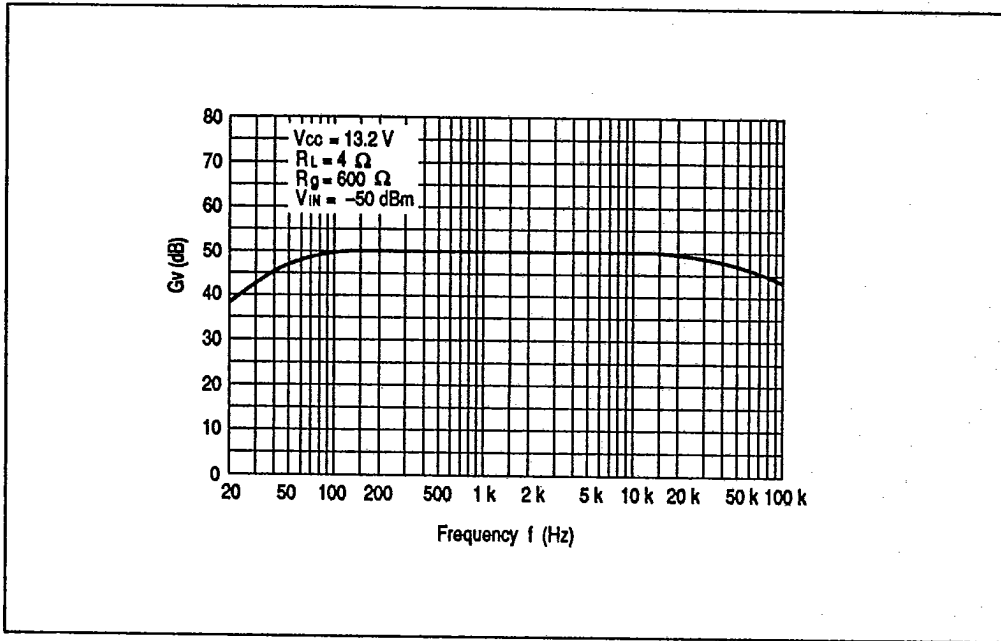

Voltage Gain vs. Frequency

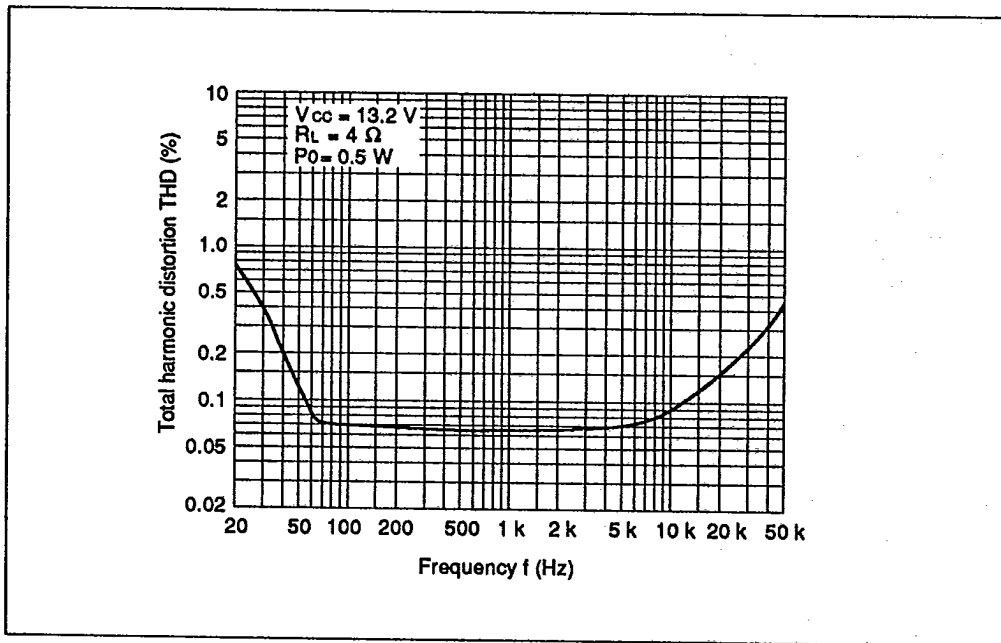

Total Harmonic Distortion vs. Frequency



356 Hitachi America, Ltd. • Hitachi Plaza • 2000 Sierra Point Pkwy. • Brisbane, CA 94005-1819 • (415) 589-8300

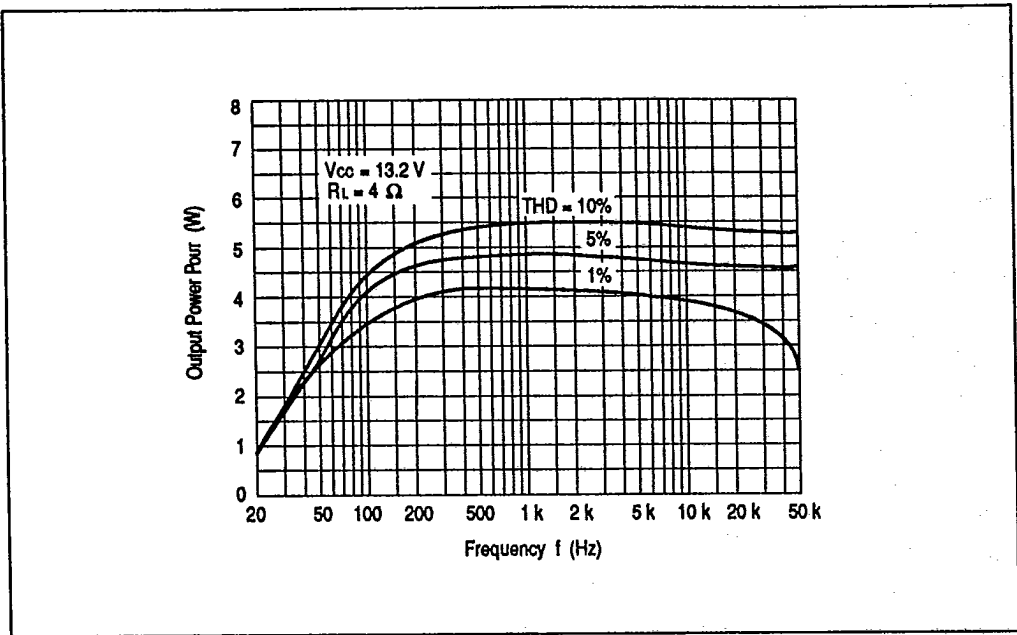

Output Power vs. Frequency

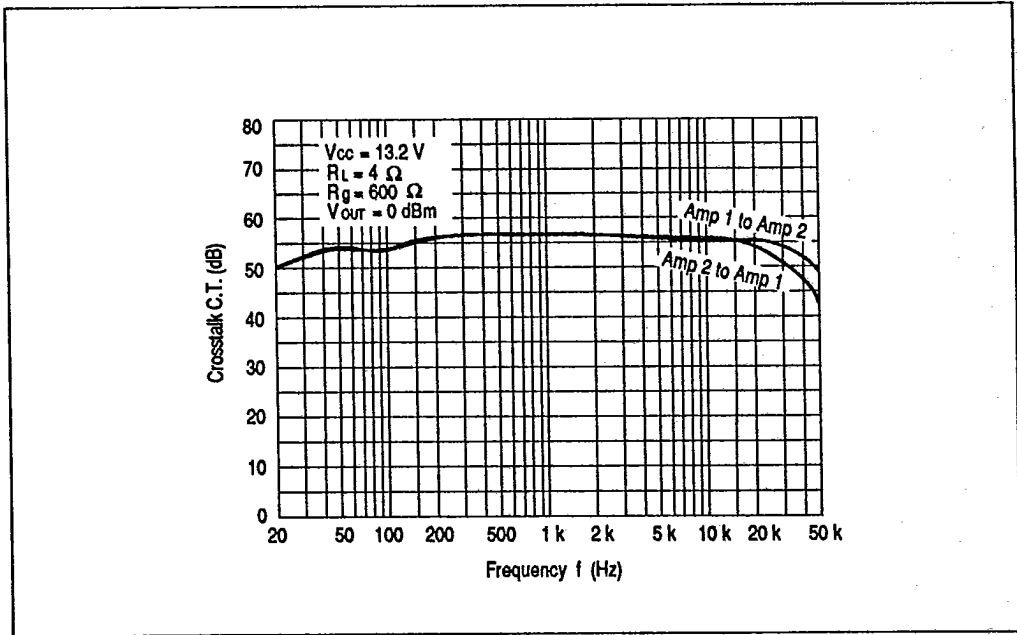

Cross-talk vs. Frequency



HA13119

T-74-05-01

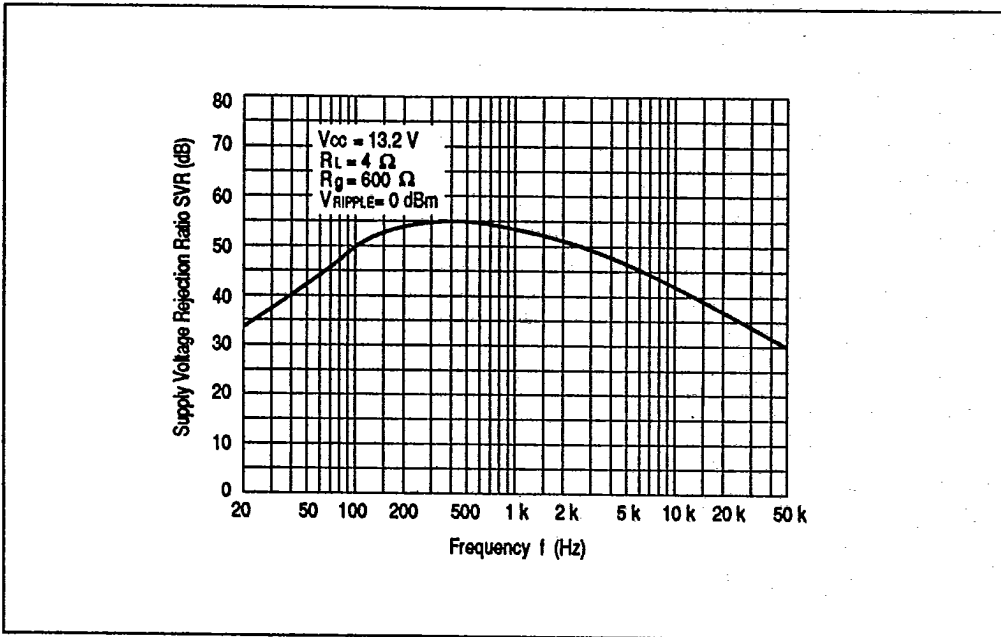

Supply Voltage Rejection Ratio vs. Frequency

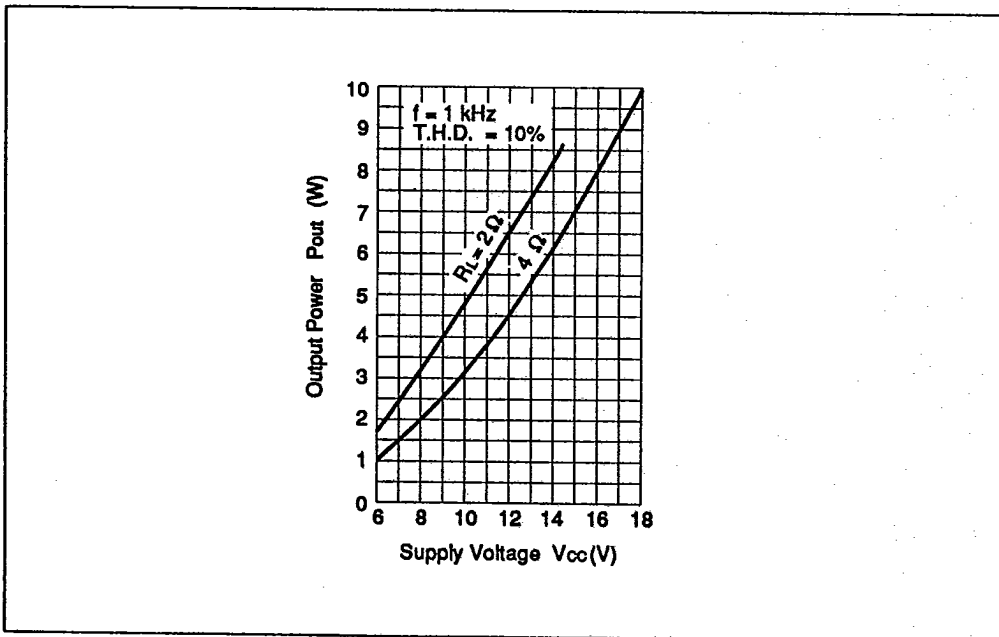

Output Power vs. Supply Voltage



358 Hitachi America, Ltd. • Hitachi Plaza • 2000 Sierra Point Pkwy. • Brisbane, CA 94005-1819 • (415) 589-8300

T-74-05-01

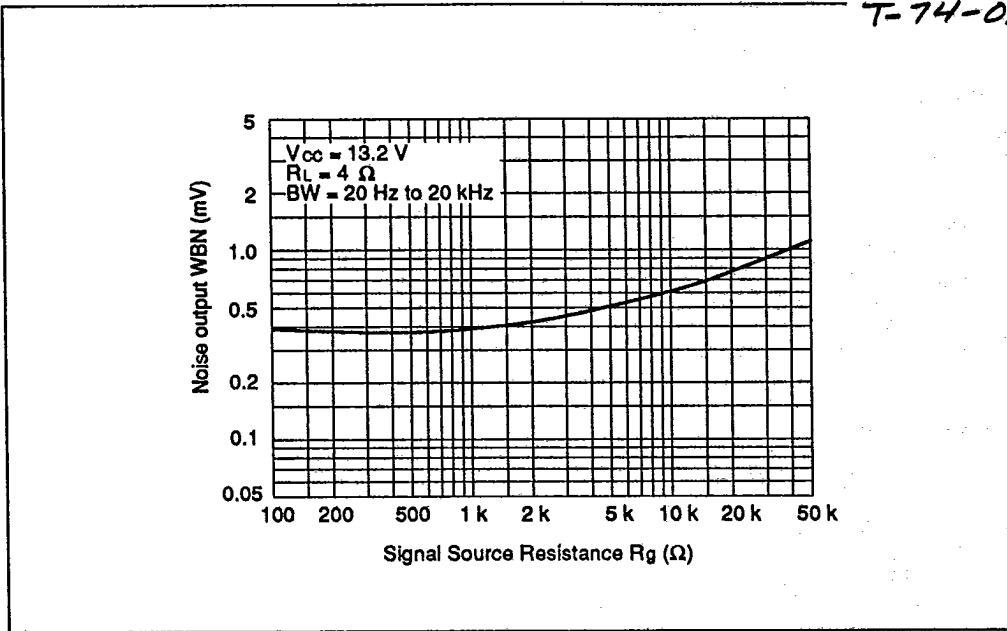

Noise Output vs. Signal Source Resistance

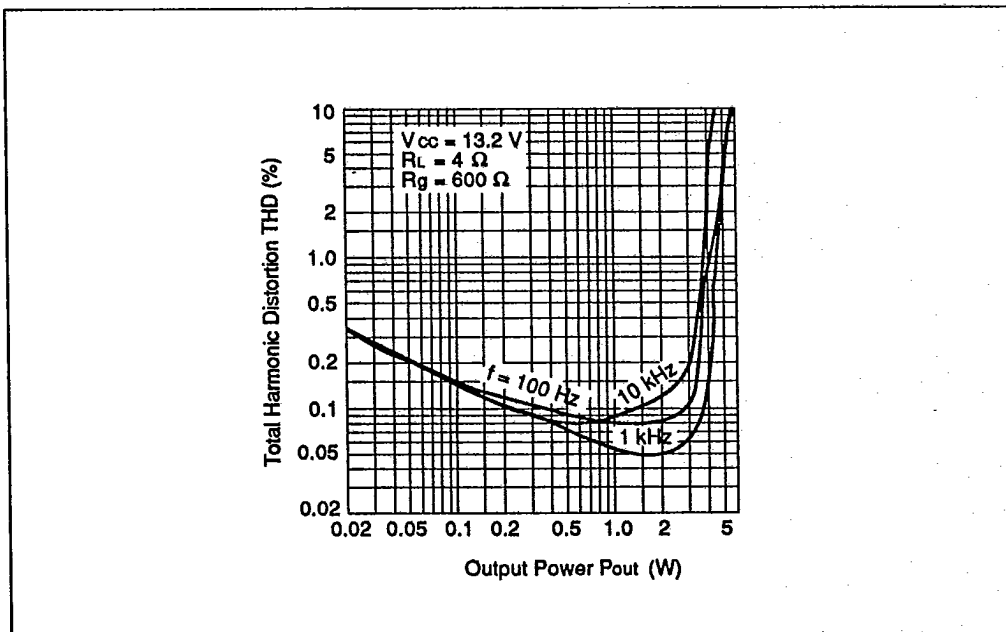

Total Harmonic Distortion vs. Output Power



HA13119

T-74-05-01

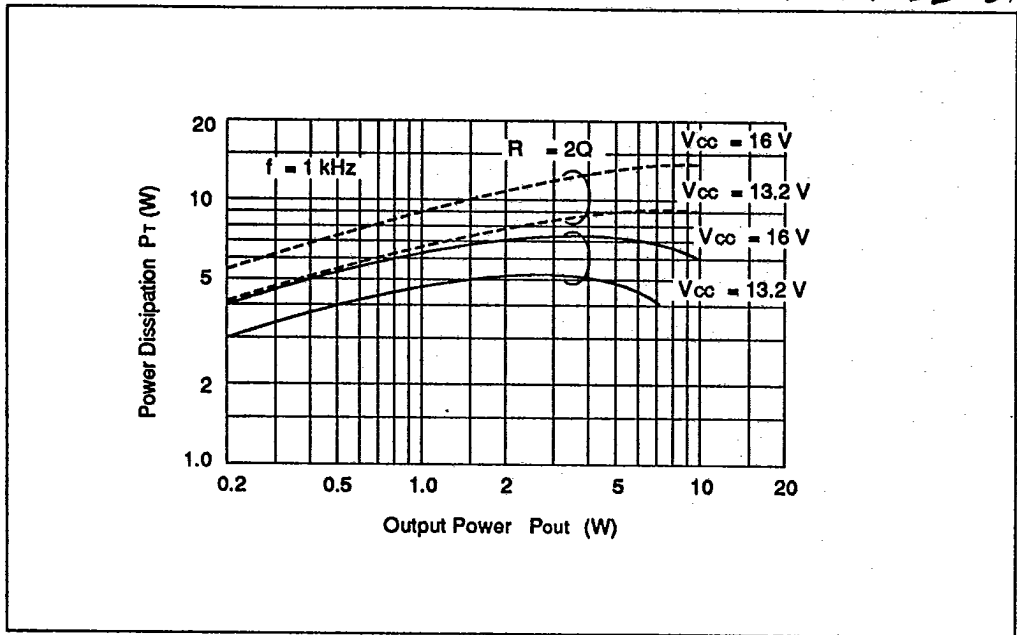

Power Dissipation vs. Output Power



360 Hitachi America, Ltd. • Hitachi Plaza • 2000 Sierra Point Pkwy. • Brisbane, CA 94005-1819 • (415) 589-8300



This datasheet has been download from:

[www.datasheetcatalog.com](http://www.datasheetcatalog.com)

Datasheets for electronics components.