

PQ05RF1 Series

1A Output Low Power-Loss Voltage Regulators

■ Features

- Compact resin full-mold package
- Low power-loss (Dropout voltage:MAX.0.5V)
- Built-in ON/OFF control terminal (PQ05RF1/PQ05RF11 series)
- Built-in output voltage minute adjustment terminal (Critical rate of ripple rejection is improved.) (PQ05RF1V series)
- Lead forming type (PQ05RF1A/1B series) is also available.

■ Model Line-ups

Output voltage	5Voutput	9Voutput	12Voutput
Output voltage precision:±5%	PQ05RF1	PQ09RF1	PQ12RF1
Output voltage precision:±2.5%	PQ05RF11	PQ09RF11	PQ12RF11
Minute adjustment (Output voltage adjustment range:±10%)	PQ05RF1V	PQ09RF1V	PQ12RF1V

■ Applications

- Seris power supply for various electronic equipment such as VCRs and musical instruments

■ Equivalent Circuit Diagram

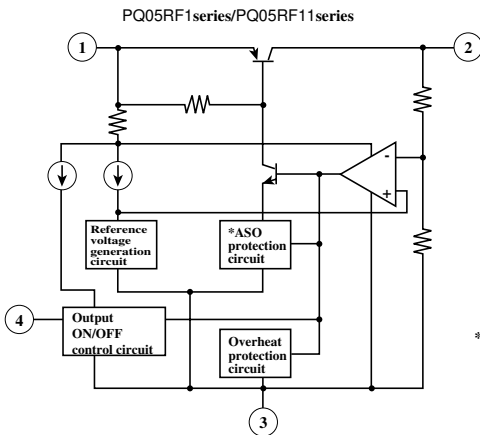

■ Outline Dimensions

(Unit : mm)

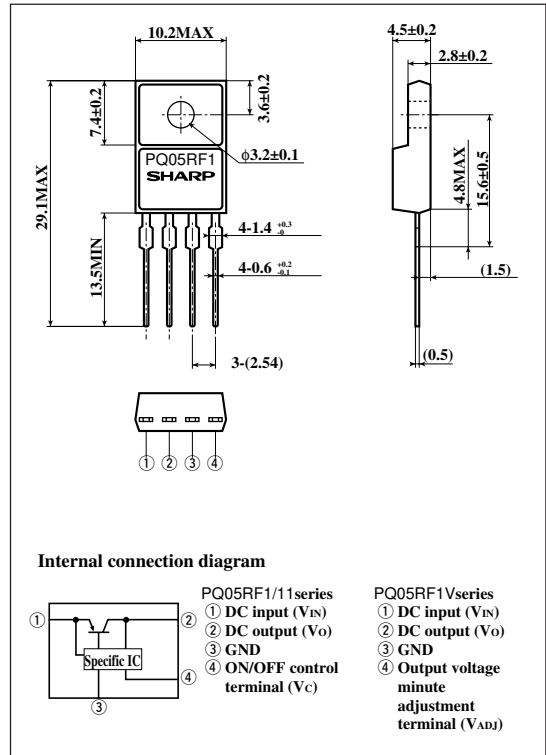

Internal connection diagram

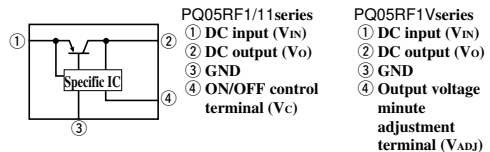

PQ05RF1/11series

- ① DC input (VIN)
- ② DC output (VO)
- ③ GND
- ④ ON/OFF control terminal (VC)

PQ05RF1Vseries

- ① DC input (VIN)
- ② DC output (VO)
- ③ GND
- ④ Output voltage minute adjustment terminal (VADJ)

PQ05RF1Vseries

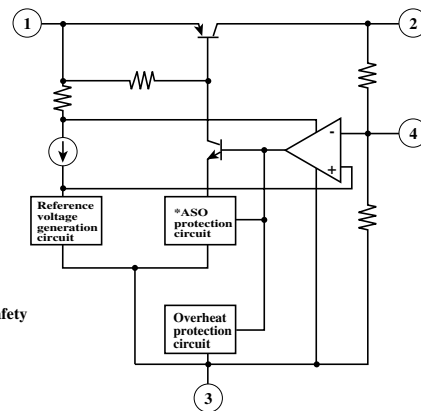

*ASO:Area of Safety Operation

· Please refer to the chapter " Handling Precautions " .

■ Absolute Maximum Ratings

(Ta=25°C)

Parameter		Symbol	Rating	Unit
*1	Input voltage	V _{IN}	35	V
*1	ON/OFF control terminal voltage	PQ05RF1 series	35	V
		PQ05RF11 series		
	Output current	I _o	1	A
	Power dissipation (No heat sink)	P _{D1}	1.5	W
	Power dissipation (With infinite heat sink)	P _{D2}	15	W
*2	Junction temperature	T _j	150	°C
	Operating temperature	T _{opr}	-20 to +80	°C
	Storage temperature	T _{stg}	-40 to +150	°C
	Soldering temperature	T _{sol}	260 (For 10s)	°C

*1 All are open except GND and applicable terminals.

*2 Overheat protection may operate at 125<T_j<150°C

■ Electrical Characteristics

(Unless otherwise specified, condition shall be I_o=0.5A, Ta=25°C,*3)

Parameter		Symbol	Conditions	MIN.	TYP.	MAX.	Unit	
Output voltage	PQ05RF1/PQ05RF1V	V _o	-	4.75	5.0	5.25	V	
	PQ09RF1/PQ09RF1V			8.55	9.0	9.45		
	PQ12RF1/PQ12RF1V			11.4	12.0	12.6		
	PQ05RF11			4.88	5.0	5.12		
	PQ09RF11			8.78	9.0	9.22		
	PQ12RF11			11.7	12.0	12.3		
Load regulation		R _{egL}	I _o =5mA to 1A	-	0.1	2.0	%	
Line regulation		R _{egI}	*4	-	0.5	2.5	%	
Temperature coefficient of output voltage			T _c V _o	T _j =0 to 125°C	-	±0.02	-	%/°C
Ripple rejection	PQ05RF1/PQ05RF11 series	RR	Refer to Fig. 2.	45	55	-	dB	
	PQ05RF1V series			55	-	-		
Dropout voltage		V _{i-o}	*5	-	-	0.5	V	
ON-state voltage for control	PQ05RF1/PQ05RF11 series	V _{C (ON)}	-	2.0	-	-	V	
ON-state current for control	PQ05RF1/PQ05RF11 series	I _{C (ON)}	V _C =2.7V	-	-	20	μA	
OFF-state voltage for control	PQ05RF1/PQ05RF11 series	V _{C (OFF)}	-	-	-	0.8	V	
OFF-state current for control	PQ05RF1/PQ05RF11 series	I _{C (OFF)}	V _C =0.4V	-	-	-0.4	mA	
Quiescent current		I _q	I _o =0	-	-	10	mA	
Output voltage minute adjustment characteristics	PQ05RF1V	V _{o (ADJ)}	-	4.5	5.0	5.5	V	
	PQ09RF1V			8.1	9.0	9.9		
	PQ12RF1V			10.8	12.0	13.2		

*3 PQ05RF1 series:V_{IN}=7V, PQ09RF1 series:V_{IN}=15V, PQ12RF1 series:V_{IN}=18V

*4 PQ05RF1/PQ05RF11/PQ05RF1V:V_{IN}=6 to 12V

PQ09RF1/PQ09RF11/PQ09RF1V:V_{IN}=10 to 25V

PQ12RF1/PQ12RF11/PQ12RF1V:V_{IN}=13 to 29V

*5 Input voltage shall be the value when output voltage is 95% in comparison with the initial value.

*6 In case of opening control terminal ④, output voltage turns on. (PQ05RF1/PQ05RF11 series)

Fig.1 Test Circuit

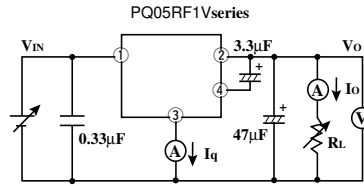
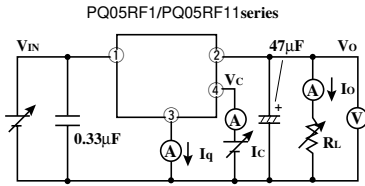

Fig.2 Test Circuit of Ripple Rejection

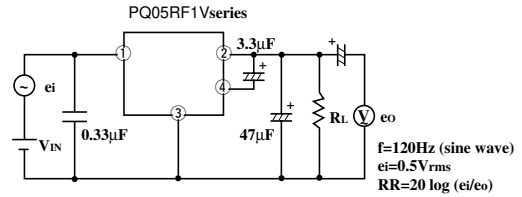
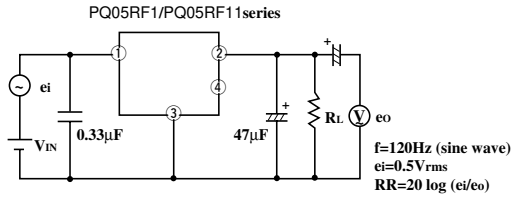
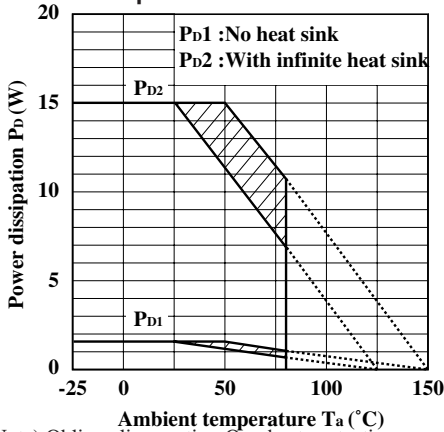

Fig.3 Power Dissipation vs. Ambient Temperature



Note) Oblique line portion: Overheat protection may operate in this area.

Fig.4 Overcurrent Protection Characteristics (Typical Value)

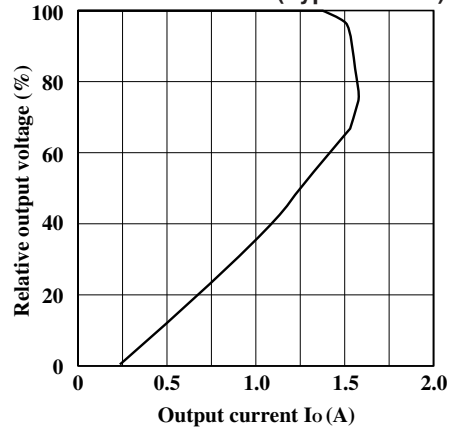

Fig.5 Output Voltage Minute Adjustment Characteristics (PQ05RF1V)

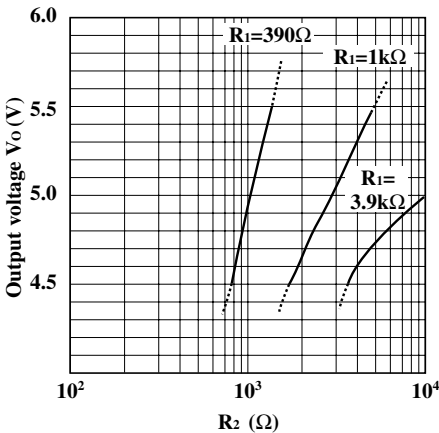

Fig.6 Output Voltage Minute Adjustment Characteristics (PQ09RF1V)

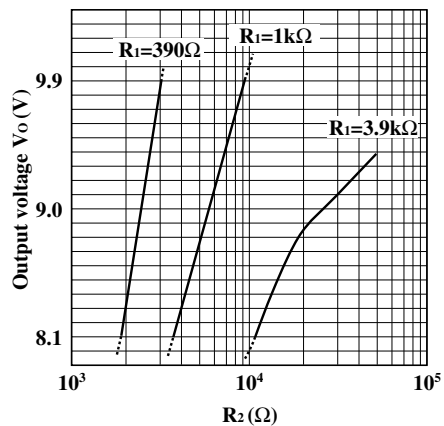

Fig.7 Output Voltage Minute Adjustment Characteristics (PQ12RF1V)

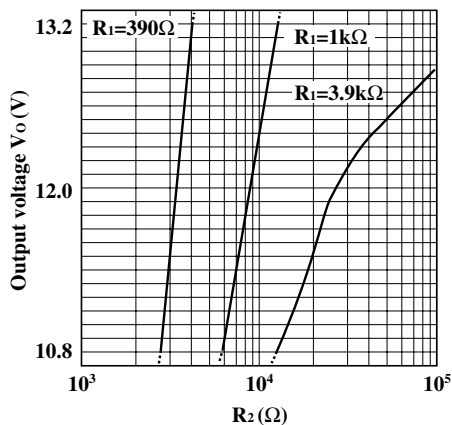

Fig.8 Output Voltage Deviation vs. Junction Temperature (PQ05RF1/PQ05RF11/PQ05RF1V)

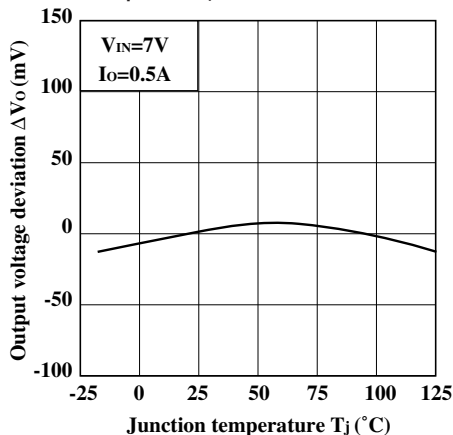

Fig.9 Output Voltage Deviation vs. Junction Temperature (PQ09RF1/PQ09RF11/PQ09RF1V)

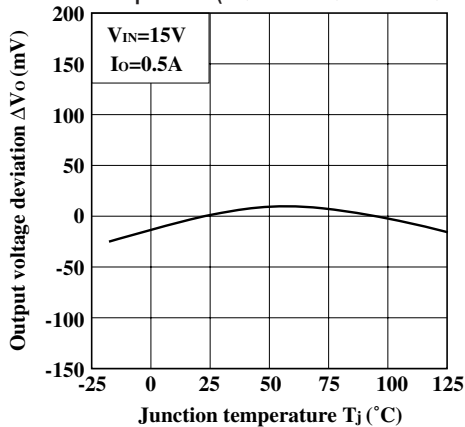

Fig.10 Output Voltage Deviation vs. Junction Temperature (PQ12RF1/PQ12RF11/PQ12RF1V)

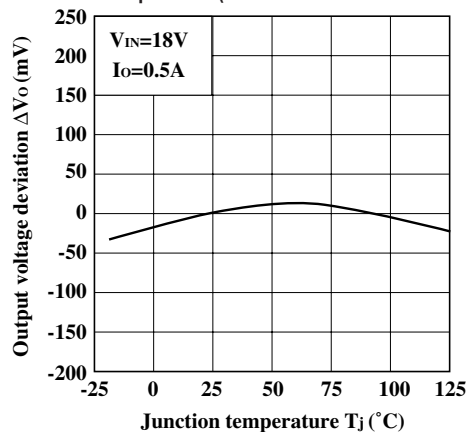

Fig.11 Output Voltage vs. Input Voltage (PQ05RF1/PQ05RF11/PQ05RF1V)

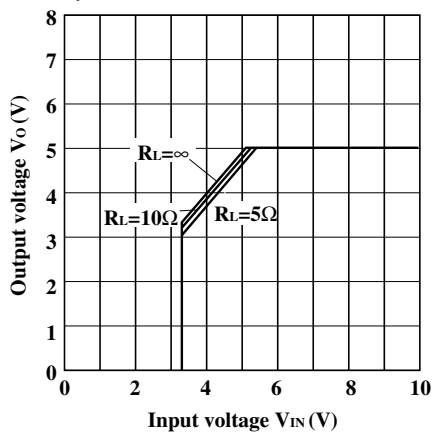

Fig.12 Output Voltage vs. Input Voltage (PQ09RF1/PQ09RF11/PQ09RF1V)

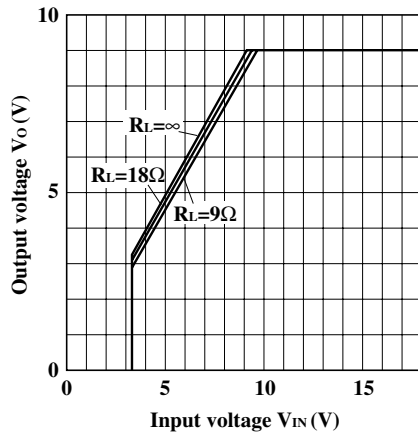

Fig.13 Output Voltage vs. Input Voltage (PQ12RF1/PQ12RF11/PQ12RF1V)

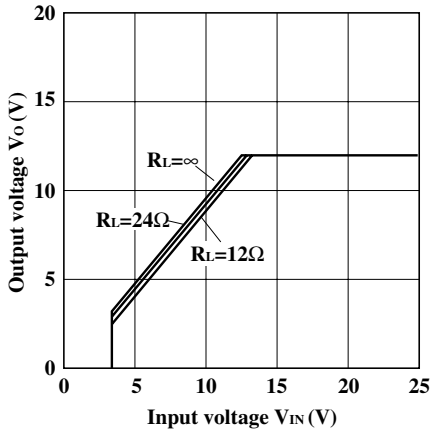

Fig.14 Circuit Operating Current vs. Input Voltage (PQ05RF1/PQ05RF11/PQ05RF1V)

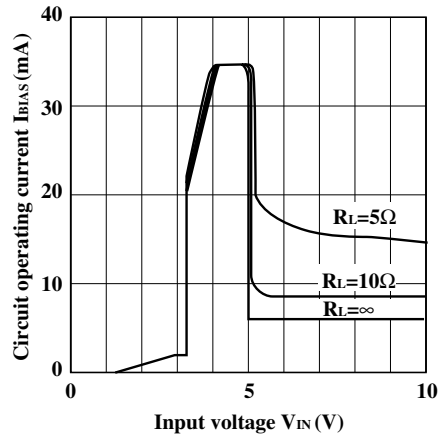

Fig.15 Circuit Operating Current vs. Input Voltage (PQ09RF1/PQ09RF11/PQ09RF1V)

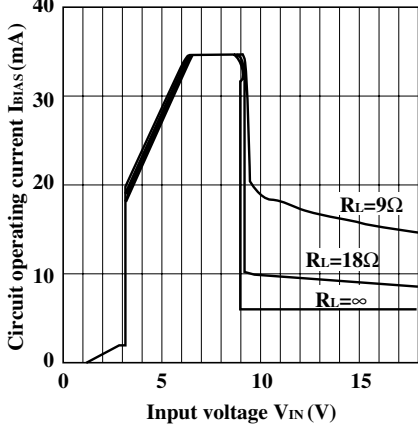

Fig.16 Circuit Operating Current vs. Input Voltage (PQ12RF1/PQ12RF11/PQ12RF1V)

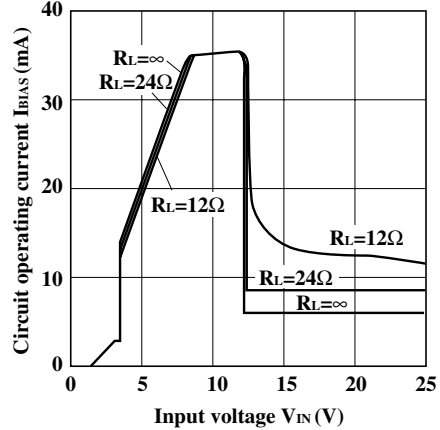

Fig.17 Dropout Voltage vs. Junction Temperature

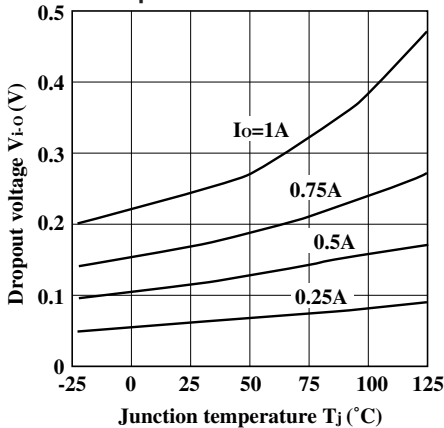

Fig.18 Quiescent Current vs. Junction Temperature

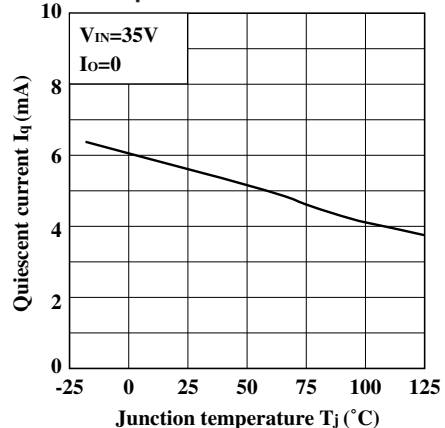

Fig.19 Ripple Rejection vs. Input Ripple Frequency (PQ05RF1/PQ05RF11/PQ09RF1/PQ09RF11/PQ12RF1/PQ12RF11)

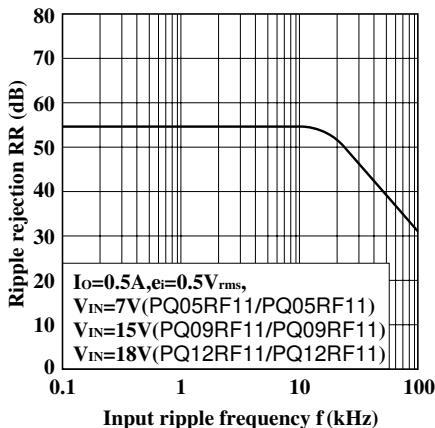

Fig.20 Ripple Rejection vs. Input Ripple Frequency (PQ05RF1V/PQ09RF1V/PQ12RF1V)

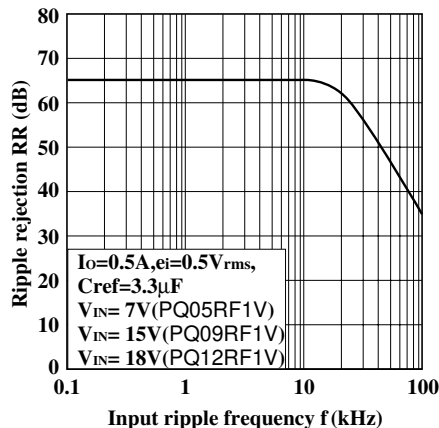
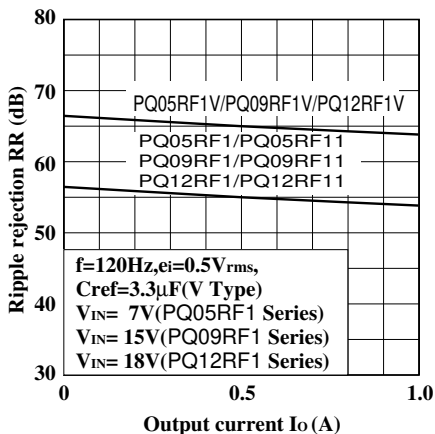
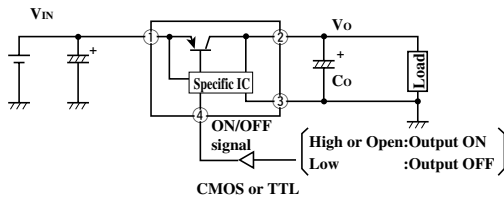

Fig.21 Ripple Rejection vs. Output Current



■ Typical Application

PQ05RF1/PQ05RF11 Series



PQ05RF1V Series

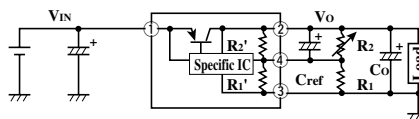

$$V_o = V_{ref} \times \left(1 + \frac{R_2' \times R_2}{R_2' + R_2} \cdot \frac{R_1' + R_1}{R_1' \times R_1} \right)$$

$V_{ref} \approx 1.26V, R_1' \approx 390\Omega$
 PQ05RF1V : $R_2' \approx 1.16k\Omega$
 PQ09RF1V : $R_2' \approx 2.40k\Omega$
 PQ12RF1V : $R_2' \approx 3.32k\Omega$

(Note) R_1' and R_2' are built in a specific IC.

Model Line-ups for Lead Forming Type

Output voltage	5V output	9V output	12V output
Output voltage precision:±5%	PQ05RF1A	PQ09RF1A	PQ12RF1A
Output voltage precision:±2.5%	PQ05RF1B	PQ09RF1B	PQ12RF1B

Outline Dimensions (PQ05RF1A/PQ05RF1B series)

(Unit : mm)

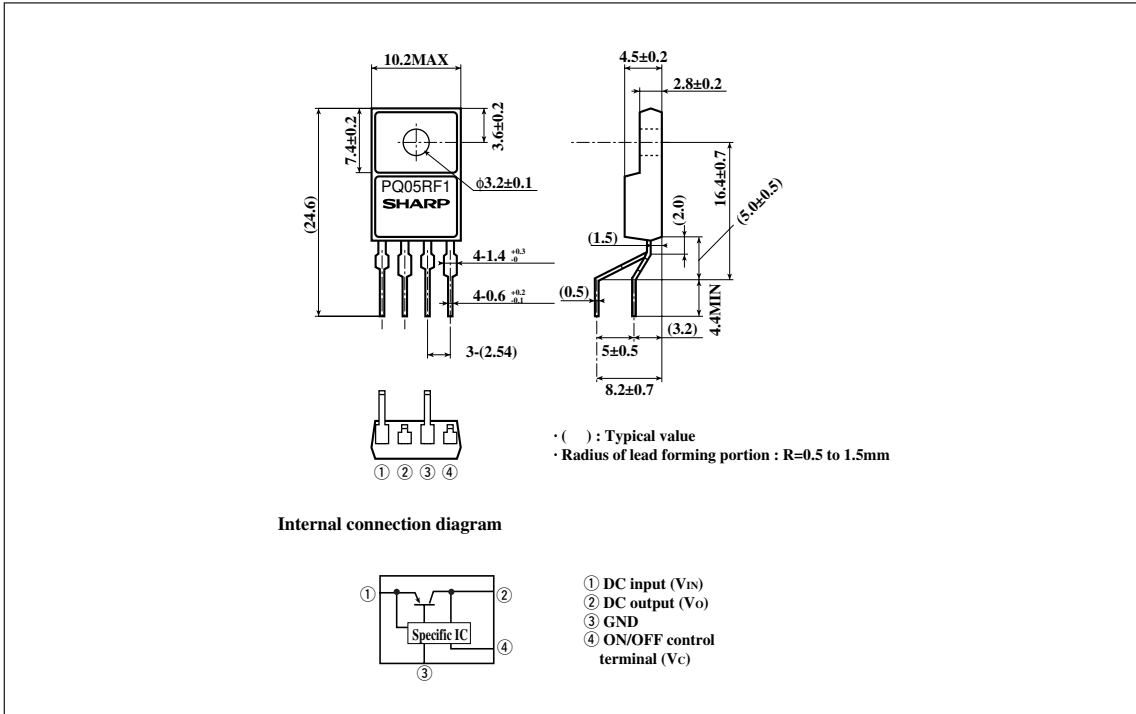

Note) The value absolute maximum ratings and electrical characteristics is same as ones of PQ05RF1/11 series.

Precautions for Use

(1) Minute adjustment of output voltage (PQ05RF1V series)

If the external resistor is attached to the terminals ②, ③ and ④, minute adjustment of output voltage is possible.

(Refer to the example of basic circuit (PQ05RF1V series) and Fig.5 to 7.)