



## BUH315D

# HIGH VOLTAGE FAST-SWITCHING NPN POWER TRANSISTOR

- STMicroelectronics PREFERRED SALESTYPE
- HIGH VOLTAGE CAPABILITY
- U.L. RECOGNISED ISOWATT218 PACKAGE (U.L. FILE # E81734 (N))
- NPN TRANSISTOR WITH INTEGRATED FREEWHEELING DIODE.

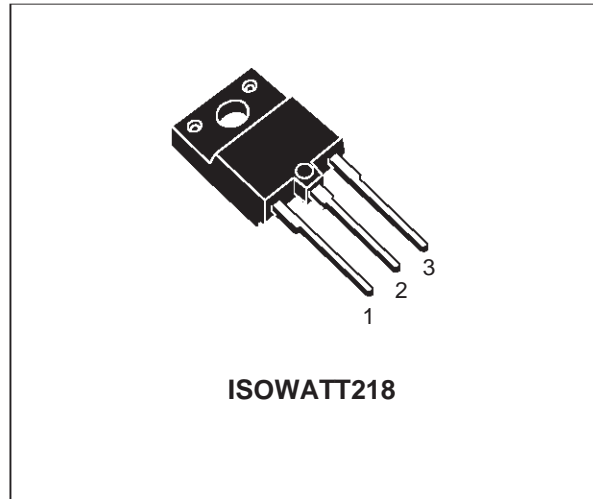
### APPLICATIONS

- HORIZONTAL DEFLECTION FOR COLOUR TV

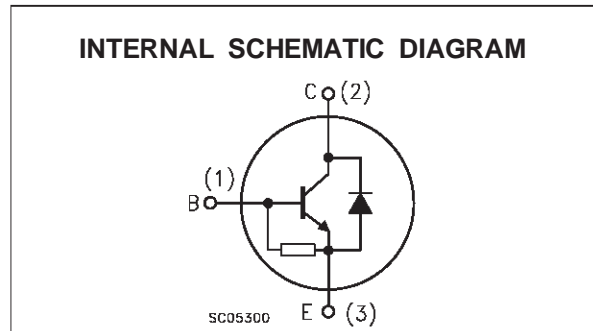
### DESCRIPTION

The BUH315D is manufactured using Multi-epitaxial Mesa technology for cost-effective high performance and uses a Hollow Emitter structure to enhance switching speeds.

The BUH series is designed for use in horizontal deflection circuits in televisions and monitors.



ISOWATT218



### ABSOLUTE MAXIMUM RATINGS

Symbol	Parameter	Value	Unit
$V_{CBO}$	Collector-Base Voltage ( $I_E = 0$ )	1500	V
$V_{CEO}$	Collector-Emitter Voltage ( $I_B = 0$ )	700	V
$V_{EBO}$	Emitter-Base Voltage ( $I_C = 0$ )	10	V
$I_C$	Collector Current	6	A
$I_{CM}$	Collector Peak Current ( $t_p < 5$ ms)	12	A
$I_B$	Base Current	3	A
$I_{BM}$	Base Peak Current ( $t_p < 5$ ms)	5	A
$P_{tot}$	Total Dissipation at $T_c = 25$ °C	44	W
$T_{stg}$	Storage Temperature	-65 to 150	°C
$T_j$	Max. Operating Junction Temperature	150	°C

# BUH315D

## THERMAL DATA

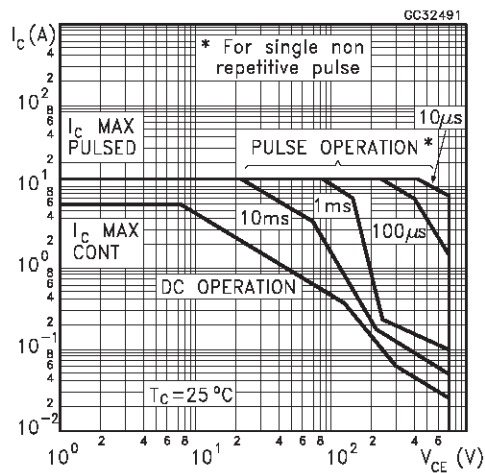
R <sub>thj-case</sub>	Thermal Resistance Junction-case	Max	2.8	°C/W
-----------------------	----------------------------------	-----	-----	------

## ELECTRICAL CHARACTERISTICS (T<sub>case</sub> = 25 °C unless otherwise specified)

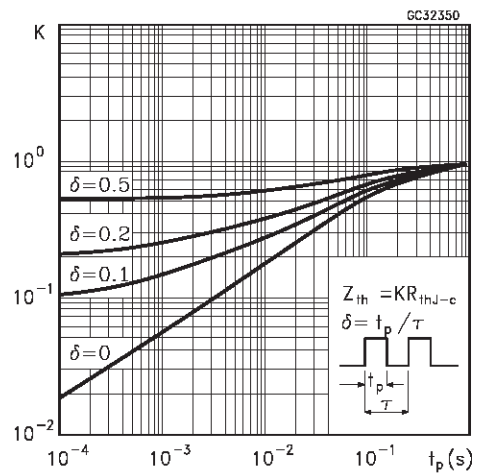
Symbol	Parameter	Test Conditions	Min.	Typ.	Max.	Unit
I <sub>CES</sub>	Collector Cut-off Current (V <sub>BE</sub> = 0)	V <sub>CE</sub> = 1500 V			200	μA
I <sub>EBO</sub>	Emitter Cut-off Current (I <sub>C</sub> = 0)	V <sub>EB</sub> = 5 V			300	mA
V <sub>CE(sat)*</sub>	Collector-Emitter Saturation Voltage	I <sub>C</sub> = 3 A    I <sub>B</sub> = 1 A			1.5	V
V <sub>BE(sat)*</sub>	Base-Emitter Saturation Voltage	I <sub>C</sub> = 3 A    I <sub>B</sub> = 1 A			1.5	V
h <sub>FE*</sub>	DC Current Gain	I <sub>C</sub> = 3 A    V <sub>CE</sub> = 5 V I <sub>C</sub> = 3 A    V <sub>CE</sub> = 5 V    T <sub>J</sub> = 100 °C	4 2.5		9	
t <sub>s</sub> t <sub>f</sub>	RESISTIVE LOAD Storage Time Fall Time	V <sub>CC</sub> = 400 V    I <sub>C</sub> = 3 A I <sub>B1</sub> = 1 A    I <sub>B2</sub> = -1.5 A		1.8 200	2.7 300	μs ns
t <sub>s</sub> t <sub>f</sub>	INDUCTIVE LOAD Storage Time Fall Time	I <sub>C</sub> = 3 A    f = 15625 Hz I <sub>B1</sub> = 1 A    I <sub>B2</sub> = 1.5 A V <sub>ceflyback</sub> = 1050 sin(π/5 · 10 <sup>6</sup> ) t V		2.7 350		μs ns
V <sub>F</sub>	Diode Forward Voltage	I <sub>F</sub> = 3 A			2.5	V

\* Pulsed: Pulse duration = 300 μs, duty cycle 1.5 %

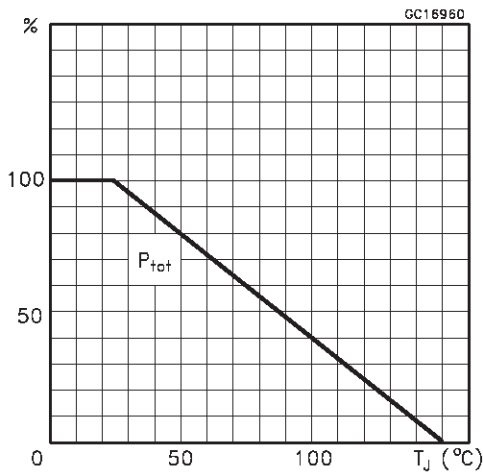
## Safe Operating Area



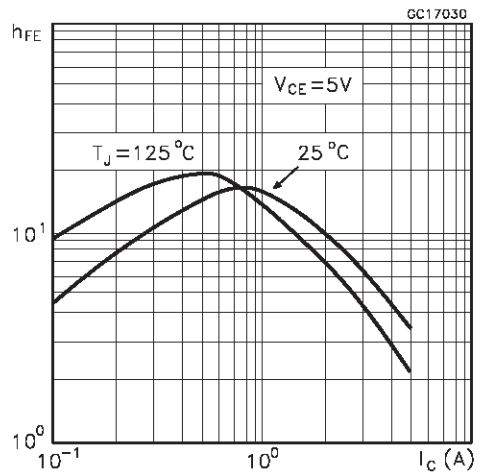
## Thermal Impedance



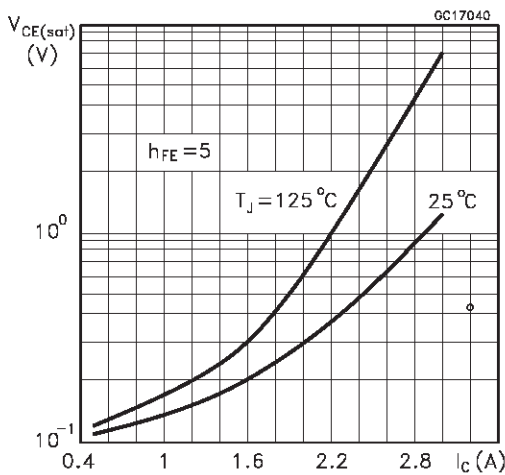
Derating Curve



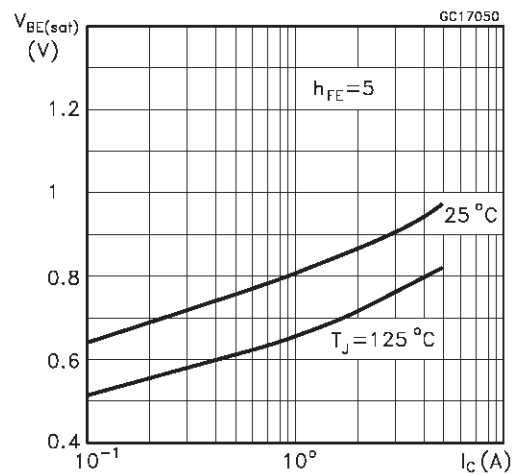
DC Current Gain



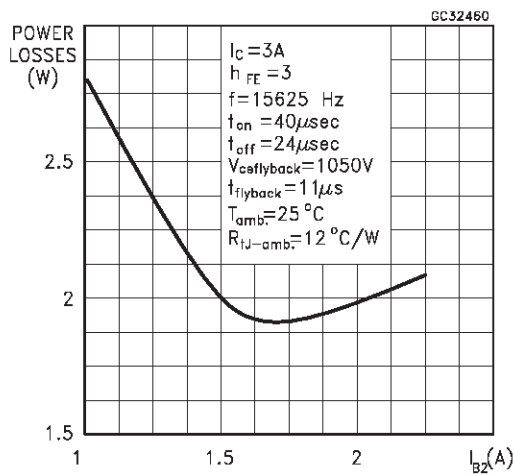
Collector Emitter Saturation Voltage



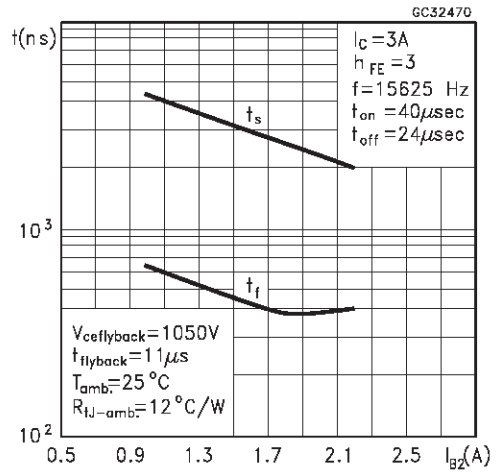
Base Emitter Saturation Voltage



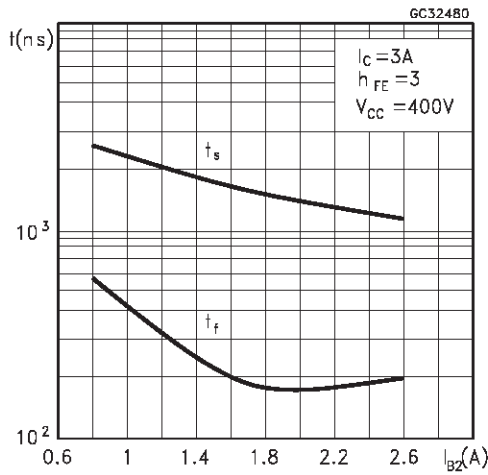
Power Losses at 16 KHz



Switching Time Inductive Load at 16KHz (see figure 2)



Switching Time Resistive Load at 16 KHz



**BASE DRIVE INFORMATION**

In order to saturate the power switch and reduce conduction losses, adequate direct base current  $I_{B1}$  has to be provided for the lowest gain  $h_{FE}$  at 100 °C (line scan phase). On the other hand, negative base current  $I_{B2}$  must be provided to turn off the power transistor (retrace phase).

Most of the dissipation, in the deflection application, occurs at switch-off. Therefore it is essential to determine the value of  $I_{B2}$  which minimizes power losses, fall time  $t_f$  and, consequently,  $T_j$ . A new set of curves have been defined to give total power losses,  $t_s$  and  $t_f$  as a function of  $I_{B2}$  at 16 KHz scanning frequencies the optimum negative drive. The test circuit is illustrated in fig. 1.

Inductance  $L_1$  serves to control the slope of the negative base current  $I_{B2}$  to recombine the excess carrier in the collector when base current is still present, this would avoid any tailing phenomenon in the collector current.

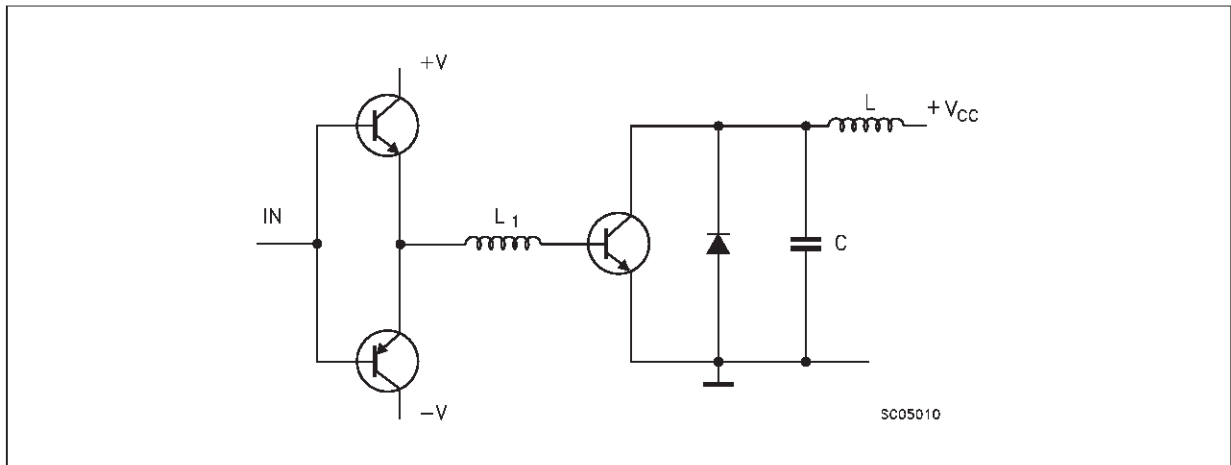
The values of L and C are calculated from the following equations:

$$\frac{1}{2} L (I_C)^2 = \frac{1}{2} C (V_{CEfly})^2$$

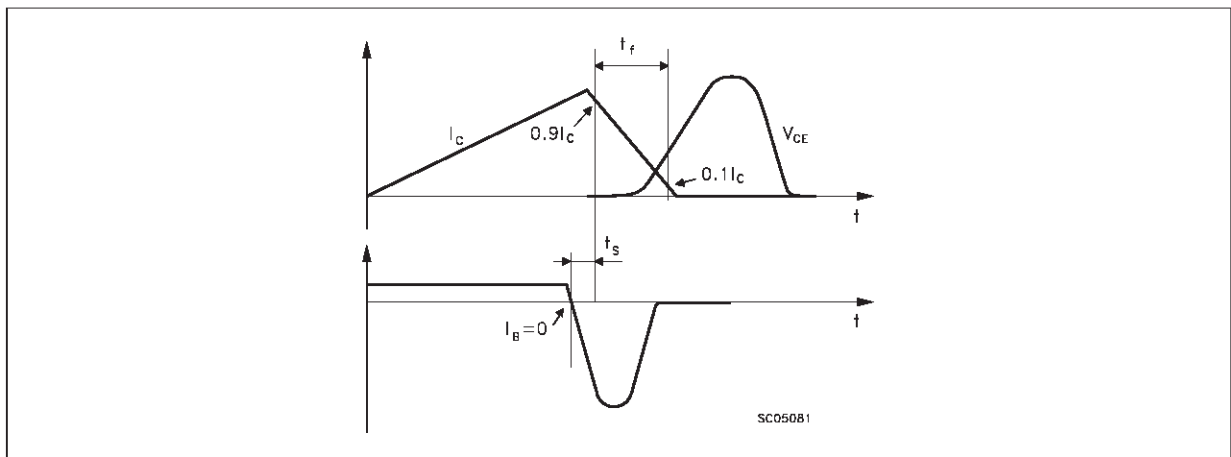
$$\omega = 2 \pi f = \frac{1}{\sqrt{LC}}$$

Where  $I_C$ = operating collector current,  $V_{CEfly}$ = flyback voltage,  $f$ = frequency of oscillation during retrace.

**Figure 1:** Inductive Load Switching Test Circuits.

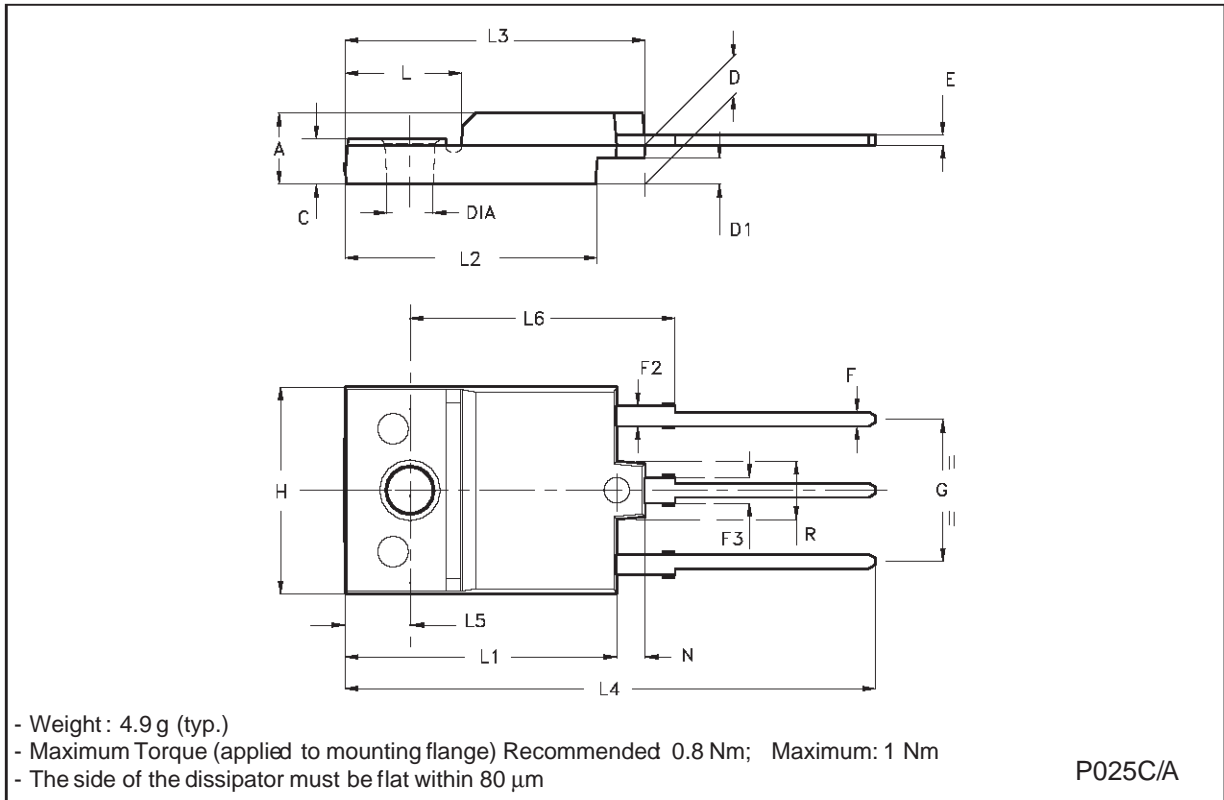


**Figure 2:** Switching Waveforms in a Deflection Circuit



**ISOWATT218 MECHANICAL DATA**

DIM.	mm			inch		
	MIN.	TYP.	MAX.	MIN.	TYP.	MAX.
A	5.35		5.65	0.211		0.222
C	3.30		3.80	0.130		0.150
D	2.90		3.10	0.114		0.122
D1	1.88		2.08	0.074		0.082
E	0.75		0.95	0.030		0.037
F	1.05		1.25	0.041		0.049
F2	1.50		1.70	0.059		0.067
F3	1.90		2.10	0.075		0.083
G	10.80		11.20	0.425		0.441
H	15.80		16.20	0.622		0.638
L		9			0.354	
L1	20.80		21.20	0.819		0.835
L2	19.10		19.90	0.752		0.783
L3	22.80		23.60	0.898		0.929
L4	40.50		42.50	1.594		1.673
L5	4.85		5.25	0.191		0.207
L6	20.25		20.75	0.797		0.817
N	2.1		2.3	0.083		0.091
R		4.6			0.181	
DIA	3.5		3.7	0.138		0.146



- Weight : 4.9 g (typ.)
- Maximum Torque (applied to mounting flange) Recommended 0.8 Nm; Maximum: 1 Nm
- The side of the dissipator must be flat within 80 μm

P025C/A

Information furnished is believed to be accurate and reliable. However, STMicroelectronics assumes no responsibility for the consequences of use of such information nor for any infringement of patents or other rights of third parties which may result from its use. No license is granted by implication or otherwise under any patent or patent rights of STMicroelectronics. Specification mentioned in this publication are subject to change without notice. This publication supersedes and replaces all information previously supplied. STMicroelectronics products are not authorized for use as critical components in life support devices or systems without express written approval of STMicroelectronics.

The ST logo is a trademark of STMicroelectronics

© 1999 STMicroelectronics – Printed in Italy – All Rights Reserved

STMicroelectronics GROUP OF COMPANIES

Australia - Brazil - China - Finland - France - Germany - Hong Kong - India - Italy - Japan - Malaysia - Malta - Morocco -  
Singapore - Spain - Sweden - Switzerland - United Kingdom - U.S.A.

<http://www.st.com>



This datasheet has been download from:

[www.datasheetcatalog.com](http://www.datasheetcatalog.com)

Datasheets for electronics components.