

International
IRF Rectifier

61CTQ045

SCHOTTKY RECTIFIER

60 Amp

Major Ratings and Characteristics

Characteristics	Values	Units
$I_{F(AV)}$ Rectangular waveform (Per Device)	60	A
I_{FRM} @ $T_C = 142^\circ\text{C}$ (Per Leg)	60	A
V_{RRM}	45	V
I_{FSM} @ $t_p = 5 \mu\text{s}$ sine	2600	A
V_F @ $30 \text{ A pk}, T_J = 125^\circ\text{C}$	0.57	V
T_J range	-65 to 175	$^\circ\text{C}$

Description/Features

This center tap Schottky rectifier has been optimized for low reverse leakage at high temperature. The proprietary barrier technology allows for reliable operation up to 175°C junction temperature. Typical applications are in switching power supplies, converters, free-wheeling diodes, and reverse battery protection.

- 175°C T_J operation
- Center tap TO-220 package
- Low forward voltage drop
- High purity, high temperature epoxy encapsulation for enhanced mechanical strength and moisture resistance
- High frequency operation
- Guard ring for enhanced ruggedness and long term reliability

Case Styles

61CTQ045



TO-220

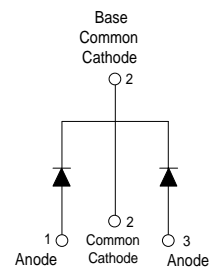

Voltage Ratings

Parameters	61CTQ045
V_R Max. DC Reverse Voltage (V)	45
V_{RWM} Max. Working Peak Reverse Voltage (V)	

Absolute Maximum Ratings

Parameters	Values	Units	Conditions
$I_{F(AV)}$ Max. Average Forward Current (Per Leg) (Per Device)	30	A	@ $T_C = 142^\circ\text{C}$, (Rated V_R)
	60		
I_{FRM} Peak Repetitive Forward Current (Per Leg)	60	A	Rated V_R , square wave, 20kHz $T_C = 142^\circ\text{C}$
I_{FSM} Max. Peak One Cycle Non-Repetitive Surge Current (Per Leg)	2600	A	5 μs Sine or 3 μs Rect. pulse 10ms Sine or 6ms Rect. pulse Following any rated load condition and with rated V_{RRM} applied
	350		
E_{AS} Non-Repetitive Avalanche Energy (Per Leg)	27	mJ	$T_J = 25^\circ\text{C}$, $I_{AS} = 4\text{Amps}$, $L = 3.4\text{mH}$
I_{AR} Repetitive Avalanche Current (Per Leg)	4	A	Current decaying linearly to zero in 1 μsec Frequency limited by T_J max. $V_A = 1.5 \times V_R$ typical

Electrical Specifications

Parameters	Typ.	Max.	Units	Conditions
V_{FM} Max. Forward Voltage Drop (1)	0.57	0.61	V	@ 30A $T_J = 25^\circ\text{C}$
	0.72	0.76	V	@ 60A
	0.53	0.57	V	@ 30A $T_J = 125^\circ\text{C}$
	0.70	0.74	V	@ 60A
I_{RM} Max. Instantaneous Reverse Current	0.06	1	mA	$T_J = 25^\circ\text{C}$ Rated DC voltage
	21	40	mA	$T_J = 125^\circ\text{C}$
C_T Max. Junction Capacitance	1900		pF	$V_R = 5V_{DC}$ (test signal range 100Khz to 1Mhz) 25°C
L_S Typical Series Inductance	8.0		nH	Measured from top of terminal to mounting plane
dv/dt Max. Voltage Rate of Change (Rated V_R)	10000		V/ μs	

(1) Pulse Width < 300 μs , Duty Cycle < 2%

Thermal-Mechanical Specifications

Parameters	Values	Units	Conditions
T_J Max. Junction Temperature Range	-65 to 175	$^\circ\text{C}$	
T_{stg} Max. Storage Temperature Range	-65 to 175	$^\circ\text{C}$	
R_{thJC} Max. Thermal Resistance Junction to Case (Per Leg)	1.2	$^\circ\text{C/W}$	DC operation
R_{thCS} Typical Thermal Resistance Case to Heatsink	0.50	$^\circ\text{C/W}$	Mounting surface, smooth and greased
wt Approximate Weight	2 (0.07)	g (oz.)	
T Mounting Torque	Min.	6 (5)	Kg-cm (lbf-in)
	Max.	12 (10)	

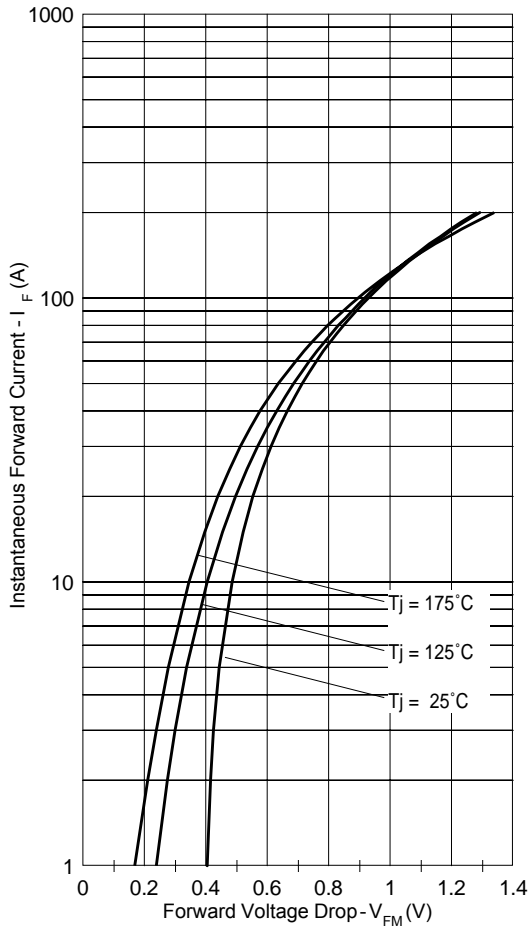

Fig. 1 - Maximum Forward Voltage Drop Characteristics

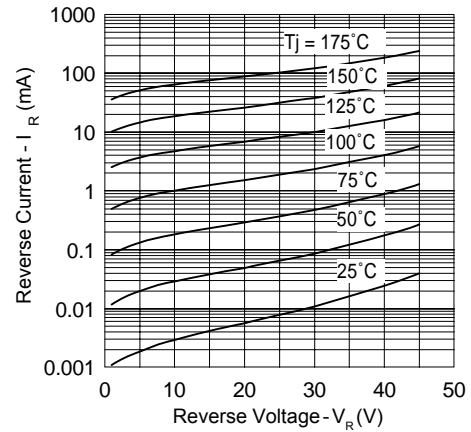

Fig. 2 - Typical Values of Reverse Current Vs. Reverse Voltage

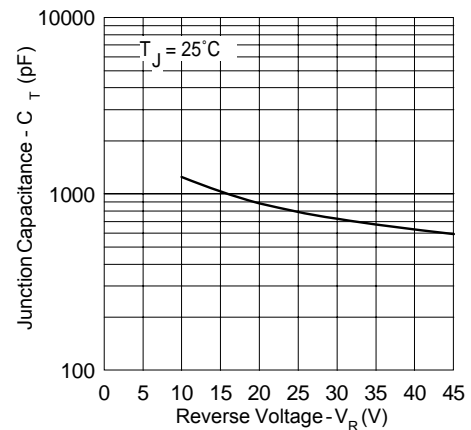

Fig. 3 - Typical Junction Capacitance Vs. Reverse Voltage

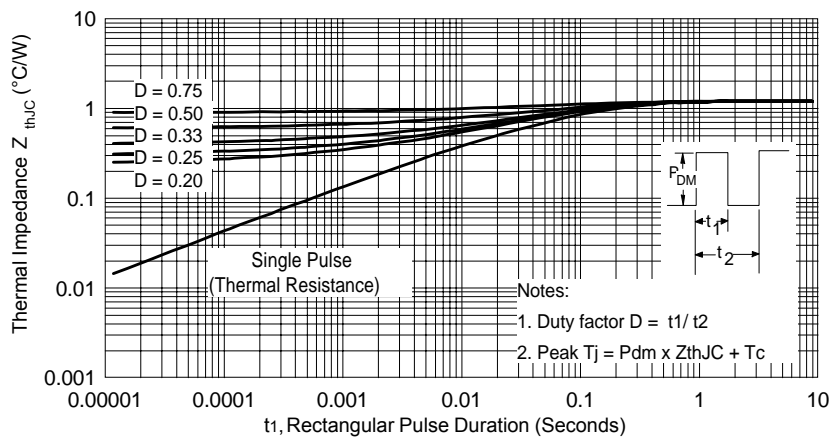

Fig. 4 - Max. Thermal Impedance Z_{thJC} Characteristics

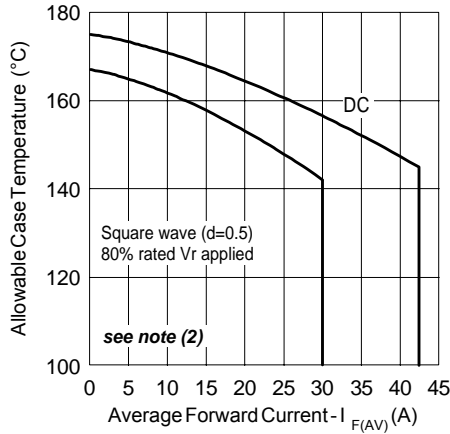

Fig. 5 - Max. Allowable Case Temperature Vs. Average Forward Current

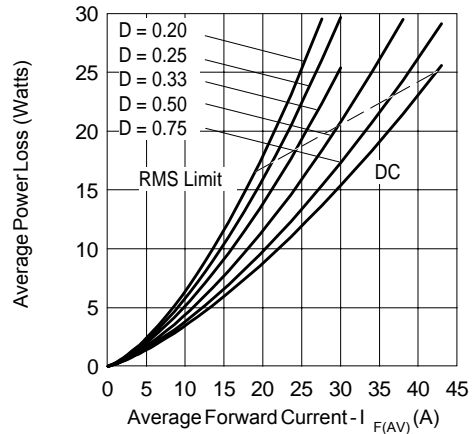

Fig. 6 - Forward Power Loss Characteristics

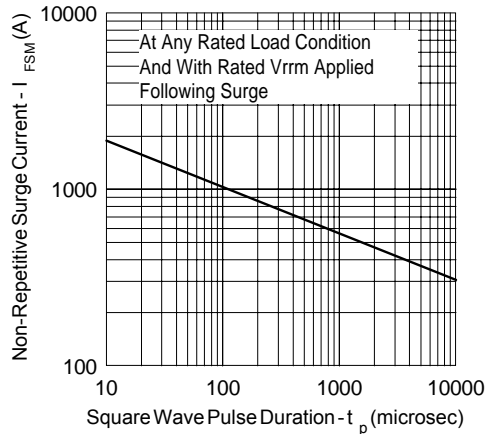
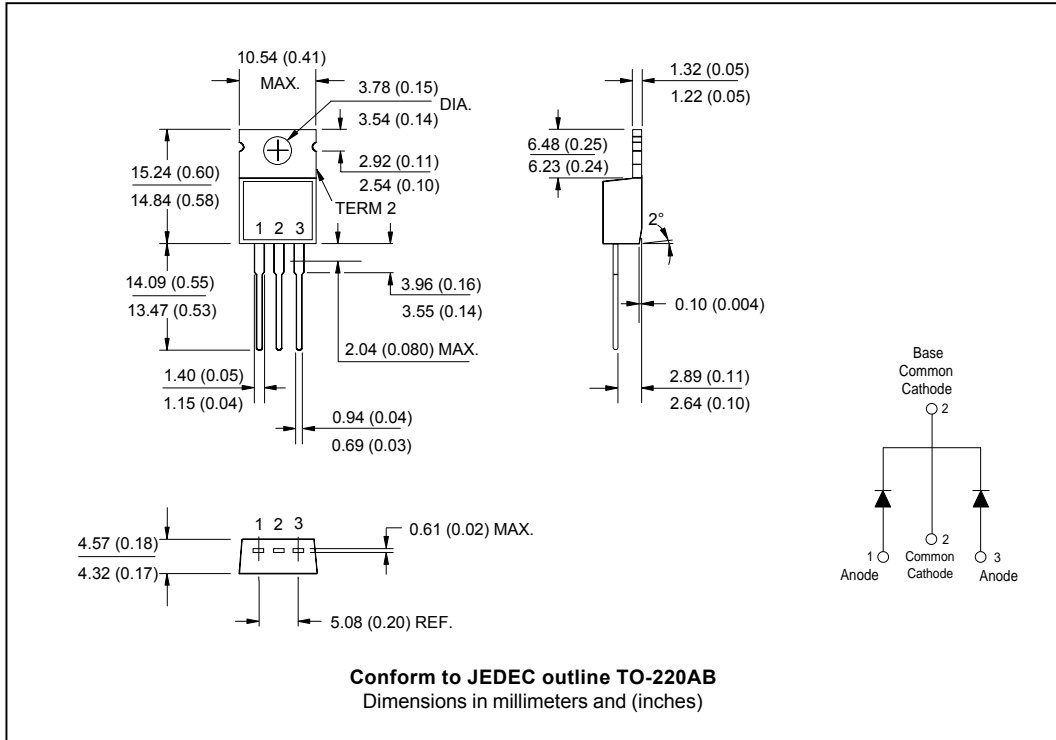

Fig. 7 - Max. Non-Repetitive Surge Current (Per Leg)

- (2) Formula used: $T_C = T_J - (P_d + P_{d_{REV}}) \times R_{thJC}$;
 $P_d = \text{Forward Power Loss} = I_{F(AV)} \times V_{FM} @ (I_{F(AV)} / D)$ (see Fig. 6);
 $P_{d_{REV}} = \text{Inverse Power Loss} = V_{R1} \times I_R (1 - D)$; $I_R @ V_{R1} = 80\% \text{ rated } V_R$

Outline Table



Ordering Information Table

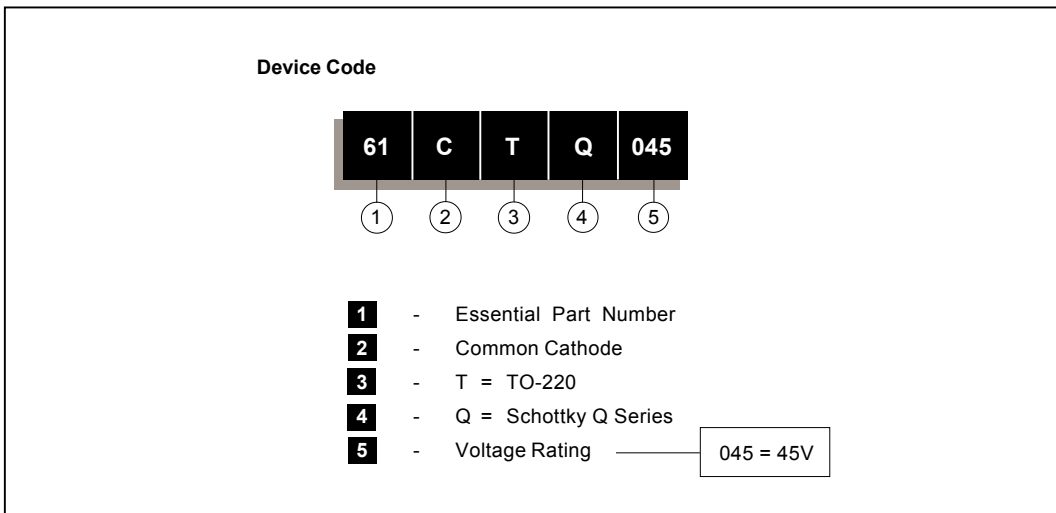

61CTQ045

Bulletin PD-20638 rev. A 12/01

International
IOR Rectifier

Data and specifications subject to change without notice.
This product has been designed and qualified for Industrial Level.
Qualification Standards can be found on IR's Web site.

International
IOR Rectifier

IR WORLD HEADQUARTERS: 233 Kansas St., El Segundo, California 90245, USA Tel: (310) 252-7105
TAC Fax: (310) 252-7309
Visit us at www.irf.com for sales contact information. 12/01

This datasheet has been download from:

www.datasheetcatalog.com

Datasheets for electronics components.