

- Logic-Level Gate Drive
- Advanced Process Technology
- Dynamic dv/dt Rating
- 175°C Operating Temperature
- Fast Switching
- Fully Avalanche Rated

Description

Fifth Generation HEXFETs from International Rectifier utilize advanced processing techniques to achieve extremely low on-resistance per silicon area. This benefit, combined with the fast switching speed and ruggedized device design that HEXFET Power MOSFETs are well known for, provides the designer with an extremely efficient and reliable device for use in a wide variety of applications.

The TO-220 package is universally preferred for all commercial-industrial applications at power dissipation levels to approximately 50 watts. The low thermal resistance and low package cost of the TO-220 contribute to its wide acceptance throughout the industry.

HEXFET® Power MOSFET

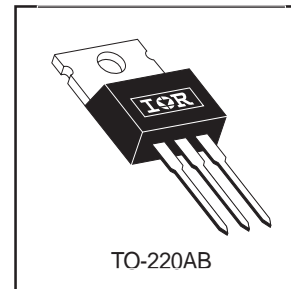
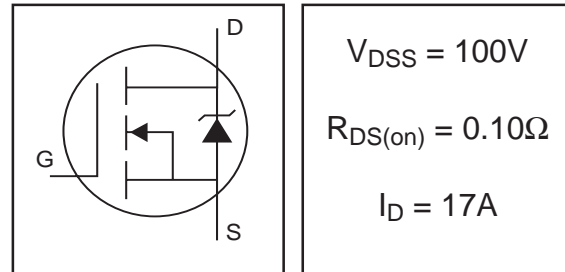

Absolute Maximum Ratings

	Parameter	Max.	Units
$I_D @ T_C = 25^\circ\text{C}$	Continuous Drain Current, $V_{GS} @ 10\text{V}$	17	A
$I_D @ T_C = 100^\circ\text{C}$	Continuous Drain Current, $V_{GS} @ 10\text{V}$	12	
I_{DM}	Pulsed Drain Current ①	60	
$P_D @ T_C = 25^\circ\text{C}$	Power Dissipation	79	W
	Linear Derating Factor	0.53	W/°C
V_{GS}	Gate-to-Source Voltage	± 16	V
E_{AS}	Single Pulse Avalanche Energy②	150	mJ
I_{AR}	Avalanche Current①	9.0	A
E_{AR}	Repetitive Avalanche Energy①	7.9	mJ
dv/dt	Peak Diode Recovery dv/dt ③	5.0	V/ns
T_J	Operating Junction and	-55 to + 175	°C
T_{STG}	Storage Temperature Range		
	Soldering Temperature, for 10 seconds		
	Mounting torque, 6-32 or M3 srew	10 lbf•in (1.1N•m)	

Thermal Resistance

	Parameter	Typ.	Max.	Units
$R_{\theta JC}$	Junction-to-Case	—	1.9	°C/W
$R_{\theta CS}$	Case-to-Sink, Flat, Greased Surface	0.50	—	
$R_{\theta JA}$	Junction-to-Ambient	—	62	

Electrical Characteristics @ $T_J = 25^\circ\text{C}$ (unless otherwise specified)

	Parameter	Min.	Typ.	Max.	Units	Conditions
$V_{(BR)DSS}$	Drain-to-Source Breakdown Voltage	100	—	—	V	$V_{GS} = 0V, I_D = 250\mu A$
$\Delta V_{(BR)DSS}/\Delta T_J$	Breakdown Voltage Temp. Coefficient	—	0.122	—	V/ $^\circ\text{C}$	Reference to $25^\circ\text{C}, I_D = 1\text{mA}$
$R_{DS(on)}$	Static Drain-to-Source On-Resistance	—	—	0.100	Ω	$V_{GS} = 10V, I_D = 9.0A$ ④
		—	—	0.120		$V_{GS} = 5.0V, I_D = 9.0A$ ④
		—	—	0.150		$V_{GS} = 4.0V, I_D = 8.0A$ ④
$V_{GS(th)}$	Gate Threshold Voltage	1.0	—	2.0	V	$V_{DS} = V_{GS}, I_D = 250\mu A$
g_{fs}	Forward Transconductance	7.7	—	—	S	$V_{DS} = 25V, I_D = 9.0A$
I_{DSS}	Drain-to-Source Leakage Current	—	—	25	μA	$V_{DS} = 100V, V_{GS} = 0V$
		—	—	250		$V_{DS} = 80V, V_{GS} = 0V, T_J = 150^\circ\text{C}$
I_{GSS}	Gate-to-Source Forward Leakage	—	—	100	nA	$V_{GS} = 16V$
	Gate-to-Source Reverse Leakage	—	—	-100		$V_{GS} = -16V$
Q_g	Total Gate Charge	—	—	34	nC	$I_D = 9.0A$
Q_{gs}	Gate-to-Source Charge	—	—	4.8		$V_{DS} = 80V$
Q_{gd}	Gate-to-Drain ("Miller") Charge	—	—	20		$V_{GS} = 5.0V$, See Fig. 6 and 13 ④
$t_{d(on)}$	Turn-On Delay Time	—	7.2	—		ns
t_r	Rise Time	—	53	—	$I_D = 9.0A$	
$t_{d(off)}$	Turn-Off Delay Time	—	30	—	$R_G = 6.0\Omega, V_{GS} = 5.0V$	
t_f	Fall Time	—	26	—	$R_D = 5.5\Omega$, See Fig. 10 ④	
L_D	Internal Drain Inductance	—	4.5	—	nH	Between lead, 6mm (0.25in.) from package and center of die contact
L_S	Internal Source Inductance	—	7.5	—		
C_{iss}	Input Capacitance	—	800	—	pF	$V_{GS} = 0V$
C_{oss}	Output Capacitance	—	160	—		$V_{DS} = 25V$
C_{rss}	Reverse Transfer Capacitance	—	90	—		$f = 1.0\text{MHz}$, See Fig. 5

Source-Drain Ratings and Characteristics

	Parameter	Min.	Typ.	Max.	Units	Conditions
I_S	Continuous Source Current (Body Diode)	—	—	17	A	MOSFET symbol showing the integral reverse p-n junction diode.
I_{SM}	Pulsed Source Current (Body Diode) ①⑥	—	—	60		
V_{SD}	Diode Forward Voltage	—	—	1.3	V	$T_J = 25^\circ\text{C}, I_S = 9.0A, V_{GS} = 0V$ ④
t_{rr}	Reverse Recovery Time	—	140	210	ns	$T_J = 25^\circ\text{C}, I_F = 9.0A$
Q_{rr}	Reverse Recovery Charge	—	740	1100	nC	$di/dt = 100A/\mu s$ ④
t_{on}	Forward Turn-On Time	Intrinsic turn-on time is negligible (turn-on is dominated by L_S+L_D)				

Notes:

- ① Repetitive rating; pulse width limited by max. junction temperature. (See fig. 11)
- ② Starting $T_J = 25^\circ\text{C}, L = 3.7\text{mH}$
 $R_G = 25\Omega, I_{AS} = 9.0A$. (See Figure 12)

③ $I_{SD} \leq 9.0A, di/dt \leq 540A/\mu s, V_{DD} \leq V_{(BR)DSS}, T_J \leq 175^\circ\text{C}$

④ Pulse width $\leq 300\mu s$; duty cycle $\leq 2\%$

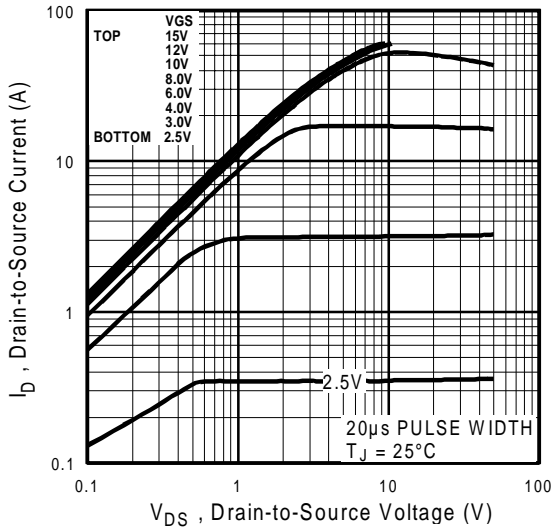

Fig 1. Typical Output Characteristics

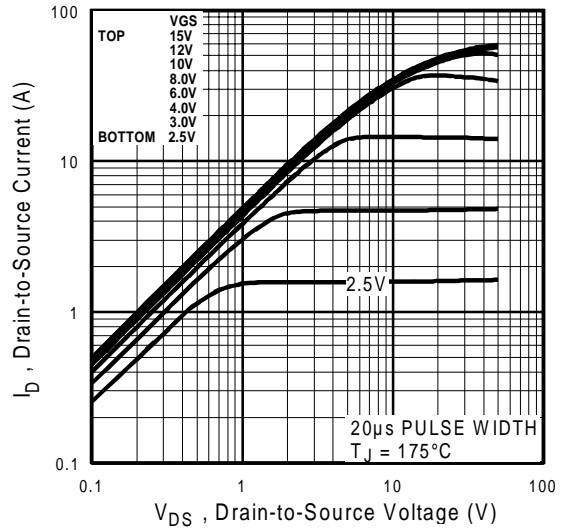

Fig 2. Typical Output Characteristics

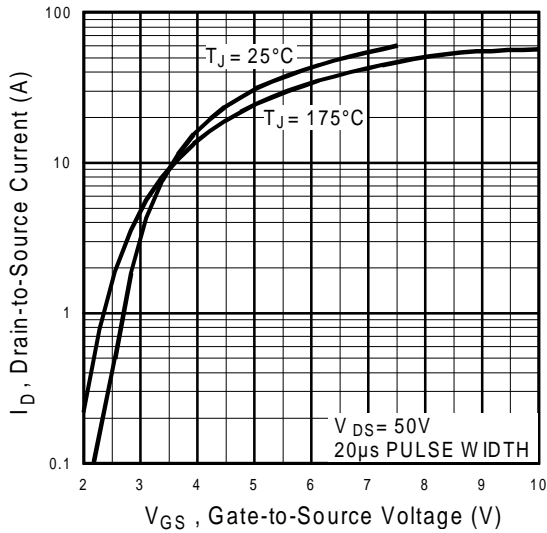

Fig 3. Typical Transfer Characteristics

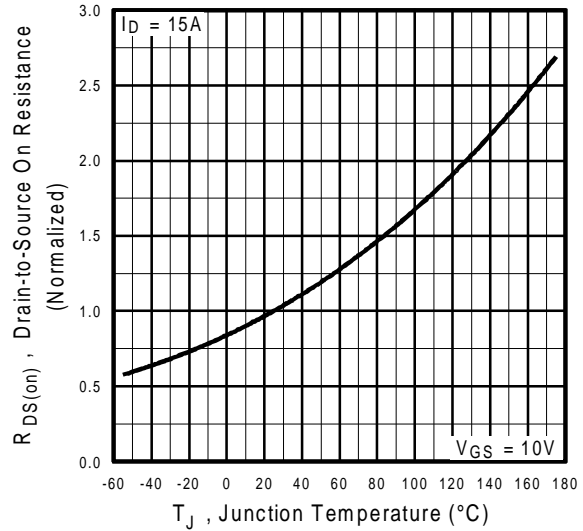

Fig 4. Normalized On-Resistance Vs. Temperature

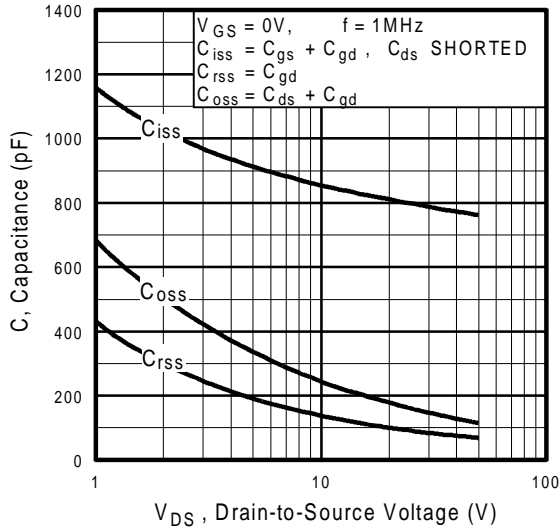

Fig 5. Typical Capacitance Vs. Drain-to-Source Voltage

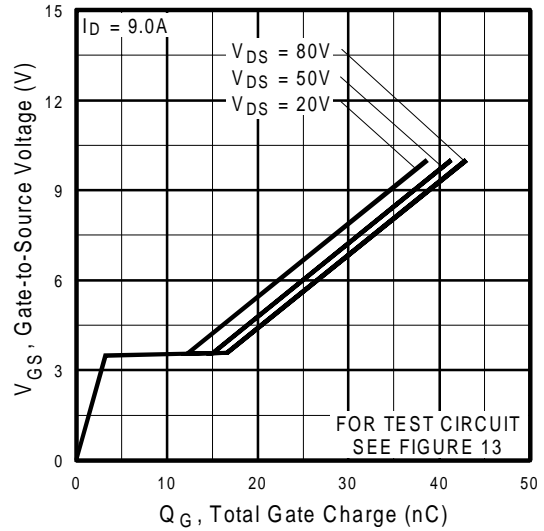

Fig 6. Typical Gate Charge Vs. Gate-to-Source Voltage

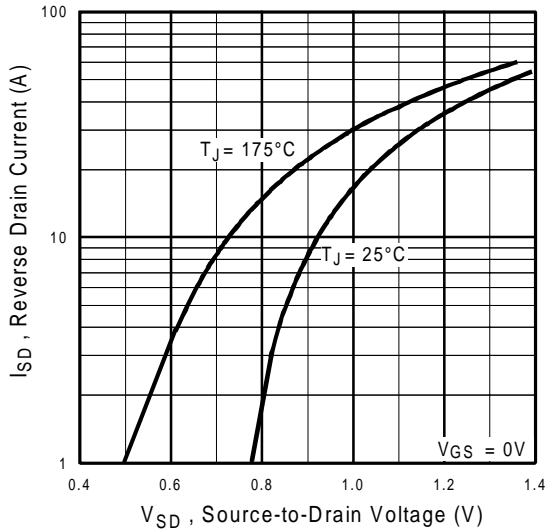

Fig 7. Typical Source-Drain Diode Forward Voltage

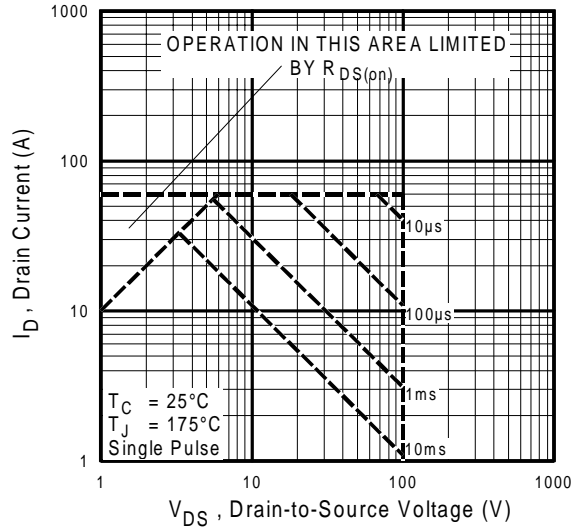

Fig 8. Maximum Safe Operating Area

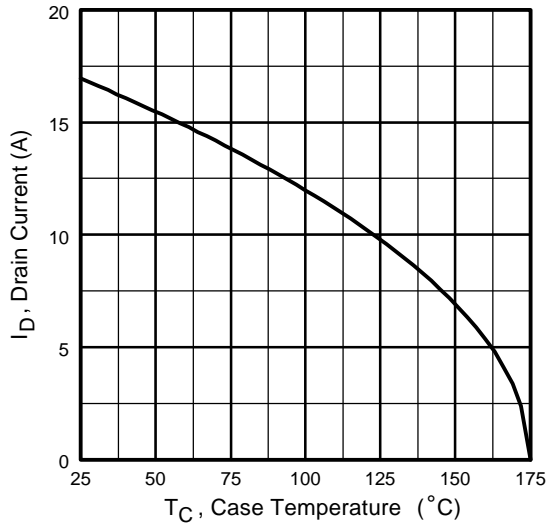

Fig 9. Maximum Drain Current Vs. Case Temperature

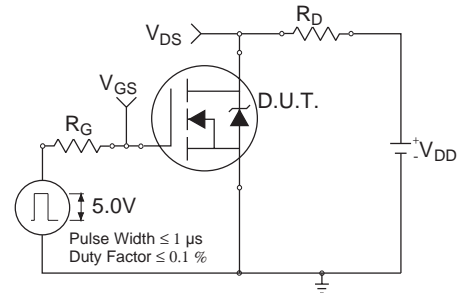

Fig 10a. Switching Time Test Circuit

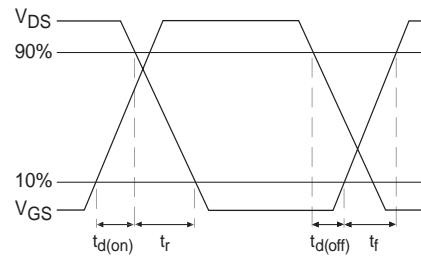

Fig 10b. Switching Time Waveforms

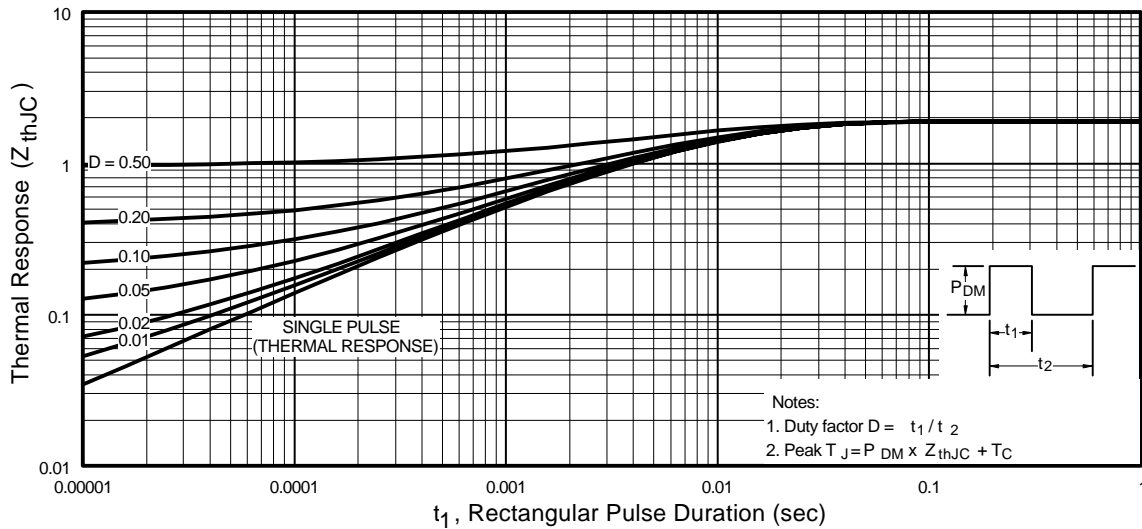

Fig 11. Maximum Effective Transient Thermal Impedance, Junction-to-Case

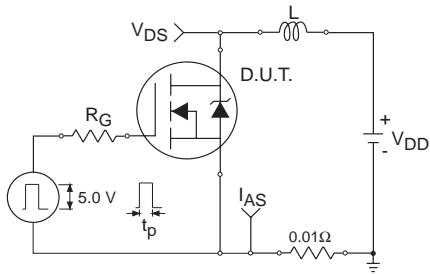

Fig 12a. Unclamped Inductive Test Circuit

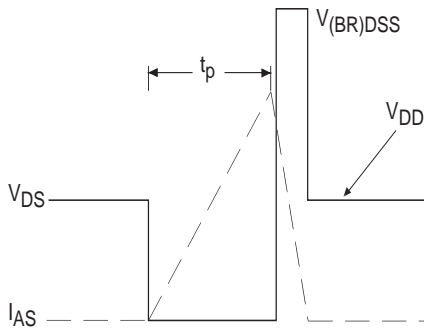

Fig 12b. Unclamped Inductive Waveforms

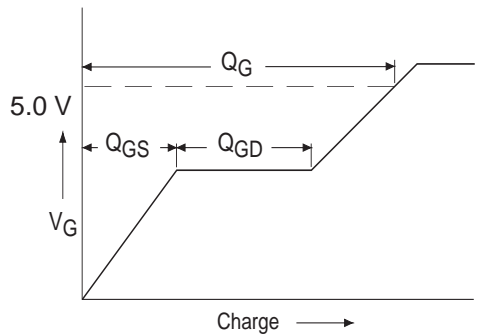

Fig 13a. Basic Gate Charge Waveform

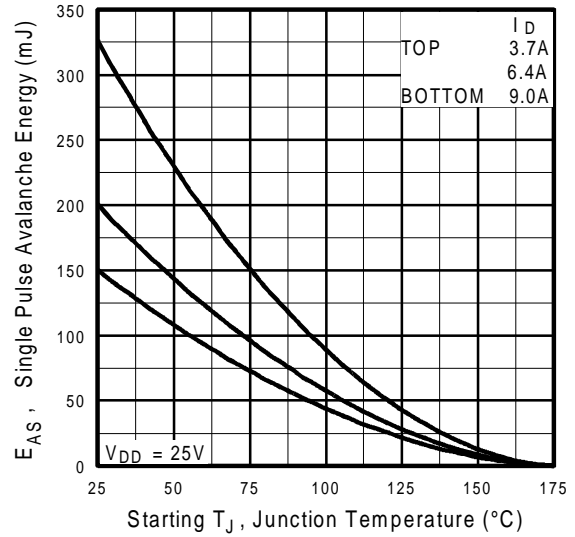

Fig 12c. Maximum Avalanche Energy Vs. Drain Current

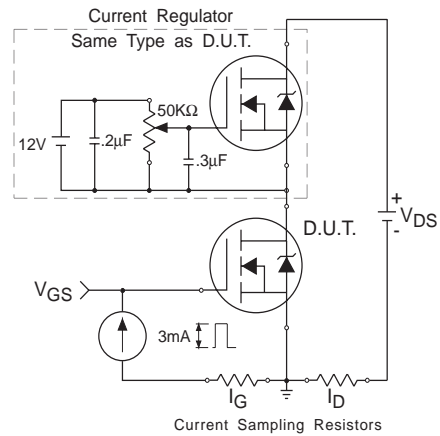
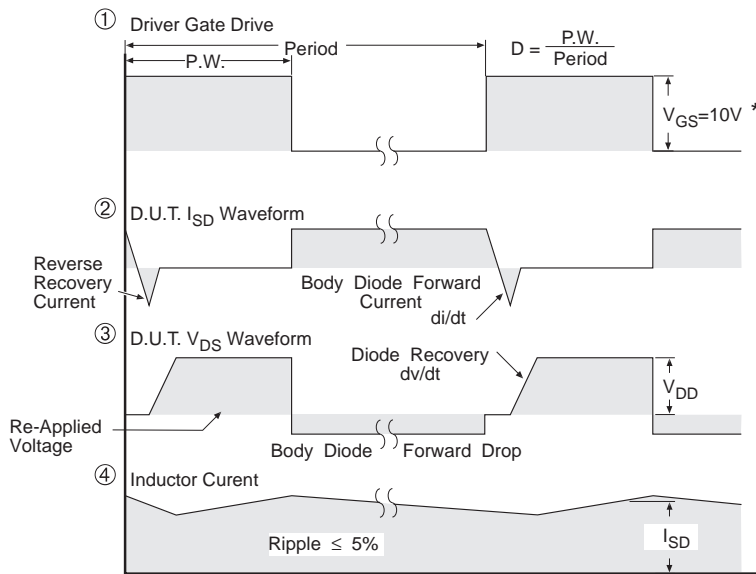
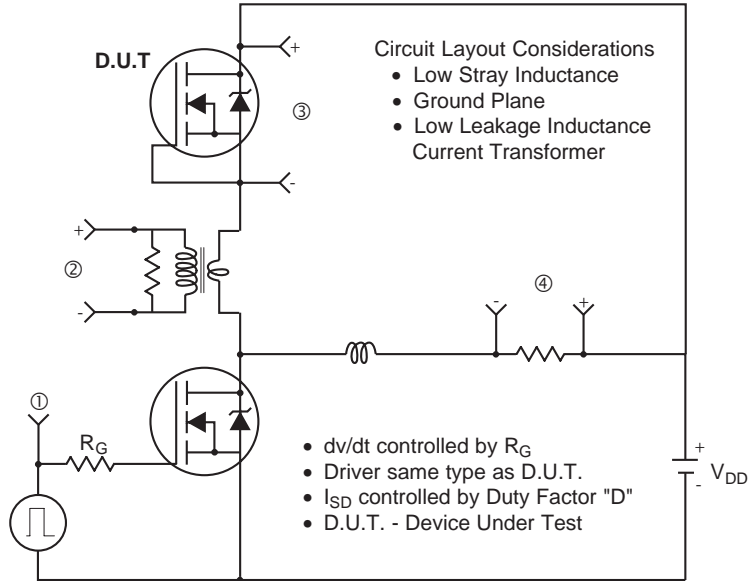

Fig 13b. Gate Charge Test Circuit

Peak Diode Recovery dv/dt Test Circuit



* $V_{GS} = 5V$ for Logic Level Devices

Fig 14. For N-Channel HEXFETS

TO-220AB Package Outline

Dimensions are shown in millimeters (inches)

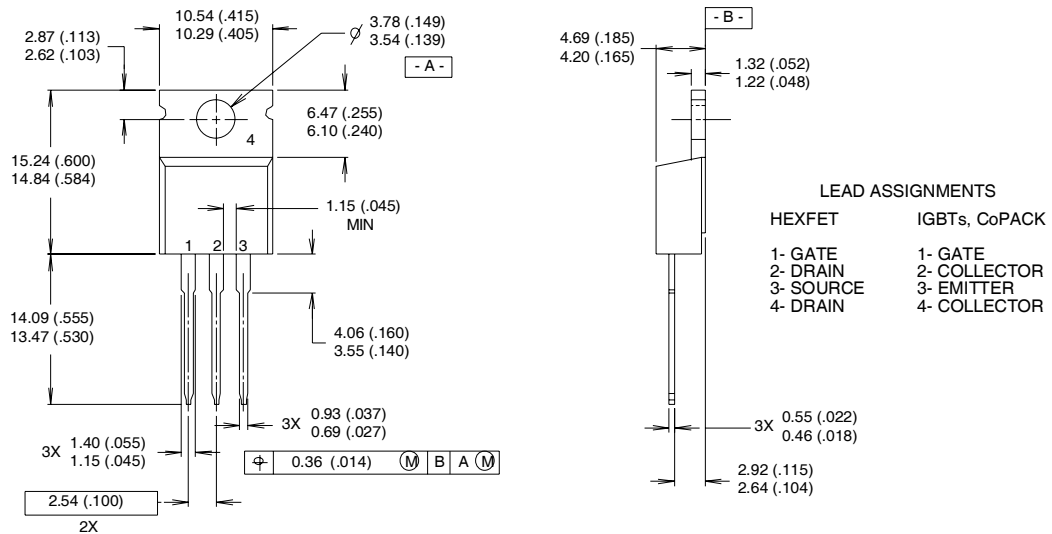

NOTES:

- 1 DIMENSIONING & TOLERANCING PER ANSI Y14.5M, 1982.
- 2 CONTROLLING DIMENSION : INCH
- 3 OUTLINE CONFORMS TO JEDEC OUTLINE TO-220AB.
- 4 HEATSINK & LEAD MEASUREMENTS DO NOT INCLUDE BURRS.

TO-220AB Part Marking Information

EXAMPLE: THIS IS AN IRF1010
 LOT CODE 1789
 ASSEMBLED ON WW 19, 1997
 IN THE ASSEMBLY LINE 'C'
Note: "P" in assembly line
 position indicates "Lead-Free"

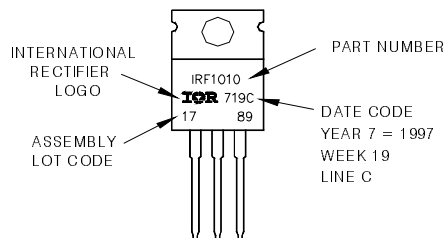

For GB Production

EXAMPLE: THIS IS AN IRF1010
 LOT CODE 1789
 ASSEMBLED ON WW 19, 1997
 IN THE ASSEMBLY LINE 'C'

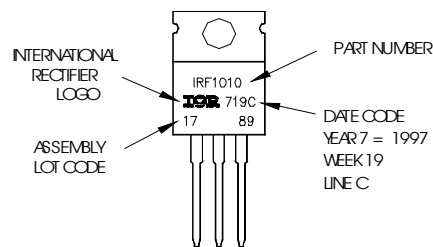

TO-220AB package is not recommended for Surface Mount Application.

Data and specifications subject to change without notice.

This datasheet has been download from:

www.datasheetcatalog.com

Datasheets for electronics components.