

FAIRCHILD

A Schlumberger Company

IRF510-513

MTP4N08/4N10

N-Channel Power MOSFETs,
5.5 A, 60-100 V

Power And Discrete Division

T-39-09

T-39-11

Description

These devices are n-channel, enhancement mode, power MOSFETs designed especially for high speed applications, such as switching power supplies, converters, AC and DC motor controls, relay and solenoid drivers and other pulse circuits.

- Low $R_{DS(on)}$
- V_{GS} Rated at ± 20 V
- Silicon Gate for Fast Switching Speeds
- I_{BSS} , $V_{DS(on)}$, Specified at Elevated Temperature
- Rugged
- Low Drive Requirements
- Ease of Paralleling

TO-220AB

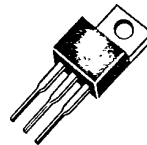

IS00010F

IRF510
IRF511
IRF512
IRF513
MTP4N08
MTP4N10

**Maximum Ratings**

Symbol	Characteristic	Rating IRF510/512 MTP4N10	Rating MTP4N08	Rating IRF511/513	Unit
V_{DSS}	Drain to Source Voltage ¹	100	80	60	V
V_{DGR}	Drain to Gate Voltage ¹ $R_{GS} = 20 \text{ k}\Omega$	100	80	60	V
V_{GS}	Gate to Source Voltage	± 20	± 20	± 20	V
T_J, T_{stg}	Operating Junction and Storage Temperatures	-55 to +150	-55 to +150	-55 to +150	$^{\circ}\text{C}$
T_L	Maximum Lead Temperature for Soldering Purposes, 1/8" From Case for 5 s	275	275	275	$^{\circ}\text{C}$

Maximum On-State Characteristics

		IRF510/511	IRF512/513	MTP4N08/10	
$R_{DS(on)}$	Static Drain-to-Source On Resistance	0.60	0.80	0.80	Ω
I_D	Drain Current				A
	Continuous at $T_C = 25^{\circ}\text{C}$	4.0	3.5	5.0	
	Continuous at $T_C = 100^{\circ}\text{C}$	2.5	2.0	3.5	
	Pulsed	16	14	14	

Maximum Thermal Characteristics

$R_{\theta JC}$	Thermal Resistance, Junction to Case	6.4	6.4	2.5	$^{\circ}\text{C}/\text{W}$
$R_{\theta JA}$	Thermal Resistance, Junction to Ambient	80	80	80	$^{\circ}\text{C}/\text{W}$
P_D	Total Power Dissipation at $T_C = 25^{\circ}\text{C}$	20	20	50	W

Notes

For information concerning connection diagram and package outline, refer to Section 7.

IRF510-513
MTP4N08/4N10

T.39.09

T.39.11

Electrical Characteristics ($T_C = 25^\circ\text{C}$ unless otherwise noted)

Symbol	Characteristic	Min	Max	Unit	Test Conditions
Off Characteristics					
$V_{(BR)DSS}$	Drain Source Breakdown Voltage ¹			V	$V_{GS} = 0\text{ V}, I_D = 250\ \mu\text{A}$
	IRF510/512/MTP4N10	100			
	MTP4N08	80			
	IRF511/513	60			
I_{DSS}	Zero Gate Voltage Drain Current		250	μA	$V_{DS} = \text{Rated } V_{DSS}, V_{GS} = 0\text{ V}$
			1000	μA	$V_{DS} = 0.8 \times \text{Rated } V_{DSS}, V_{GS} = 0\text{ V}, T_C = 125^\circ\text{C}$
I_{GSS}	Gate-Body Leakage Current		± 500	nA	$V_{GS} = \pm 20\text{ V}, V_{DS} = 0\text{ V}$
On Characteristics					
$V_{GS(th)}$	Gate Threshold Voltage			V	$I_D = 250\ \mu\text{A}, V_{DS} = V_{GS}$
	IRF510-513	2.0	4.0		
	MTP4N08/10	2.0	4.5		
$R_{DS(on)}$	Static Drain-Source On-Resistance ²			Ω	$V_{GS} = 10\text{ V}, I_D = 2.0\text{ A}$
	IRF510/511		0.60		
	IRF512/513/MTP4N08/4N10		0.80		
$V_{DS(on)}$	Drain-Source On-Voltage ²		4.8	V	$V_{GS} = 10\text{ V}; I_D = 4.0\text{ A}$
	MTP4N08/4N10		3.2	V	$V_{GS} = 10\text{ V}; I_D = 2.0\text{ A}; T_C = 100^\circ\text{C}$
g_{fs}	Forward Transconductance	1.0		S (Ω)	$V_{DS} = 10\text{ V}, I_D = 2.0\text{ A}$
Dynamic Characteristics					
C_{iss}	Input Capacitance		200	pF	$V_{DS} = 25\text{ V}, V_{GS} = 0\text{ V}$ $f = 1.0\text{ MHz}$
C_{oss}	Output Capacitance		100	pF	
C_{rss}	Reverse Transfer Capacitance		30	pF	
Switching Characteristics ($T_C = 25^\circ\text{C}$, Figures 11, 12) ³					
$t_{d(on)}$	Turn-On Delay Time		20	ns	$V_{DD} = 50\text{ V}, I_D = 2.0\text{ A}$ $V_{GS} = 10\text{ V}, R_{GEN} = 50\ \Omega$ $R_{GS} = 50\ \Omega$
t_r	Rise Time		25	ns	
$t_{d(off)}$	Turn-Off Delay Time		25	ns	
t_f	Fall Time		20	ns	
Q_g	Total Gate Charge		7.5	nC	$V_{GS} = 10\text{ V}, I_D = 8.0\text{ A}$ $V_{DD} = 40\text{ V}$

IRF510-513
MTP4N08/4N10

T-39-09

T-39-11

Electrical Characteristics (Cont.) ($T_C = 25^\circ\text{C}$ unless otherwise noted)

Symbol	Characteristic	Typ	Max	Unit	Test Conditions
Source-Drain Diode Characteristics					
V_{SD}	Diode Forward Voltage			V	$I_S = 4.0 \text{ A}; V_{GS} = 0 \text{ V}$
	IRF510/511		2.5		
	IRF512/513		2.0		$I_S = 3.5 \text{ A}; V_{GS} = 0 \text{ V}$
t_{rr}	Reverse Recovery Time	230		ns	$I_S = 4.0 \text{ A}; dI_S/dt = 25 \text{ A}/\mu\text{S}$

Notes

- $T_J = +25^\circ\text{C}$ to $+150^\circ\text{C}$
- Pulse test: Pulse width $\leq 80 \mu\text{s}$, Duty cycle $\leq 1\%$
- Switching time measurements performed on LEM TR-58 test equipment

Typical Performance Curves

Figure 1 Output Characteristics

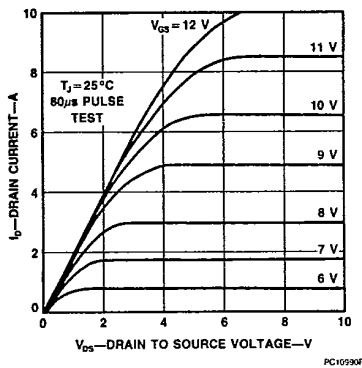

Figure 2 Static Drain to Source Resistance vs Drain Current

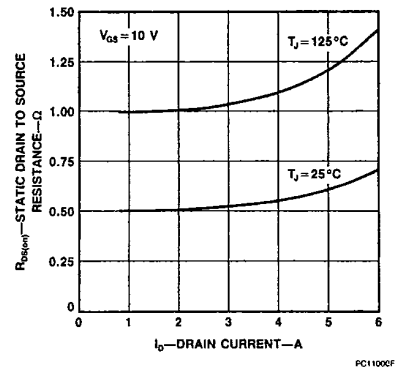

Figure 3 Transfer Characteristics

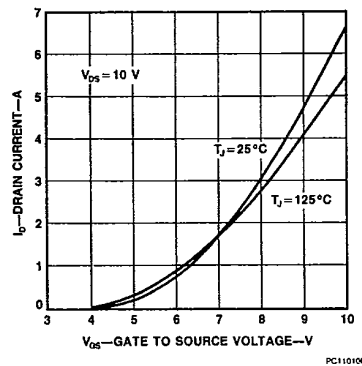
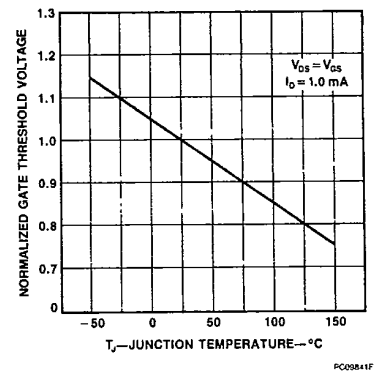

Figure 4 Temperature Variation of Gate to Source Threshold Voltage



Typical Performance Curves (Cont.)

Figure 5 Capacitance vs Drain to Source Voltage

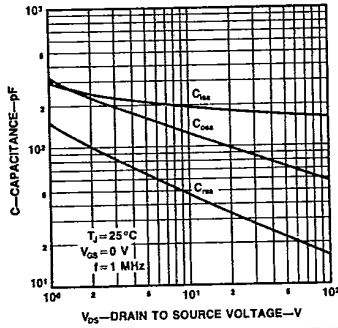

Figure 6 Gate to Source Voltage vs Total Gate Charge

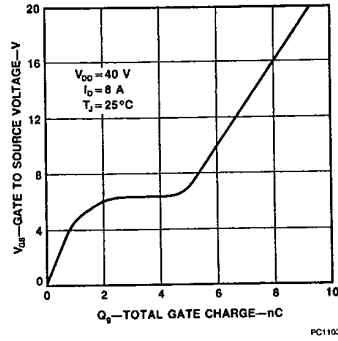

Figure 7 Forward Biased Safe Operating Area for MTP4N08/4N10

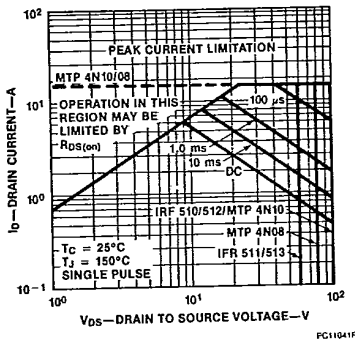

Figure 8 Transient Thermal Resistance vs Time for MTP4N08/4N10

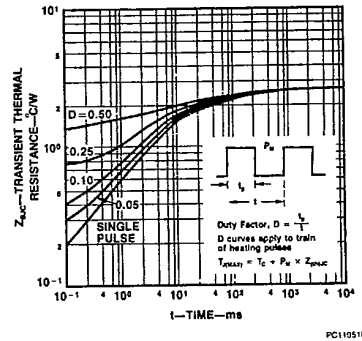

Figure 9 Forward Biased Safe Operating Area for IRF510-513

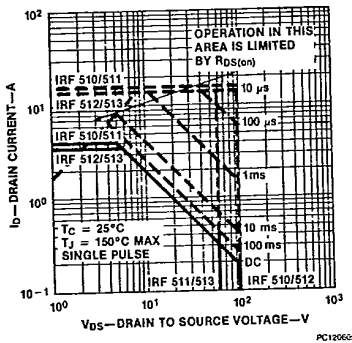
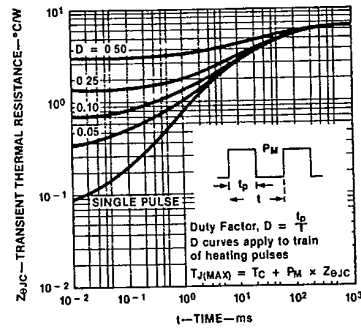

Figure 10 Transient Thermal Resistance vs Time for IRF510-513



IRF510-513
MTP4N08/4N10

T-39-09
T-39-11

Typical Electrical Characteristics

Figure 11 Switching Test Circuit

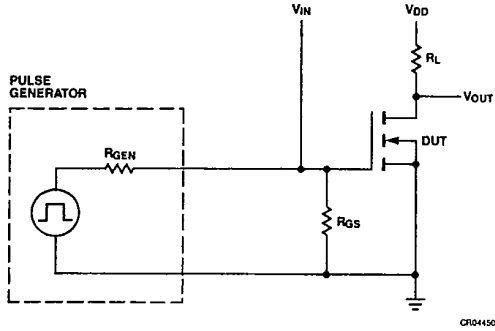
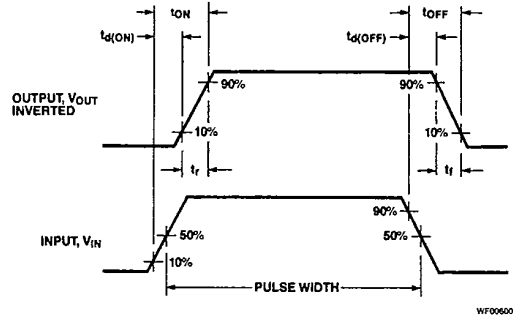

Figure 12 Switching Waveforms



This datasheet has been downloaded from:

www.DatasheetCatalog.com

Datasheets for electronic components.