

Amplifier Transistors

PNP Silicon

2N5400
2N5401*

*Motorola Preferred Device

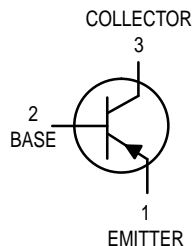

CASE 29-04, STYLE 1
TO-92 (TO-226AA)

MAXIMUM RATINGS

| Rating | Symbol | 2N5400 | 2N5401 | Unit |
|--|----------------|-------------|--------|-------------------------------|
| Collector–Emitter Voltage | V_{CEO} | 120 | 150 | Vdc |
| Collector–Base Voltage | V_{CBO} | 130 | 160 | Vdc |
| Emitter–Base Voltage | V_{EBO} | 5.0 | | Vdc |
| Collector Current — Continuous | I_C | 600 | | mAdc |
| Total Device Dissipation @ $T_A = 25^\circ\text{C}$ Derate above 25°C | P_D | 625 | 5.0 | mW mW/ $^\circ\text{C}$ |
| Total Device Dissipation @ $T_C = 25^\circ\text{C}$ Derate above 25°C | P_D | 1.5 | 12 | Watts mW/ $^\circ\text{C}$ |
| Operating and Storage Junction Temperature Range | T_J, T_{stg} | –55 to +150 | | $^\circ\text{C}$ |

THERMAL CHARACTERISTICS

| Characteristic | Symbol | Max | Unit |
|---|-----------------|------|---------------------------|
| Thermal Resistance, Junction to Ambient | $R_{\theta JA}$ | 200 | $^\circ\text{C}/\text{W}$ |
| Thermal Resistance, Junction to Case | $R_{\theta JC}$ | 83.3 | $^\circ\text{C}/\text{W}$ |

ELECTRICAL CHARACTERISTICS ($T_A = 25^\circ\text{C}$ unless otherwise noted)

| Characteristic | Symbol | Min | Max | Unit |
|----------------|--------|-----|-----|------|
|----------------|--------|-----|-----|------|

OFF CHARACTERISTICS

| | | | | |
|--|---------------|------------------|------------------------|-------------------------|
| Collector–Emitter Breakdown Voltage ⁽¹⁾ ($I_C = 1.0 \text{ mAdc}, I_E = 0$) | $V_{(BR)CEO}$ | 120 150 | — — | Vdc |
| Collector–Base Breakdown Voltage ($I_C = 100 \mu\text{Adc}, I_E = 0$) | $V_{(BR)CBO}$ | 130 160 | — — | Vdc |
| Emitter–Base Breakdown Voltage ($I_E = 10 \mu\text{Adc}, I_C = 0$) | $V_{(BR)EBO}$ | 5.0 | — | Vdc |
| Collector Cutoff Current ($V_{CB} = 100 \text{ Vdc}, I_E = 0$) ($V_{CB} = 120 \text{ Vdc}, I_E = 0$) ($V_{CB} = 100 \text{ Vdc}, I_E = 0, T_A = 100^\circ\text{C}$) ($V_{CB} = 120 \text{ Vdc}, I_E = 0, T_A = 100^\circ\text{C}$) | I_{CBO} | — — — — | 100 50 100 50 | nAdc μAdc |
| Emitter Cutoff Current ($V_{EB} = 3.0 \text{ Vdc}, I_C = 0$) | I_{EBO} | — | 50 | nAdc |

1. Pulse Test: Pulse Width = 300 μs , Duty Cycle = 2.0%.

Preferred devices are Motorola recommended choices for future use and best overall value.

2N5400 2N5401**ELECTRICAL CHARACTERISTICS** ($T_A = 25^\circ\text{C}$ unless otherwise noted) (Continued)

| Characteristic | | Symbol | Min | Max | Unit |
|--|------------------|---------------|------------|------------|------|
| ON CHARACTERISTICS(1) | | | | | |
| DC Current Gain ($I_C = 1.0 \text{ mAdc}$, $V_{CE} = 5.0 \text{ Vdc}$) ($I_C = 10 \text{ mAdc}$, $V_{CE} = 5.0 \text{ Vdc}$) ($I_C = 50 \text{ mAdc}$, $V_{CE} = 5.0 \text{ Vdc}$) | 2N5400 | h_{FE} | 30 | — | — |
| | 2N5401 | | 50 | — | — |
| | 2N5400 | | 40 | 180 | — |
| | 2N5401 | | 60 | 240 | — |
| | 2N5400 | | 40 | — | — |
| | 2N5401 | | 50 | — | — |
| Collector–Emitter Saturation Voltage ($I_C = 10 \text{ mAdc}$, $I_B = 1.0 \text{ mAdc}$) ($I_C = 50 \text{ mAdc}$, $I_B = 5.0 \text{ mAdc}$) | | $V_{CE(sat)}$ | — | 0.2 0.5 | Vdc |
| Base–Emitter Saturation Voltage ($I_C = 10 \text{ mAdc}$, $I_B = 1.0 \text{ mAdc}$) ($I_C = 50 \text{ mAdc}$, $I_B = 5.0 \text{ mAdc}$) | | $V_{BE(sat)}$ | — | 1.0 1.0 | Vdc |
| SMALL–SIGNAL CHARACTERISTICS | | | | | |
| Current–Gain — Bandwidth Product ($I_C = 10 \text{ mAdc}$, $V_{CE} = 10 \text{ Vdc}$, $f = 100 \text{ MHz}$) | 2N5400 2N5401 | f_T | 100 100 | 400 300 | MHz |
| Output Capacitance ($V_{CB} = 10 \text{ Vdc}$, $I_E = 0$, $f = 1.0 \text{ MHz}$) | | C_{obo} | — | 6.0 | pF |
| Small–Signal Current Gain ($I_C = 1.0 \text{ mAdc}$, $V_{CE} = 10 \text{ Vdc}$, $f = 1.0 \text{ kHz}$) | 2N5400 2N5401 | h_{fe} | 30 40 | 200 200 | — |
| Noise Figure ($I_C = 250 \mu\text{Adc}$, $V_{CE} = 5.0 \text{ Vdc}$, $R_S = 1.0 \text{ k}\Omega$, $f = 1.0 \text{ kHz}$) | | NF | — | 8.0 | dB |

1. Pulse Test: Pulse Width = 300 μs , Duty Cycle = 2.0%.

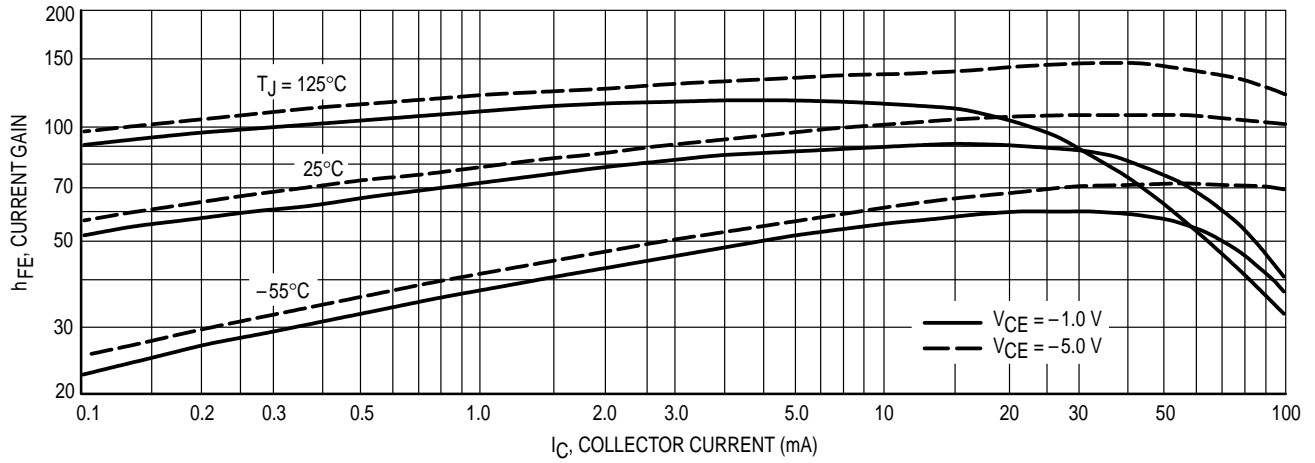

Figure 1. DC Current Gain

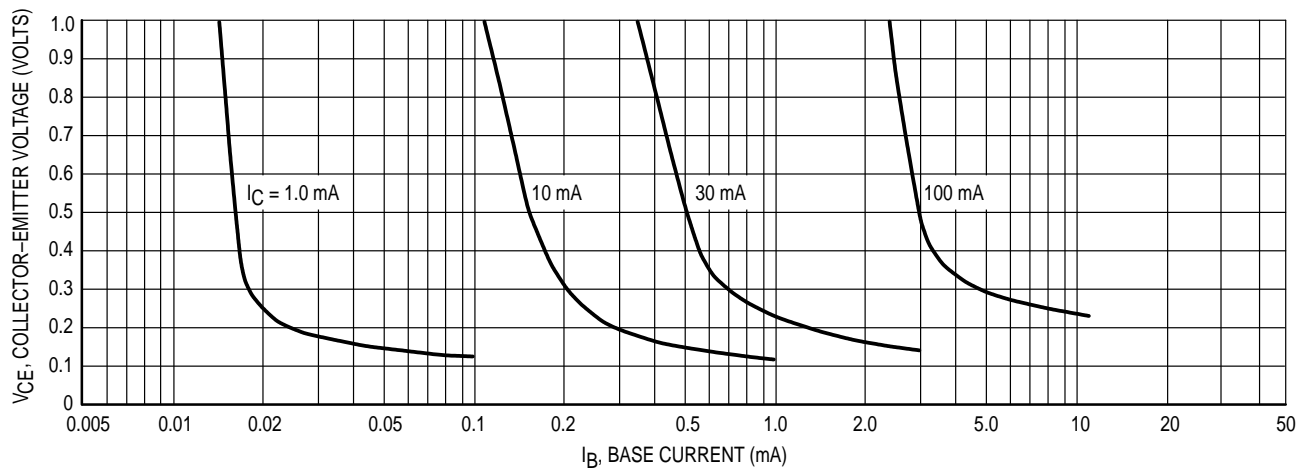

Figure 2. Collector Saturation Region

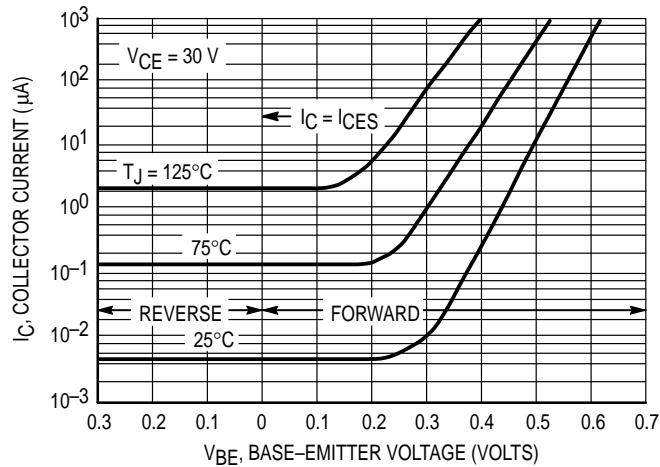

Figure 3. Collector Cut-Off Region

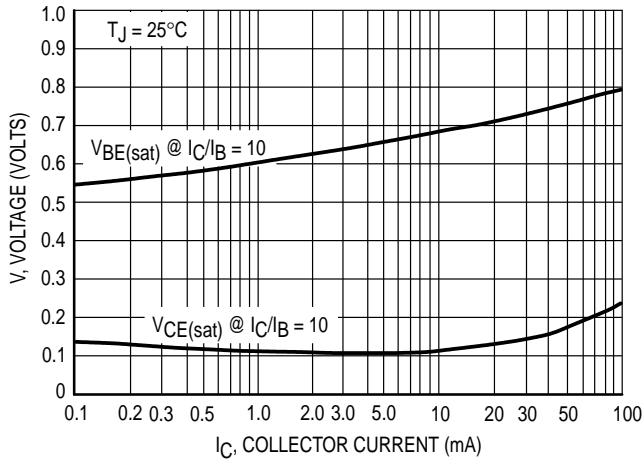

Figure 4. "On" Voltages

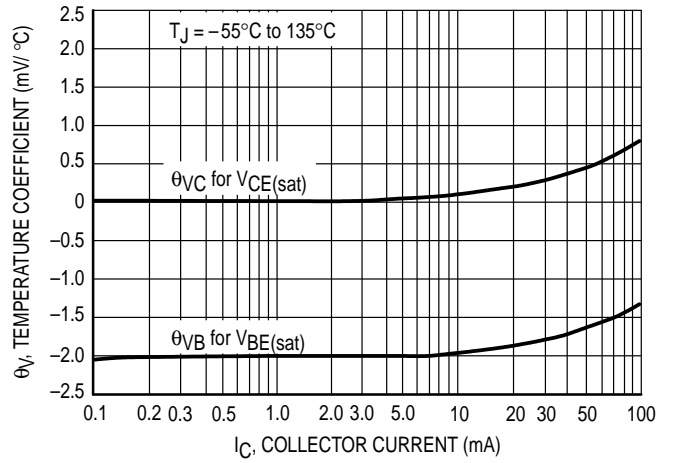

Figure 5. Temperature Coefficients

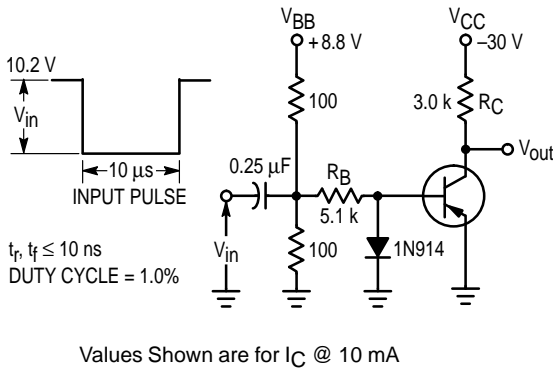

Figure 6. Switching Time Test Circuit

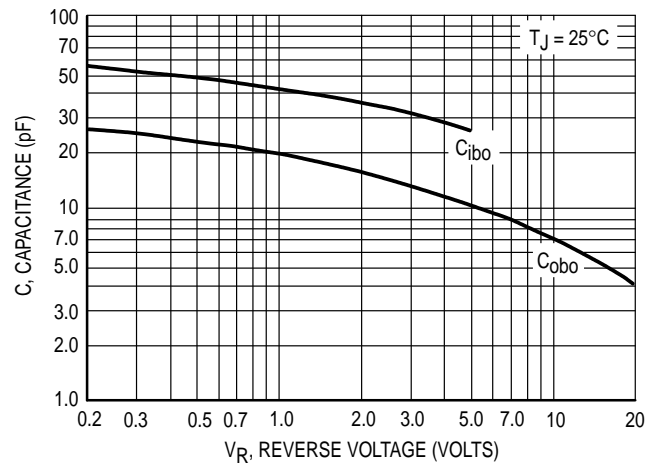

Figure 7. Capacitances

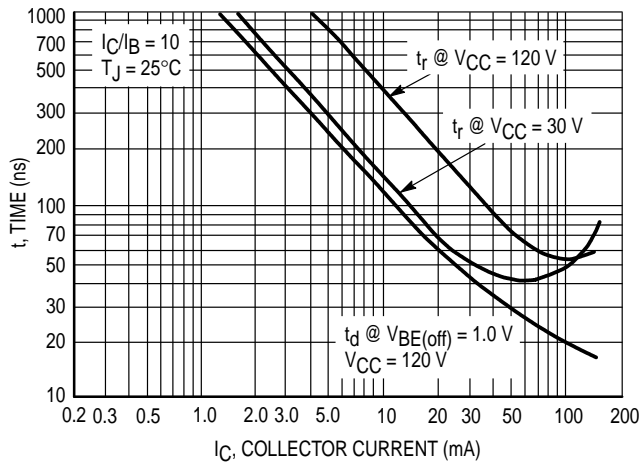

Figure 8. Turn-On Time

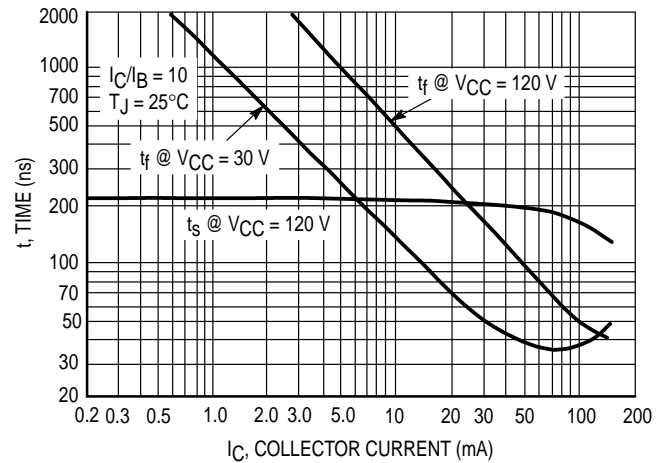

Figure 9. Turn-Off Time

PACKAGE DIMENSIONS



CASE 029-04
(TO-226AA)
ISSUE AD

- NOTES:
1. DIMENSIONING AND TOLERANCING PER ANSI Y14.5M, 1982.
 2. CONTROLLING DIMENSION: INCH.
 3. CONTOUR OF PACKAGE BEYOND DIMENSION R IS UNCONTROLLED.
 4. DIMENSION F APPLIES BETWEEN P AND L. DIMENSION D AND J APPLY BETWEEN L AND K. MINIMUM LEAD DIMENSION IS UNCONTROLLED IN P AND BEYOND DIMENSION K MINIMUM.

| DIM | INCHES | | MILLIMETERS | |
|-----|--------|-------|-------------|------|
| | MIN | MAX | MIN | MAX |
| A | 0.175 | 0.205 | 4.45 | 5.20 |
| B | 0.170 | 0.210 | 4.32 | 5.33 |
| C | 0.125 | 0.165 | 3.18 | 4.19 |
| D | 0.016 | 0.022 | 0.41 | 0.55 |
| F | 0.016 | 0.019 | 0.41 | 0.48 |
| G | 0.045 | 0.055 | 1.15 | 1.39 |
| H | 0.095 | 0.105 | 2.42 | 2.66 |
| J | 0.015 | 0.020 | 0.39 | 0.50 |
| K | 0.500 | — | 12.70 | — |
| L | 0.250 | — | 6.35 | — |
| N | 0.080 | 0.105 | 2.04 | 2.66 |
| P | — | 0.100 | — | 2.54 |
| R | 0.115 | — | 2.93 | — |
| V | 0.135 | — | 3.43 | — |

- STYLE 1:
1. EMITTER
 2. BASE
 3. COLLECTOR

Motorola reserves the right to make changes without further notice to any products herein. Motorola makes no warranty, representation or guarantee regarding the suitability of its products for any particular purpose, nor does Motorola assume any liability arising out of the application or use of any product or circuit, and specifically disclaims any and all liability, including without limitation consequential or incidental damages. "Typical" parameters can and do vary in different applications. All operating parameters, including "Typicals" must be validated for each customer application by customer's technical experts. Motorola does not convey any license under its patent rights nor the rights of others. Motorola products are not designed, intended, or authorized for use as components in systems intended for surgical implant into the body, or other applications intended to support or sustain life, or for any other application in which the failure of the Motorola product could create a situation where personal injury or death may occur. Should Buyer purchase or use Motorola products for any such unintended or unauthorized application, Buyer shall indemnify and hold Motorola and its officers, employees, subsidiaries, affiliates, and distributors harmless against all claims, costs, damages, and expenses, and reasonable attorney fees arising out of, directly or indirectly, any claim of personal injury or death associated with such unintended or unauthorized use, even if such claim alleges that Motorola was negligent regarding the design or manufacture of the part. Motorola and  are registered trademarks of Motorola, Inc. Motorola, Inc. is an Equal Opportunity/Affirmative Action Employer.

How to reach us:

USA/EUROPE: Motorola Literature Distribution;
P.O. Box 20912; Phoenix, Arizona 85036. 1-800-441-2447

JAPAN: Nippon Motorola Ltd.; Tatsumi-SPD-JLDC, Toshikatsu Otsuki,
6F Seibu-Butsuryu-Center, 3-14-2 Tatsumi Koto-Ku, Tokyo 135, Japan. 03-3521-8315

MFAX: RMFAX0@email.sps.mot.com – TOUCHTONE (602) 244-6609
INTERNET: <http://Design-NET.com>

HONG KONG: Motorola Semiconductors H.K. Ltd.; 8B Tai Ping Industrial Park,
51 Ting Kok Road, Tai Po, N.T., Hong Kong. 852-26629298

