

# IRF7807/IRF7807A

## HEXFET® Chip-Set for DC-DC Converters

- N Channel Application Specific MOSFETs
- Ideal for Mobile DC-DC Converters
- Low Conduction Losses
- Low Switching Losses

### Description

These new devices employ advanced HEXFET Power MOSFET technology to achieve an unprecedented balance of on-resistance and gate charge. The reduced conduction and switching losses make them ideal for high efficiency DC-DC Converters that power the latest generation of mobile microprocessors.

A pair of IRF7807 devices provides the best cost/performance solution for system voltages, such as 3.3V and 5V.

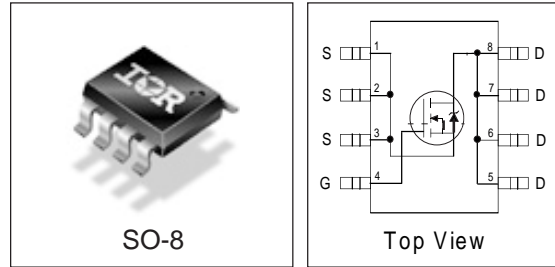

### Device Features

	IRF7807	IRF7807A
V <sub>ds</sub>	30V	30V
R <sub>ds(on)</sub>	25mΩ	25mΩ
Q <sub>g</sub>	17nC	17nC
Q <sub>sw</sub>	5.2nC	
Q <sub>oss</sub>	16.8nC	16.8nC

### Absolute Maximum Ratings

Parameter	Symbol	IRF7807	IRF7807A	Units
Drain-Source Voltage	V <sub>DS</sub>	30		V
Gate-Source Voltage	V <sub>GS</sub>	±12		
Continuous Drain or Source Current (V <sub>GS</sub> ≥ 4.5V)	I <sub>D</sub>	8.3	8.3	A
		70°C	6.6	
Pulsed Drain Current <sup>①</sup>	I <sub>DM</sub>	66	66	
Power Dissipation	P <sub>D</sub>	2.5		W
		70°C		
Junction & Storage Temperature Range	T <sub>J</sub> , T <sub>STG</sub>	-55 to 150		°C
Continuous Source Current (Body Diode) <sup>①</sup>	I <sub>S</sub>	2.5	2.5	A
Pulsed source Current	I <sub>SM</sub>	66	66	

### Thermal Resistance

Parameter	Symbol	Max.	Units
Maximum Junction-to-Ambient <sup>③</sup>	R <sub>θJA</sub>	50	°C/W

# IRF7807/IRF7807A

International  
**IR** Rectifier

Electrical Characteristics		IRF7807			IRF7807A			Units	Conditions
Parameter		Min	Typ	Max	Min	Typ	Max		
Drain-to-Source Breakdown Voltage*	$V_{(BR)DSS}$	30	-	-	30	-	-	V	$V_{GS} = 0V, I_D = 250\mu A$
Static Drain-Source on Resistance*	$R_{DS(on)}$		17	25		17	25	m $\Omega$	$V_{GS} = 4.5V, I_D = 7A$ ②
Gate Threshold Voltage*	$V_{GS(th)}$	1.0			1.0			V	$V_{DS} = V_{GS}, I_D = 250\mu A$
Drain-Source Leakage Current*	$I_{DSS}$			30			30	$\mu A$	$V_{DS} = 24V, V_{GS} = 0$
				150			150		$V_{DS} = 24V, V_{GS} = 0,$ $T_j = 100^\circ C$
Gate-Source Leakage Current*	$I_{GSS}$			$\pm 100$			$\pm 100$	nA	$V_{GS} = \pm 12V$
Total Gate Charge*	$Q_g$		12	17		12	17	nC	$V_{GS} = 5V, I_D = 7A$
Pre-Vth Gate-Source Charge	$Q_{gs1}$		2.1			2.1			$V_{DS} = 16V, I_D = 7A$
Post-Vth Gate-Source Charge	$Q_{gs2}$		0.76			0.76			
Gate to Drain Charge	$Q_{gd}$		2.9			2.9			
Switch Charge* ( $Q_{gs2} + Q_{gd}$ )	$Q_{SW}$		3.66	5.2		3.66			
Output Charge*	$Q_{oss}$		14	16.8		14	16.8		$V_{DS} = 16V, V_{GS} = 0$
Gate Resistance	$R_g$		1.2			1.2		$\Omega$	
Turn-on Delay Time	$t_d(on)$		12			12		ns	$V_{DD} = 16V$ $I_D = 7A$ $R_g = 2\Omega$ $V_{GS} = 4.5V$ Resistive Load
Rise Time	$t_r$		17			17			
Turn-off Delay Time	$t_d(off)$		25			25			
Fall Time	$t_f$		6			6			

## Source-Drain Rating & Characteristics

Parameter		Min	Typ	Max	Min	Typ	Max	Units	Conditions
Diode Forward Voltage*	$V_{SD}$			1.2			1.2	V	$I_S = 7A$ ②, $V_{GS} = 0V$
Reverse Recovery Charge④	$Q_{rr}$		80			80		nC	$di/dt = 700A/\mu s$ $V_{DS} = 16V, V_{GS} = 0V, I_S = 7A$
Reverse Recovery Charge (with Parallel Schotky)④	$Q_{rr(s)}$		50			50			$di/dt = 700A/\mu s$ (with 10BQ040) $V_{DS} = 16V, V_{GS} = 0V, I_S = 7A$

### Notes:

- ① Repetitive rating; pulse width limited by max. junction temperature.
- ② Pulse width  $\leq 300 \mu s$ ; duty cycle  $\leq 2\%$ .
- ③ When mounted on 1 inch square copper board,  $t < 10$  sec.
- ④ Typ = measured -  $Q_{oss}$
- \* Devices are 100% tested to these parameters.

## Power MOSFET Selection for DC/DC Converters

### Control FET

Special attention has been given to the power losses in the switching elements of the circuit - Q1 and Q2. Power losses in the high side switch Q1, also called the Control FET, are impacted by the  $R_{ds(on)}$  of the MOSFET, but these conduction losses are only about one half of the total losses.

Power losses in the control switch Q1 are given by;

$$P_{loss} = P_{conduction} + P_{switching} + P_{drive} + P_{output}$$

This can be expanded and approximated by;

$$P_{loss} = (I_{rms}^2 \times R_{ds(on)}) + \left( I \times \frac{Q_{gd}}{i_g} \times V_{in} \times f \right) + \left( I \times \frac{Q_{gs2}}{i_g} \times V_{in} \times f \right) + (Q_g \times V_g \times f) + \left( \frac{Q_{oss}}{2} \times V_{in} \times f \right)$$

This simplified loss equation includes the terms  $Q_{gs2}$  and  $Q_{oss}$  which are new to Power MOSFET data sheets.

$Q_{gs2}$  is a sub element of traditional gate-source charge that is included in all MOSFET data sheets. The importance of splitting this gate-source charge into two sub elements,  $Q_{gs1}$  and  $Q_{gs2}$ , can be seen from Fig 1.

$Q_{gs2}$  indicates the charge that must be supplied by the gate driver between the time that the threshold voltage has been reached (t1) and the time the drain current rises to  $I_{dmax}$  (t2) at which time the drain voltage begins to change. Minimizing  $Q_{gs2}$  is a critical factor in reducing switching losses in Q1.

$Q_{oss}$  is the charge that must be supplied to the output capacitance of the MOSFET during every switching cycle. Figure 2 shows how  $Q_{oss}$  is formed by the parallel combination of the voltage dependant (non-linear) capacitance's  $C_{ds}$  and  $C_{dg}$  when multiplied by the power supply input buss voltage.

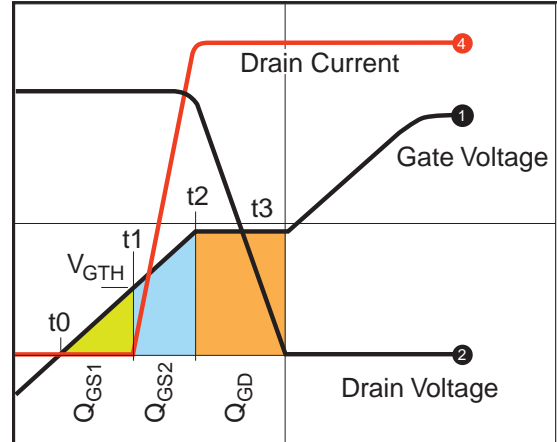

Figure 1: Typical MOSFET switching waveform

### Synchronous FET

The power loss equation for Q2 is approximated by;

$$P_{loss} = P_{conduction} + P_{drive} + P_{output}^*$$

$$P_{loss} = (I_{rms}^2 \times R_{ds(on)}) + (Q_g \times V_g \times f) + \left( \frac{Q_{oss}}{2} \times V_{in} \times f \right) + (Q_{rr} \times V_{in} \times f)$$

\*dissipated primarily in Q1.

# IRF7807/IRF7807A

International  
**IR** Rectifier

For the synchronous MOSFET Q2,  $R_{ds(on)}$  is an important characteristic; however, once again the importance of gate charge must not be overlooked since it impacts three critical areas. Under light load the MOSFET must still be turned on and off by the control IC so the gate drive losses become much more significant. Secondly, the output charge  $Q_{oss}$  and reverse recovery charge  $Q_{rr}$  both generate losses that are transferred to Q1 and increase the dissipation in that device. Thirdly, gate charge will impact the MOSFETs' susceptibility to  $Cdv/dt$  turn on.

The drain of Q2 is connected to the switching node of the converter and therefore sees transitions between ground and  $V_{in}$ . As Q1 turns on and off there is a rate of change of drain voltage  $dV/dt$  which is capacitively coupled to the gate of Q2 and can induce a voltage spike on the gate that is sufficient to turn

the MOSFET on, resulting in shoot-through current. The ratio of  $Q_{gd}/Q_{gs1}$  must be minimized to reduce the potential for  $Cdv/dt$  turn on.

Spice model for IRF7807 can be downloaded in machine readable format at [www.irf.com](http://www.irf.com).

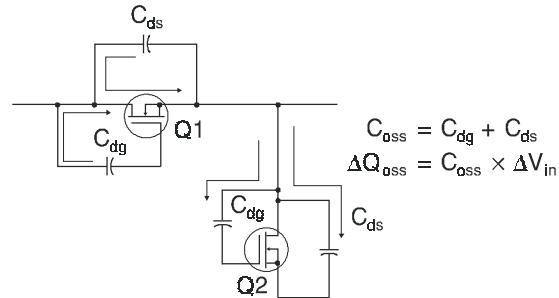

Figure 2:  $Q_{oss}$  Characteristic

## Typical Mobile PC Application

The performance of these new devices has been tested in circuit and correlates well with performance predictions generated by the system models. An advantage of this new technology platform is that the MOSFETs it produces are suitable for both control FET and synchronous FET applications. This has been demonstrated with the 3.3V and 5V converters. (Fig 3 and Fig 4). In these applications the same MOSFET IRF7807 was used for both the control FET (Q1) and the synchronous FET (Q2). This provides a highly effective cost/performance solution.

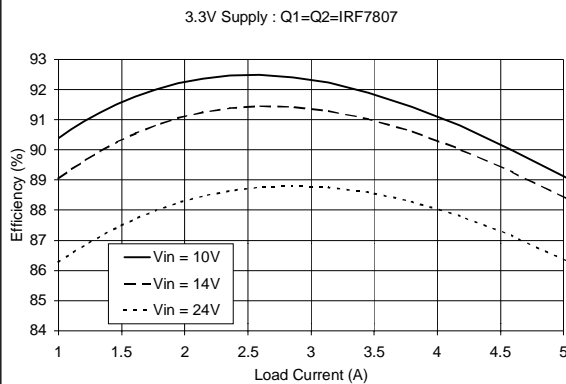

Figure 3

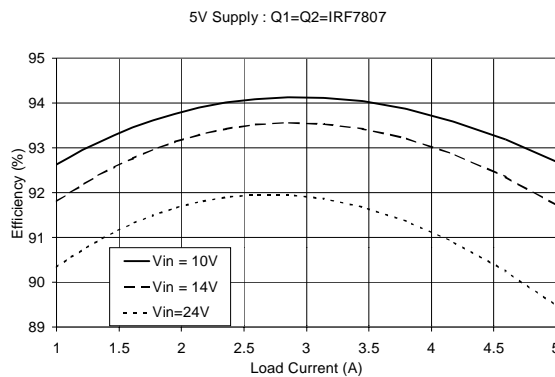
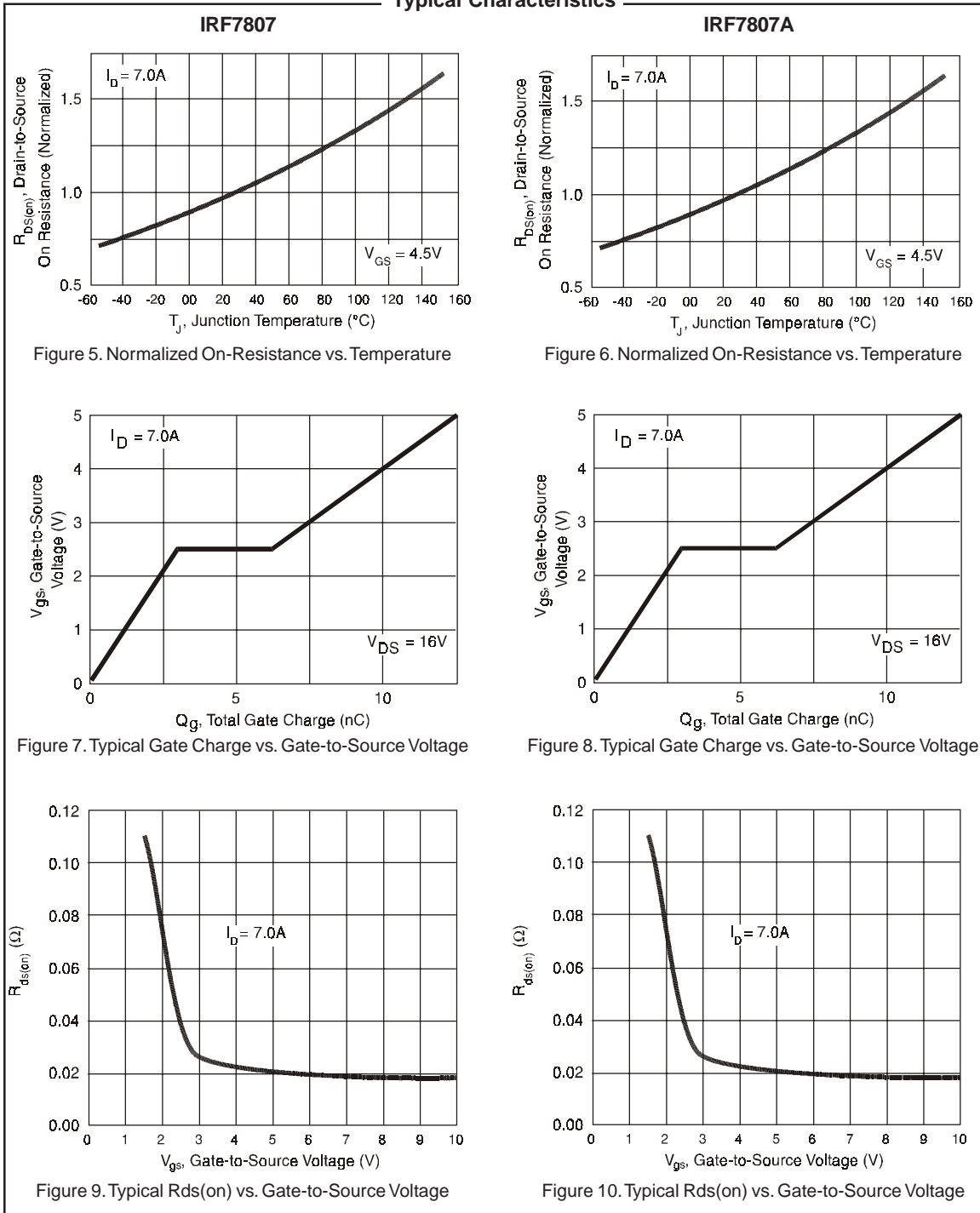
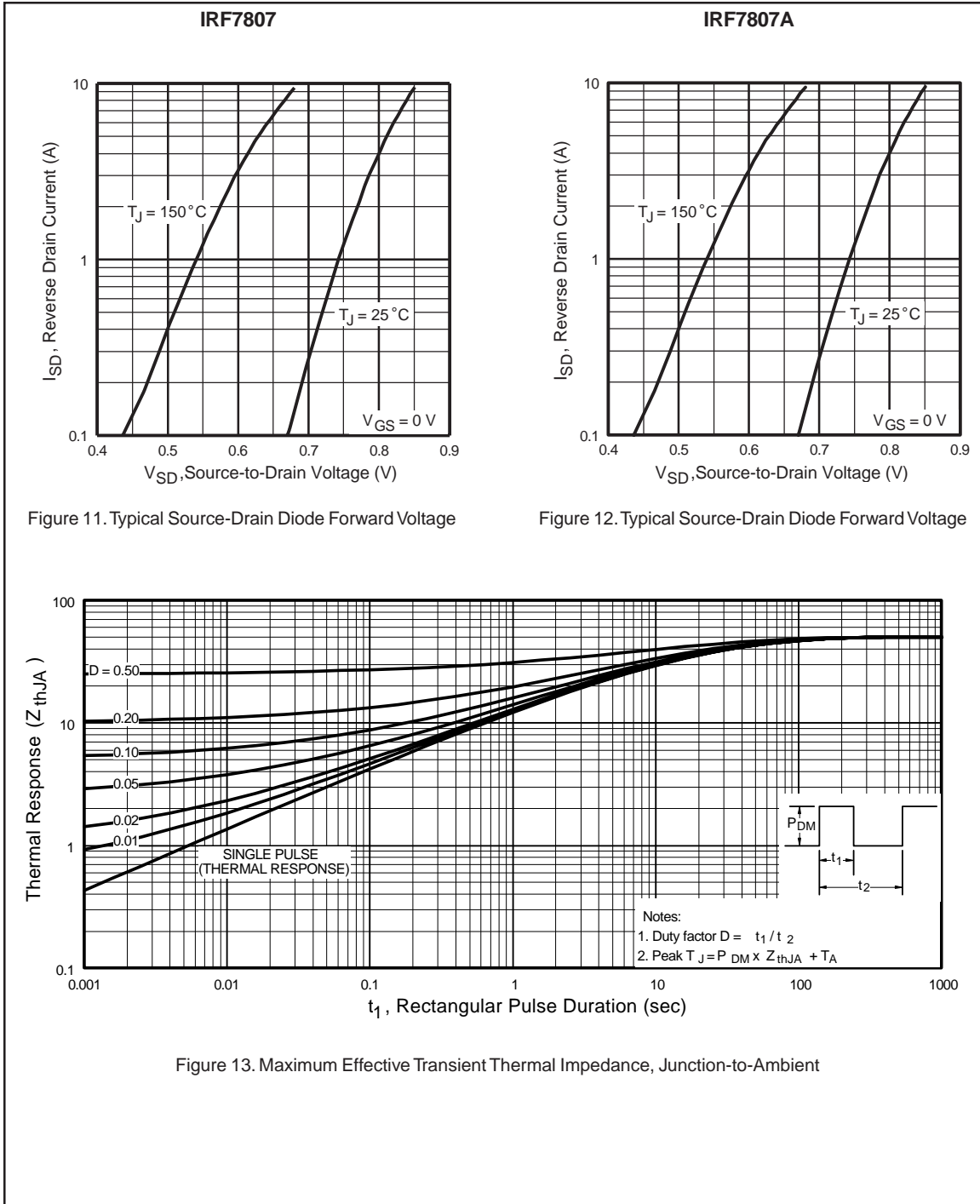

Figure 4

## Typical Characteristics





## Package Outline SO-8 Outline

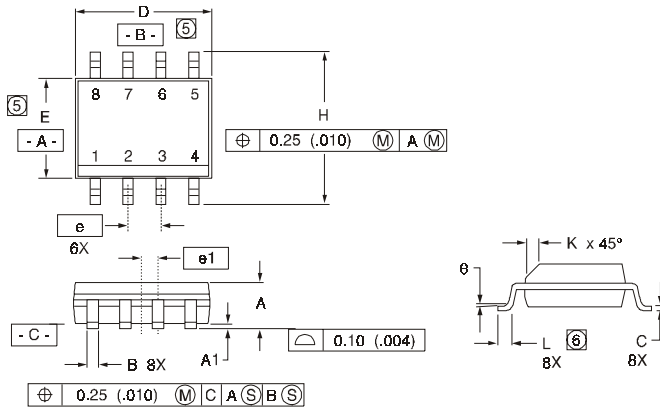

DIM	INCHES		MILLIMETERS	
	MIN	MAX	MIN	MAX
A	.0532	.0688	1.35	1.75
A1	.0040	.0098	0.10	0.25
B	.014	.018	0.36	0.46
C	.0075	.0098	0.19	0.25
D	.189	.196	4.80	4.98
E	.150	.157	3.81	3.99
e	.050 BASIC		1.27 BASIC	
e1	.025 BASIC		0.635 BASIC	
H	.2284	.2440	5.80	6.20
K	.011	.019	0.28	0.48
L	.16	.050	0.41	1.27
$\theta$	0°	8°	0°	8°

**NOTES:**

1. DIMENSIONING AND TOLERANCING PER ANSI Y14.5M-1982.
2. CONTROLLING DIMENSION: INCH.
3. DIMENSIONS ARE SHOWN IN MILLIMETERS (INCHES).
4. OUTLINE CONFORMS TO JEDEC OUTLINE MS-012AA.
5. DIMENSION DOES NOT INCLUDE MOLD PROTRUSIONS  
MOLD PROTRUSIONS NOT TO EXCEED 0.25 (.006).
6. DIMENSIONS IS THE LENGTH OF LEAD FOR SOLDERING TO A SUBSTRATE..

**RECOMMENDED FOOTPRINT**

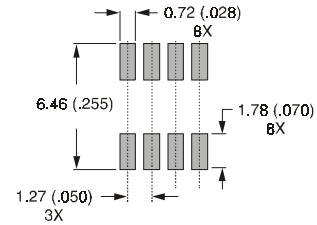

## Part Marking Information SO-8

EXAMPLE: THIS IS AN IRF7101

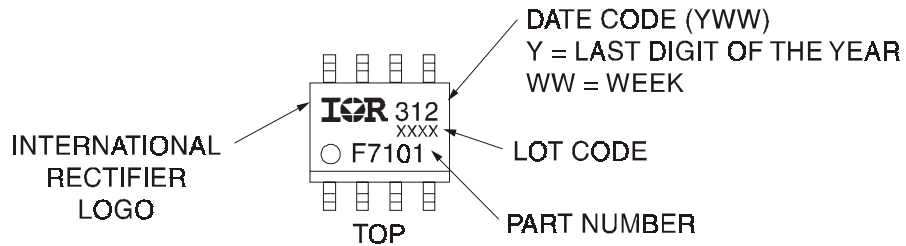

# IRF7807/IRF7807A

International  
**IR** Rectifier

## Tape & Reel Information

SO-8

Dimensions are shown in millimeters (inches)

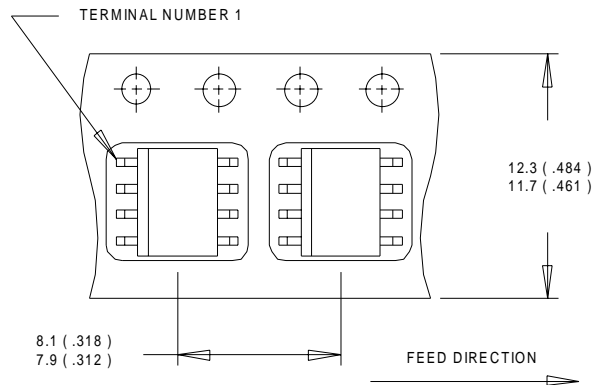

### NOTES:

1. CONTROLLING DIMENSION : MILLIMETER.
2. ALL DIMENSIONS ARE SHOWN IN MILLIMETERS(INCHES).
3. OUTLINE CONFORMS TO EIA-481 & EIA-541.

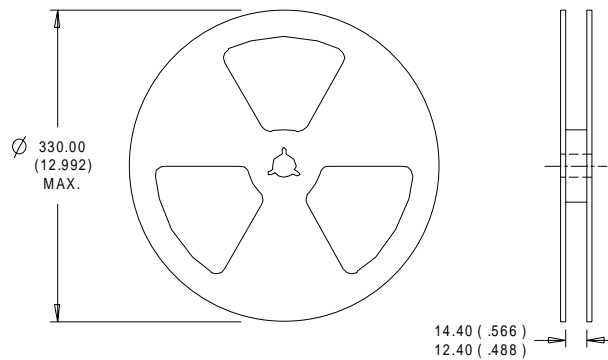

### NOTES:

1. CONTROLLING DIMENSION : MILLIMETER.
2. OUTLINE CONFORMS TO EIA-481 & EIA-541.

International  
**IR** Rectifier

**IR WORLD HEADQUARTERS:** 233 Kansas St., El Segundo, California 90245, USA Tel: (310) 252-7105  
**IR EUROPEAN REGIONAL CENTRE:** 439/445 Godstone Rd, Whyteleafe, Surrey CR3 0BL, UK Tel: ++ 44 (0)20 8645 8000  
**IR CANADA:** 15 Lincoln Court, Brampton, Ontario L6T3Z2, Tel: (905) 453 2200  
**IR GERMANY:** Saalburgstrasse 157, 61350 Bad Homburg Tel: ++ 49 (0) 6172 96590  
**IR ITALY:** Via Liguria 49, 10071 Borgaro, Torino Tel: ++ 39 011 451 0111  
**IR JAPAN:** K&H Bldg., 2F, 30-4 Nishi-Ikebukuro 3-Chome, Toshima-Ku, Tokyo 171 Tel: 81 (0)3 3983 0086  
**IR SOUTHEAST ASIA:** 1 Kim Seng Promenade, Great World City West Tower, 13-11, Singapore 237994 Tel: ++ 65 (0)838 4630  
**IR TAIWAN:** 16 Fl. Suite D. 207, Sec. 2, Tun Haw South Road, Taipei, 10673 Tel: 886-(0)2 2377 9936

*Data and specifications subject to change without notice. 10/00*



This datasheet has been download from:

[www.datasheetcatalog.com](http://www.datasheetcatalog.com)

Datasheets for electronics components.