

# FILTERS

## FOR TV/VCR APPLICATIONS—HIGH SELECTIVITY

### SFT SERIES

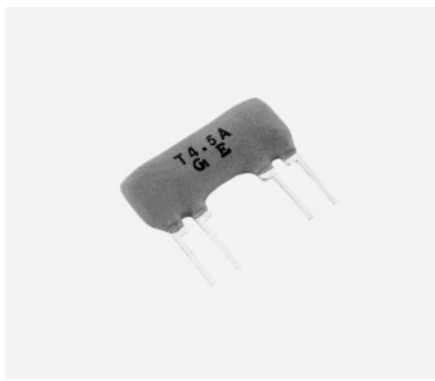

Ceramic Filter SFT Series is high selectivity filter which involves 3-element filter unit.

#### FEATURES

- Excellent shape factor
- Good performance for spurious suppression

#### DIMENSIONS: mm

<p><b>SFT</b></p> <p style="font-size: small;">① ② ③ ④</p> <p style="font-size: x-small;">( ) : EIAJ Date Code</p>	<p><b>CIRCUIT</b></p> <p style="font-size: x-small;"> <math>R_g + R_1 = R_2 = \text{Input/Output Impedance}</math>  <math>C = 10\text{pF}</math>                      (Include stray capacitance)                 </p>	<p><b>SFT5.5MA/SFT5.7MA (5.1 ~ 6.1MHz)</b></p>
--	--	--

#### SPECIFICATIONS

Part Number	Nominal Center Frequency	3dB Bandwidth (kHz) min.	20dB Bandwidth (kHz) max.	Insertion Loss (dB) max.	Stop Band Attenuation (dB) min.
SFT4.5MA	4.5MHz	±40 (±70)	370 (310)	10 (7.5)	40 (Within 4.5 $\pm 0.7$ MHz)
SFT5.5MA	5.5MHz	±50 (±85)	350 (290)	9 (6.5)	50 (Within 5.5 + 1MHz)
SFT5.74MA	5.74MHz	±50 (±85)	350 (290)	9 (6.5)	50 (Within 5.74 + 1MHz)
SFT6.0MA	6.0MHz	±50 (±85)	400 (330)	9 (5)	50 (Within 6.0 + 1MHz)
SFT6.5MA	6.5MHz	±50 (±85)	400 (330)	9 (5)	50 (Within 6.5 + 1MHz)

( ) Typical value

#### PART NUMBERING SYSTEM

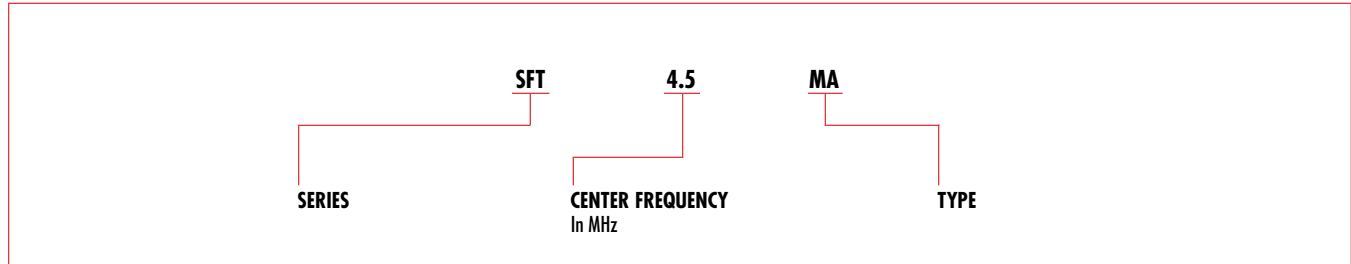

\*Applicable in North American market only. ▼Applicable in European market only.  
 For more detailed information regarding this product line in North America, consult us. To receive additional information on Murata Products call 1-800-831-9172.  
 For more detailed information regarding this product line in Europe, see Catalog No. P25E-2.

# FILTERS

## FOR TV/VCR APPLICATIONS HIGHLY ACCURATE SFSH 3.58–6.5MHz

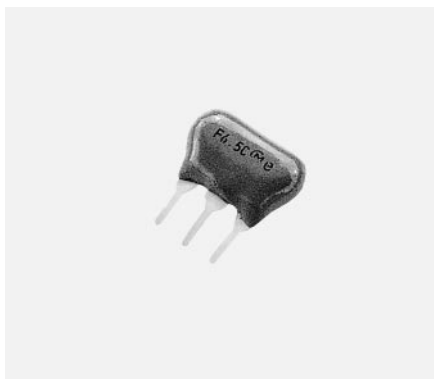

The SFSH lines of ceramic filters are high quality devices designed to address the TV/VCR/CATV/DBS markets. The SFSH lines are utilized as IF filters in virtually every type of technology currently used in the television industry.

### FEATURES

- Excellent spurious characteristics within video signal band.
- 3 types of bandwidths are prepared to respond to customer requests.
- SFSH4.5MEB2 is suitable for multiplex sound TV in America.

### DIMENSIONS: mm

<p>① INPUT ② GROUND ③ OUTPUT</p> <p>⊖ : EIAJ Date Code</p>	<h3>CIRCUIT</h3> <p><math>R_g + R_1 = R_2 = \text{Input/Output Impedance}</math>  <math>C = 10\text{pF}</math>          (including stray capacitance and input capacitance of RF Voltmeter)</p> <p>① INPUT ② GROUND ③ OUTPUT</p>	<h3>CHARACTERISTICS (TYP.)</h3>
--	--	---------------------------------

### SPECIFICATIONS

### SFSH 4.5 ~ 6.5MHz

Part Number	3dB Bandwidth (kHz) min.	20dB Bandwidth (kHz) max.	Insertion Loss (dB) max.	Spurious Response (dB) min.	Input/Output Impedance (Ω)
SFSH4.5MCB	±60 (±110)	600 (470)	6 (3.2)	30 (0 ~ 4.5MHz)	1k
SFSH5.5MCB	±60 (±115)	600 (500)	6 (3.6)	30 (0 ~ 5.5MHz)	600
SFSH6.0MCB	±60 (±115)	600 (500)	6 (4.0)	30 (0 ~ 6.0MHz)	470
SFSH6.5MCB	±70 (±115)	650 (530)	6 (3.6)	30 (0 ~ 6.5MHz)	470
SFSH4.5MDB	±70 (±130)	750 (520)	6 (3.0)	30 (0 ~ 4.5MHz)	1k
SFSH5.5MDB	±80 (±150)	750 (640)	6 (3.0)	30 (0 ~ 5.5MHz)	600
SFSH6.0MDB	±80 (±155)	750 (640)	6 (3.8)	30 (0 ~ 6.0MHz)	470
SFSH6.5MDB	±80 (±150)	800 (640)	6 (3.4)	30 (0 ~ 6.5MHz)	470
SFSH4.5MEB2	±125 (±180)	800 (740)	6 (3.0)	25 (0 ~ 4.5MHz)	1k

\*3.58 and 4.43MHz for chroma and various other frequencies for VCR are also available.

### PART NUMBERING SYSTEM

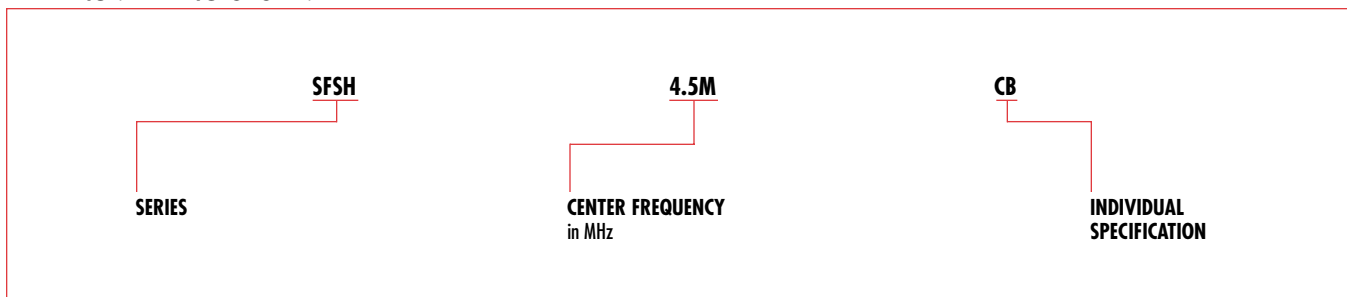

▲Applicable in North American market only. ▼Applicable in European market only.  
 For more detailed information regarding this product line in North America, see Catalog No. P-05-D. To receive additional information on Murata Products call 1-800-831-9172.  
 For more detailed information regarding this product line in Europe, see Catalog No. P25E-2.

FILTERS

# FILTERS

## TRAPS FOR TV/VCR APPLICATIONS HIGH ATTENUATION TPS□MJ/MB, TPWA, TPT SERIES

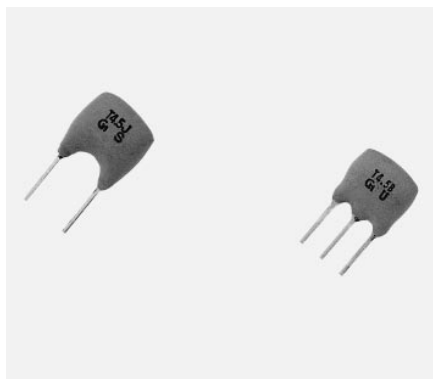

The TPS MJ/MB lines of ceramic traps are band reject filters used for video and sound IF attenuation. The 2 terminal TPS MJ Series can be used to attenuate either the sound signal in B/W receivers or the chroma signal in video. The 3 terminal TPS MB Series contains 2 trap elements on one substrate for additional attenuation. This line of traps can be used in the sound IF of CATV/VCR receivers.

### FEATURES

- TPS□MJ
  - Small size, lightweight

- High performance, high durability
- TPS□MB
  - Good performance of attenuation
  - Shape factor can be changed by the value of inductance "L"
  - 3-terminal type
- TPWA
  - Recommended for Multi standard set
- TPT
  - Good performance of attenuation
  - Space saving
  - 3-terminal type

### DIMENSIONS: mm

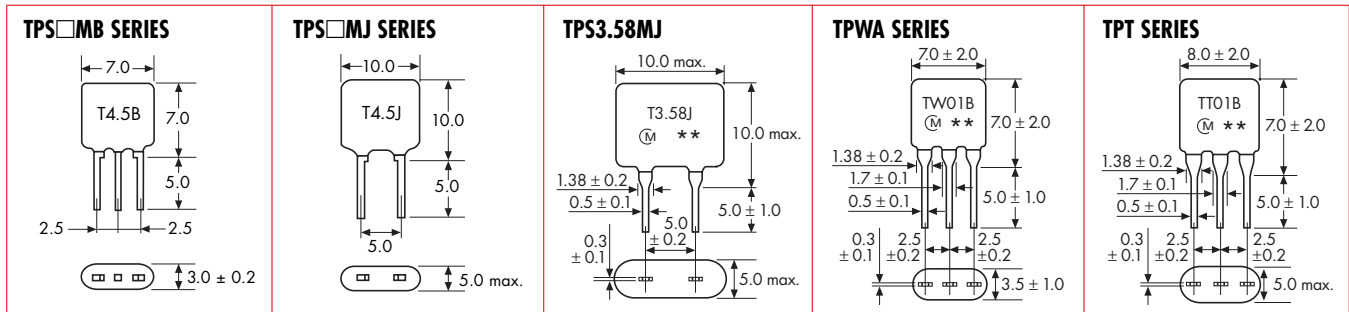

### SPECIFICATIONS

Part Number	Nominal Center Frequency (fn)	Attenuation at fn (dB) min.	20dB Attenuation Bandwidth (kHz) min.	Spurious Response (0 ~ fn) (dB) max.
*TPS4.5MJ	4.5MHz	20 (30)	30 (50)	0.5 (0)
*TPS5.5MJ	5.5MHz	20 (30)	30 (60)	0.5 (0)
*TPS6.0MJ	6.0MHz	20 (30)	40 (70)	0.5 (0)
TPS6.5MJ	6.5MHz	20 (30)	40 (90)	0.5 (0)
*TPS3.58MJ	3.58MHz	20 (27)	20 (30)	0.5 (0)
TPS4.43MJ	4.43MHz	20 (30)	40 (50)	0.5 (0)

The level at 1 MHz shall be made for a reference (0dB).

( ) Typical value

Part Number	Nominal Center Frequency (fn)	Attenuation at fn (dB) min.	30dB Attenuation Bandwidth (kHz) min.	Spurious Response (0 ~ fn) (dB) max.
*TPS4.5MB2	4.5MHz	35 (45)	50 (80)	0.5 (0)
TPS5.74MB2▼	5.742MHz	35 (45)	70 (120)	0.5 (0)
*TPS□MB	5.5 ~ 6.5MHz	35 (45)	70 (120)	0.5 (0)
TPSS.5MWA▼	5.5MHz	32 (45)	70 (130)	0.5 (0)
	5.742MHz	25 (33)	—	

The level at 1 MHz shall be made for a reference (0dB). Other frequencies (3.58, 4.43 MHz) are also available.

6.0mm height type (TPS□MB) is also available.

( ) Typical value

Part Number	Nominal Center Frequency		Attenuation at fn (dB) min.	30dB Attenuation Bandwidth (kHz) min.		Spurious Response (0 ~ 5MHz) (dB) max.
	fn <sub>1</sub>	fn <sub>2</sub>		fn <sub>1</sub>	fn <sub>2</sub>	
TPWA01B	6.0MHz	6.5MHz	30 (45)	70 (100)	70 (120)	0.5 (0)
TPWA02B	5.5MHz	6.5MHz	30 (45)	50 (80)	50 (120)	0.5 (0)
TPWA03B	5.5MHz	6.0MHz	30 (45)	50 (80)	50 (100)	0.5 (0)
TPWA04B	5.5MHz	5.742MHz	30 (45)	50 (80)	50 (100)	0.5 (0)

The hole diameter of printed circuit board should be φ1.0mm.

( ) Typical value

Part Number	Nominal Center Frequency			Attenuation at fn (dB) min.	30dB Attenuation Bandwidth (kHz) min.			Spurious Response (0 ~ 5MHz) (dB) max.
	fn <sub>1</sub>	fn <sub>2</sub>	fn <sub>3</sub>		fn <sub>1</sub>	fn <sub>2</sub>	fn <sub>3</sub>	
TPT01B	5.5MHz	6.0MHz	6.5MHz	30 (45)	50 (80)	50 (90)	50 (100)	0.5 (0)

The hole diameter of printed circuit board should be φ1.0mm.

( ) Typical value

### PART NUMBERING SYSTEM

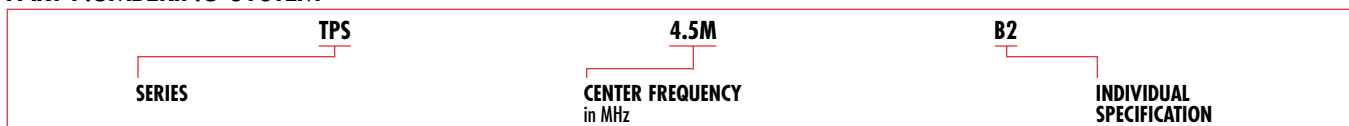

\*Available as standard through authorized Murata Electronics Distributors. \*Applicable in North American market only. \*Applicable in European market only.

For more detailed information regarding this product line in North America, see Catalog No. P-05-D. To receive additional information on Murata Products call 1-800-831-9172.

For more detailed information regarding this product line in Europe, see Catalog No. P25E-2.

# FILTERS

## DISCRIMINATORS FOR TV/VCR APPLICATIONS QUADRATURE DETECTION- CDA MC/ME 4.5-6.5MHz



The CDA MC/ME lines of ceramic discriminators are IC dependent devices used in the recovery of audio signals. The CDA MC discriminators have three terminals while the CDA ME discriminators are 2 terminal devices.

### FEATURES

- Frequency adjustment-free
- Small size, lightweight
- Suitable for Quadrature detection

### DIMENSIONS: mm

MC SERIES	CIRCUIT	ME SERIES	CIRCUIT
<p>① ② ③ : EIA-J Date Code</p>	<p><b>CDA 4.5 MC20</b></p> <p>① INPUT ② GROUND ③ OUTPUT</p>	<p>① ② ③ : EIA-J Date Code</p>	<p><b>CDA 4.5 ME20</b></p> <p>Voltmeter Recovered Audio Signal</p>

### SPECIFICATIONS

#### CDA MC 4.5 ~ 6.5MHz

Part Number	IC	Part Number	IC	Part Number	IC
CDA□MC10	TBA120T	CDA□MC22	M51354AP	CDA□MC30	M51348FP
CDA□MC15	TA7146P	CDA□MC23	M51316P	CDA□MC31	TDA4282T
CDA□MC16	TDA4940	CDA□MC24B	LA7520	CDA□MC32	LA7522
CDA□MC17	TDA4280	CDA□MC25	LA7521	CDA□MC33	μ.PC1416G
CDA□MC18	HA11229	CDA□MC26	LA7530 (N)	CDA□MC34	TBA130-2
CDA□MC19	μ.PC1391H	CDA□MC27	μ.PC1411CA	CDA□MC35	M51345FP
CDA□MC20	μ.PC1382C	CDA□MC28	M51316BP		
CDA□MC21	μ.PC1383C	CDA□MC29	M51365SP		

#### CDA ME 4.5 ~ 6.5MHz

Part Number	IC	Part Number	IC	Part Number	IC
CDA□ME1	CX-20014	CDA□ME8	TBA129	CDA□ME23	M51496P
CDA□ME2	AN5135	CDA□ME10	TDA2546A	CDA□ME27	LA7650
CDA□ME3	TA7678AP	CDA□ME19	M51346BP	CDA□ME30	CXA1110AS
CDA□ME5	AN5135NK	CDA□ME20	LA7550	CDA□ME34	TAB680N
CDA□ME6	M51346AP	CDA□ME21	LA7545	CDA□ME35	LA7680
CDA□ME7	TDA4503	CDA□ME22	TDA2556	CDA□ME37	TAB691N

□ Indicates frequency 4.5, 5.5, 5.74, 6.0, 6.5 MHz are available. Note that part numbers, circuits and ratings vary according to the IC used at detector process.

### PART NUMBERING SYSTEM

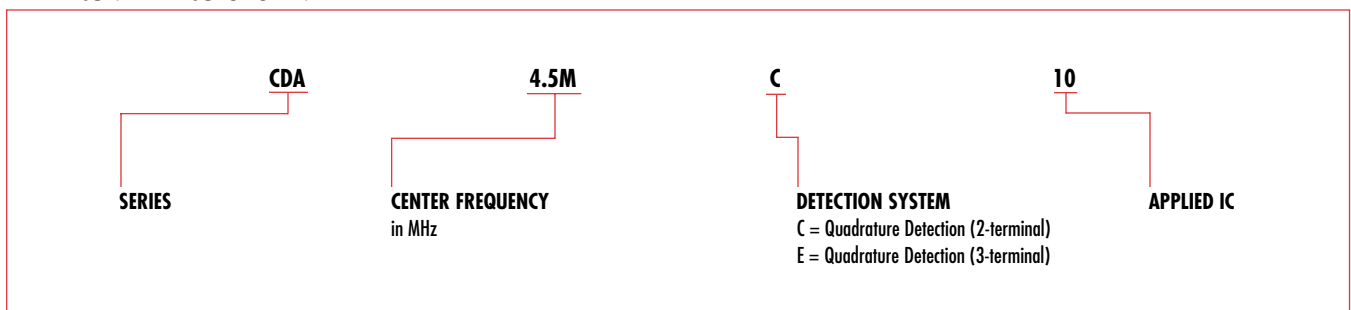

\*Applicable in North American market only. ▼Applicable in European market only.  
 For more detailed information regarding this product line in North America, see Catalog No. P-05-D. To receive additional information on Murata Products call 1-800-831-9172.  
 For more detailed information regarding this product line in Europe, see Catalog No. P25E-2.

FILTERS

# FILTERS

## SAW FILTERS FOR TV/VCR APPLICATIONS COLOR TV VIF/VCR SAF SERIES

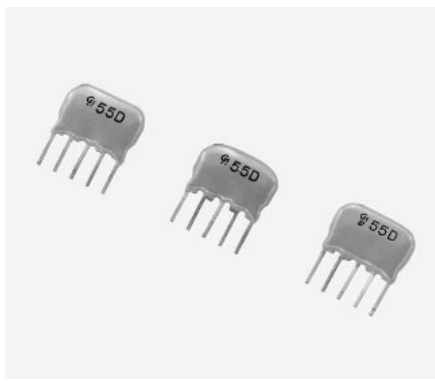

This series of SAW filters is designed for TV/VCR applications. These filters are capable of passing SIF, PIF, SIF or PIF. SAW filters are made up of zinc oxide on a glass substrate. Murata provides SAW filters for a variety of television standards world wide.

### FEATURES

- Frequency adjustment-free.
- High performance. High durability.
- Low cost due to its resin molded structure.
- 80Z and 200Z Series are electromagnetically shielded.

### DIMENSIONS: mm

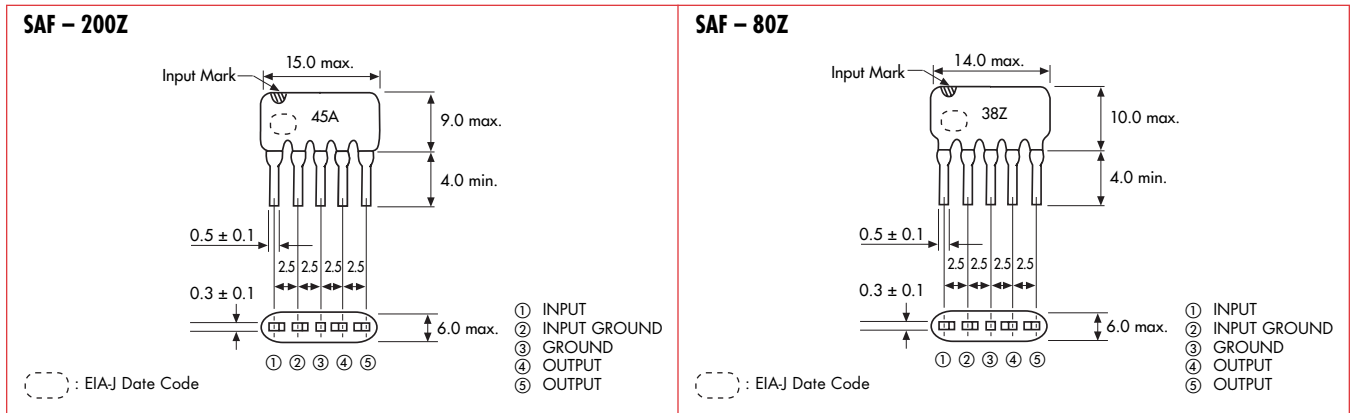

### SPECIFICATIONS

Part Number	Insertion Loss (dB) max.	Picture Carrier (dB)	Chroma Carrier (dB)	Sound Carrier (dB)	Adjacent Sound Carrier (dB) min.	Adjacent Picture Carrier (dB) min.	Spurious Response (dB) min.	Temperature Coefficient (ppm/°C)
SAF58MH210Z	21 (17)	4.2 ± 1.2	4.2 ± 1.5	20 ± 3	40 (57)	40 (53)	30	-28 ± 20
SAF45MA210Z	21 (18)	4.0 ± 1.2	4.5 ± 1.5	18 ± 3	40 (54)	40 (47)	30	-28 ± 20
SAF39.5MZ210Z	25 (22)	5.0 ± 1.2	4.5 ± 1.5	20 ± 3	40 (52)	40 (55)	30	-10 ± 20
SAF38.9MZ210Z	24 (19)	5.0 ± 1.2	5.8 ± 1.5	20 ± 3	40 (55)	40 (47)	30	-10 ± 20
SAF38.0MZ80Z	27 (23)	6.0 ± 1.5	6.6 ± 1.5	25 ± 3	40 (48)	40 (55)	30	-10 ± 20
SAF36.9MZ80Z	25 (21)	5.0 ± 1.2	5.0 ± 1.5	20 ± 3	40 (50)	40 (53)	30	-10 ± 20
SAF32.7MZ80Z	25 (22)	6.5 ± 1.5	1.0 ± 1.0	38 min.	40 (48)	35 (48)	30	-10 ± 20
SAF58MVB200Z	20 (15)	4.5 ± 1.2	4.5 ± 1.5	25 min.	40 (55)	40 (57)	30	-28 ± 20
SAF45MVG200Z	21 (19)	4.5 ± 1.2	4.5 ± 1.5	25 min.	40 (55)	40 (47)	29	-28 ± 20
SAF38.9MVB200Z	24 (21)	4.5 ± 1.2	4.8 ± 1.5	25 min.	40 (48)	40 (55)	30	-10 ± 20

• SAF58MVB200Z, SAF45MVG200Z and SAF38.9MVB200Z are for picture IF filter in Quasi-parallel or Split Carrier System. ( ) Typical value  
 • Low-profile type 6.0mm (60Z) are also available.

### PART NUMBERING SYSTEM

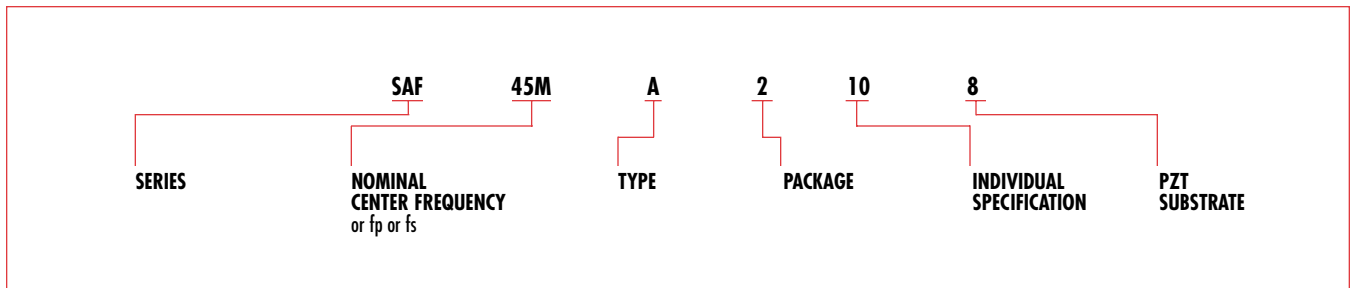

\*Applicable in North American market only. \*Applicable in European market only.  
 For more detailed information regarding this product line in North America, see Catalog No. P-05-D. To receive additional information on Murata Products call 1-800-831-9172.  
 For more detailed information regarding this product line in Europe, see Catalog No. P34E-3.

# FILTERS

## SAW FILTERS FOR TV/VCR APPLICATIONS—AUDIO VISUAL EQUIPMENT SAF SERIES

**Murata**

Innovator in Electronics

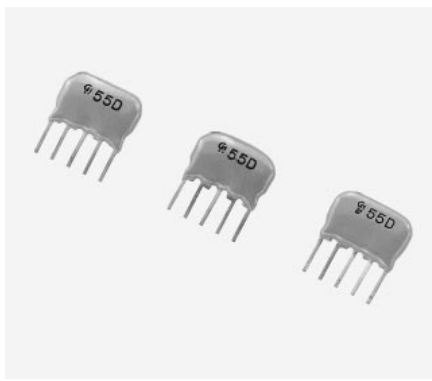

This series of SAW filters is designed for TV/VCR applications. These filters are capable of passing 1) SIF and PIF, 2) SIF or 3) PIF. SAW filters are made up of zinc oxide on a glass substrate. Murata provides SAW filters for a variety of television standards worldwide.

■ 80Z and 200Z Series are electromagnetically shielded.

### FEATURES

- Frequency adjustment-free
- High performance. High durability.
- Low cost due to its resin molded structure.

### DIMENSIONS: mm

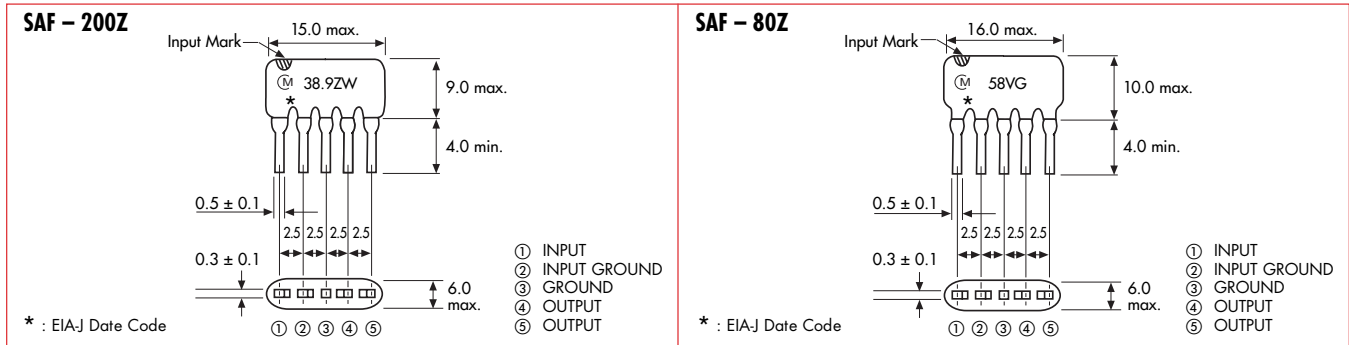

### SPECIFICATIONS FOR NEW-FTZ

Part Number	Insertion Loss (dB) max.	Picture Carrier (dB)	Chroma Carrier (dB)	Sound Carrier (dB)	Adjacent Sound Carrier (dB) min.	Attenuation at $f_{as} + 1.0\text{MHz}$ (dB) min.	Attenuation at $f_{ap} - 0.5\text{MHz}$ (dB) min.	Adjacent Picture Carrier (dB) min.	Attenuation at $f_{ap} + 0.5\text{MHz}$ (dB) min.	Spurious Response (dB) min.	Temperature Coefficient (ppm/°C)
SAF38.9MZ80Z	25.5 (19)	$4.7 \pm 1.2$	$5.2 \pm 1.5$	$19.0 \pm 3$	40 (50)	—	33 (48)	40 (48)	35 (48)	30	$-10 \pm 20$
SAF38.9MZR80Z	24.0 (22)	$4.5 \pm 1.2$	$4.5 \pm 1.5$	$22.0 \pm 3$	40 (48)	38 (48)	35 (45)	40 (48)	37 (50)	30	$-10 \pm 20$
SAF38.9MW210Z	22.5 (20)	$4.5 \pm 1.2$	$3.1 \pm 1.0$	$17.5 \pm 3$	43 (54)	38 (52)	38 (42)	36 (42)	38 (42)	33	$-10 \pm 20$

### FOR HIGH PICTURE LEVEL (WIDE PASS BAND)

Part Number	Insertion Loss (dB) max.	Picture Carrier (dB)	Chroma Carrier (dB) max.	Sound Carrier (dB) min.	Attenuation at $f_p - 4.0\text{MHz}$ (dB) max.	Adjacent Sound Carrier (dB) min.	Adjacent Picture Carrier (dB) min.	Spurious Response (dB) min.	Temperature Coefficient (ppm/°C)
SAF58MVG80Z	23 (20)	$4.8 \pm 1.2$	1.0	20	5.0 (2.0)	40 (53)	40 (58)	30	$-28 \pm 20$
SAF45MVE80Z	23 (20)	$5.0 \pm 1.2$	1.2	20	5.5 (2.7)	40 (48)	40 (53)	28	$-28 \pm 20$

### DUAL TYPE (FOR PICTURE AND SOUND)

Part Number	Insertion Loss (dB) max.	Picture Carrier (dB)	Attenuation (dB) max. at $f_c - 0.5\text{MHz}$	Chroma Carrier (dB)	Attenuation (dB) max. at $f_s - 0.2\text{MHz}$	Sound Carrier (dB)	Attenuation (dB) max. at $f_s + 0.2\text{MHz}$	Adjacent Sound Carrier (dB) min.	Adjacent Picture Carrier (dB) min.	Spurious Response (dB) min.	Spurious Response (dB) min.	Temperature Coefficient (ppm/°C)
SAFW58MCB80Z Picture Channel	22	$4.9 \pm 1.2$	11	1.2 max.	—	24 min.	—	40	40	33 (0 ~ 52.75MHz)	33 (60.25 ~ 70MHz)	$-28 \pm 20$
Sound Channel	29	20 min.	—	16 min.	4	0	4	22	24	22 (0 ~ 52.75MHz)	33 (60.25 ~ 70MHz)	$-28 \pm 20$
SAFW45MCC80Z Picture Channel	24	$4.7 \pm 1.2$	6	1.2 max.	—	24 min.	—	43	43	30 (0 ~ 39.75MHz)	30 (47.25 ~ 54MHz)	$-28 \pm 20$
Sound Channel	29	20 min.	—	16 min.	4	0	4	20	22	22 (0 ~ 39.75MHz)	15 (47.25 ~ 54MHz)	$-28 \pm 20$

Note 1: Since insertion loss of Surface Acoustic Wave Filters varies with matching state, values on this table do not always meet the values measured at actual circuit.

Note 2:  $f_p$  - Picture Carrier,  $f_c$  - Chroma Carrier,  $f_{as}$  - Adjacent Sound Carrier,  $f_{ap}$  - Adjacent Picture Carrier.

### PART NUMBERING SYSTEM

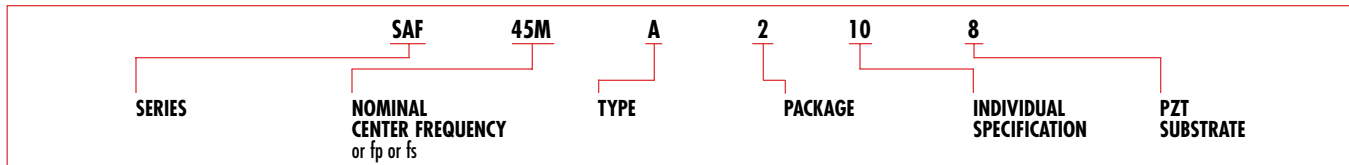

\*Applicable in North American market only. \*Applicable in European market only.

For more detailed information regarding this product line in North America, see Catalog No. P-05-D. To receive additional information on Murata Products call 1-800-831-9172.

For more detailed information regarding this product line in Europe, see Catalog No. P34E-3.

FILTERS

# FILTERS

## SAW FILTERS FOR TV/VCR APPLICATIONS—MULTI TV/VCR/VIF SAF SERIES

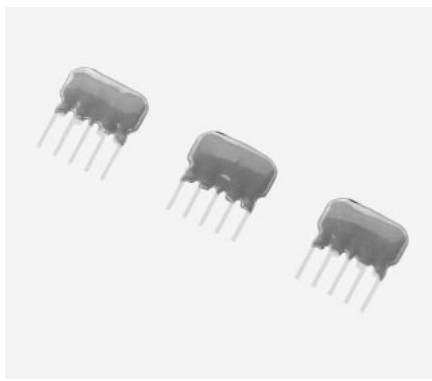

This series of SAW filters is designed for TV/VCR applications. These filters are capable of passing 1) SIF and PIF, 2) SIF or 3) PIF. SAW filters are made up of zinc oxide on a glass substrate. Murata provides SAW filters for a variety of television standards worldwide.

- 80Z and 200Z Series are electromagnetically shielded.

### FEATURES

- Frequency adjustment-free.
- High performance. High durability.
- Low cost due to its resin molded structure.

### DIMENSIONS: mm

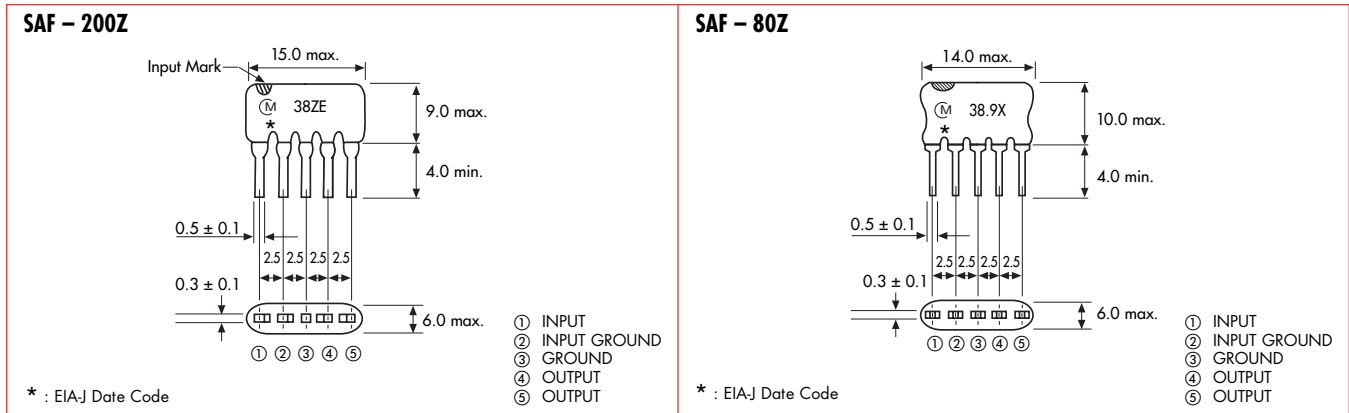

### SPECIFICATIONS FOR MULTI SYSTEM TV/VCR

Part Number	Insertion Loss (dB) max.	Picture Carrier (dB)	Chroma Carrier (dB)	Sound 1 Carrier (dB)	Sound 2 Carrier (dB)	Sound 3 Carrier (dB)	Adjacent Sound Carrier (dB) min.	Adjacent Picture Carrier (dB) min.	Spurious Response (dB) min.	Temperature Coefficient (ppm/°C)	System
SAF38.0MZE210Z	27 (22)	4.8 ± 1.2	3.8 ± 1.3	17.5 ± 3.0	—	17.0 ± 3.0	40 (53)	40 (53)	30 (43)	-10 ± 20	D/K/B/G/I
SAF38.0MZJ80Z	29 (26)	5.1 ± 1.2	4.1 ± 1.5	22.0 ± 3.0	—	19.5 ± 3.0	40 (56)	40 (55)	30 (40)	-10 ± 20	D/K/B/G/I
SAF38.9MX80Z	26 (23)	5.0 ± 1.2	3.7 ± 1.0	18.0 ± 3.0	—	22.0 ± 3.0	40 (58)	35 (52)	30 (40)	-10 ± 20	B/G/I/D/K
SAF38.9MZA80Z	25 (22)	4.5 ± 1.3	4.5 ± 1.3	16.5 ± 3.0	15.0 ± 3.0	20.0 ± 3.0	45 (53)	40 (58)	30 (40)	-10 ± 20	B/G/I/D/K
SAF38.9MZC200Z	25.5 (22)	3.7 ± 1.3	4.3 ± 1.3	15.5 ± 3.0	—	16.5 ± 3.0	40 (50)	40 (47)	30 (36)	-10 ± 20	B/G/I/D/K

( ) Typical value

### PART NUMBERING SYSTEM

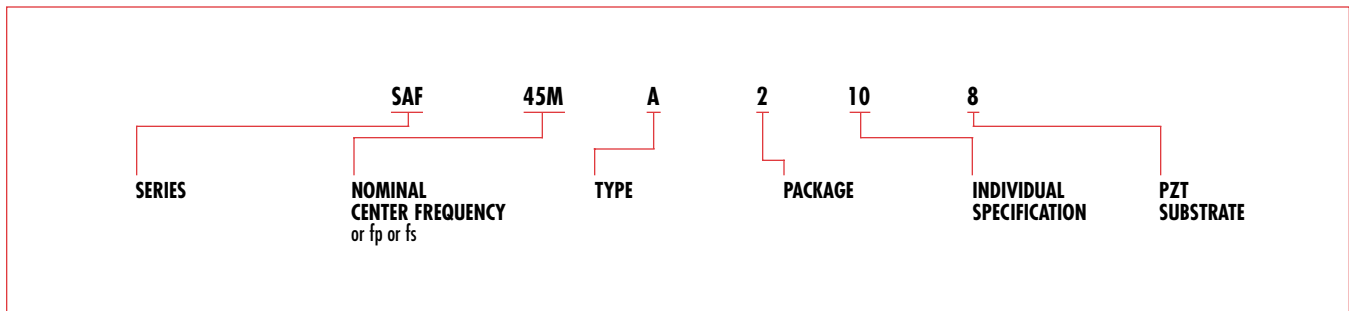

\*Applicable in North American market only. ▼Applicable in European market only.  
For more detailed information regarding this product line in North America, see Catalog No. P-05-D. To receive additional information on Murata Products call 1-800-831-9172.  
For more detailed information regarding this product line in Europe, see Catalog No. P34E-3.

# FILTERS

## SAW FILTERS FOR TV/VCR APPLICATIONS

### SAF SERIES

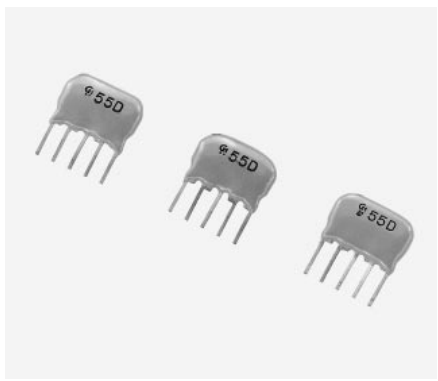

This series of SAW filters is designed for TV/VCR applications. These filters are capable of passing 1) SIF and PIF, 2) SIF or 3) PIF. SAW filters are made up of zinc oxide on a glass substrate. Murata provides SAW filters for a variety of television standards worldwide.

■ 200Z Series are electromagnetically shielded.

#### FEATURES

- Frequency adjustment-free
- High performance. High durability.
- Low cost due to its resin molded structure.

#### DIMENSIONS: mm

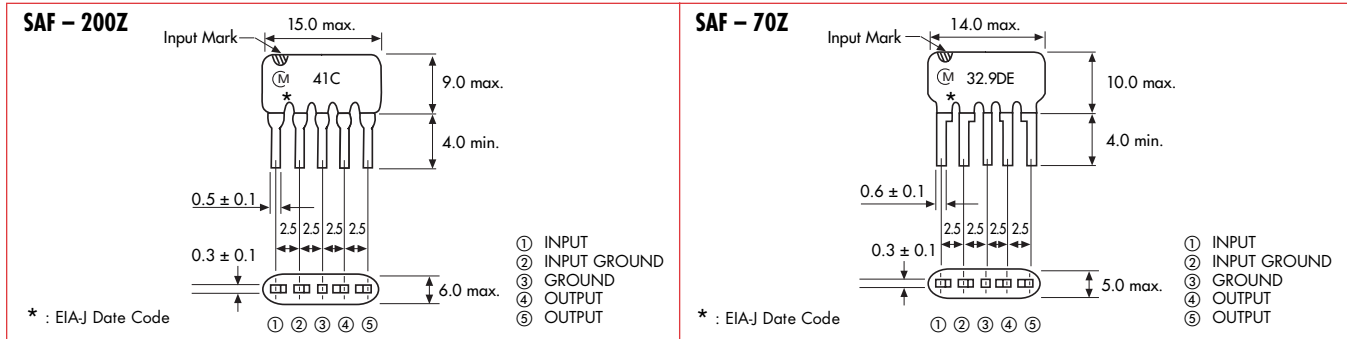

#### SPECIFICATIONS FOR TV/VCR SOUND IF

Part Number	Insertion Loss (dB) max.	Picture Carrier (dB)	Chroma Carrier (dB) min.	Attenuation (dB) max. at fs-0.3MHz	Attenuation (dB) max. at fs+0.3MHz	Adjacent Sound Carrier (dB) min.	Adjacent Picture Carrier (dB) min.	Spurious Response (dB) min.	Spurious Response (dB) min.	Temperature Coefficient (ppm/°C)
SAF54MC200Z	16 (13)	40 min.	17	3	3	40	37	28 (0 ~ 52.75MHz)	30 (56.75 ~ 70MHz)	-28 ± 20
SAF41MC200Z	17 (14)	40 min.	17	3	3	40	37	28 (0 ~ 39.75MHz)	30 (43.75 ~ 56MHz)	-28 ± 20
SAF39.2MC70Z	19 (14)	40 min.	35	6	6	40	30	30 (28 ~ 31.2MHz)	30 (40.7 ~ 45MHz)	-10 ± 20
SAF33.4MC200Z	20 (18)	40 min.	20	4	4	40	35	30 (0 ~ 31.9MHz)	30 (40.4 ~ 47MHz)	-10 ± 20
SAF54MD70Z	20 (11)	within ±30	20	fs - 0.2MHz 3	fs - 0.2MHz 3	35	35	30 (0 ~ 70MHz)	15 <sup>1</sup> (55.5 ~ 57.5MHz)	-28 ± 20
SAF41MD70Z	17 (14)	within ±30	20	fs - 0.2MHz 3	fs - 0.2MHz 3	35	35	30 (0 ~ 55MHz)	15 <sup>1</sup> (42.5 ~ 44.5MHz)	-28 ± 20
SAF33.4MD70Z	20 (16)	within ±30	20	fs - 0.2MHz 3	fs - 0.2MHz 3	35	35	30 (0 ~ 50MHz)	15 <sup>1</sup> (34.67 ~ 37.7MHz)	-10 ± 20
SAF33.0MDA70Z	26 (23)	5.0 ± 3.0	12	fs - 0.2MHz 3	fs - 0.2MHz 3	26	20	15 (0 ~ 39.5MHz)	8 <sup>1</sup> (34.67 ~ 37.MHz)	-10 ± 20
SAF32.9MDE70Z	25 (23)	4.3 ± 3.0	15	fs - 0.2MHz 3	fs - 0.2MHz 3	35	25	28 (0 ~ 31.5MHz)	10 <sup>1</sup> (35.27 ~ 38MHz)	-10 ± 20
SAF31.4MD70Z	28 (26)	within ±3	15	fs - 0.2MHz 3	fs+0.2MHz 3	35	35	30 (0 ~ 45MHz)	15 <sup>1</sup> (32.645 ~ 36.675MHz)	-10 ± 20

• SAF54MC70Z, SAF41MC200Z and SAF33.4MC200Z are for Split Carrier System.  
 • SAF54MD70Z, SAF41MD70Z, SAF33.4MD70Z and SAF31.4MD70Z are for Quasi-Parallel System.

• SAF33.0MDA70Z is for Multi-Sound TV in Northern Europe.  
 • SAF32.9MDE70Z is for Multi-Sound TV in U.K.  
 • 0dB level should be at fs.

( ) Typical value  
<sup>1</sup>Minimum attenuation between picture carrier and sound carrier

#### PART NUMBERING SYSTEM

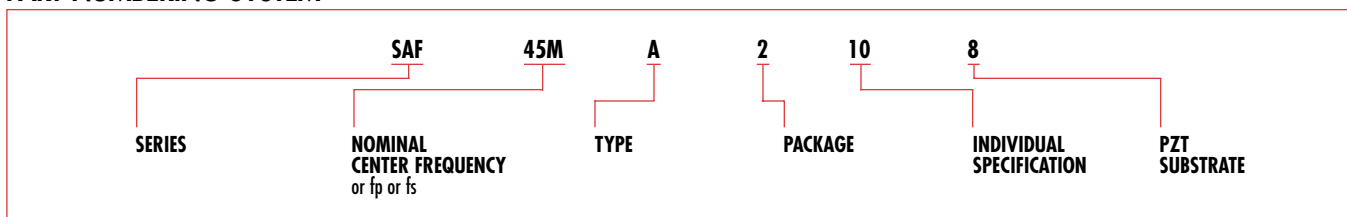

\*Applicable in North American market only. †Applicable in European market only.

For more detailed information regarding this product line in North America, see Catalog No. P-05-D. To receive additional information on Murata Products call 1-800-831-9172.  
 For more detailed information regarding this product line in Europe, see Catalog No. P34E-3.



# FILTERS

## SAW FILTERS FOR TV/VCR APPLICATION FOR SET TOP BOX (CATV) SAF SERIES

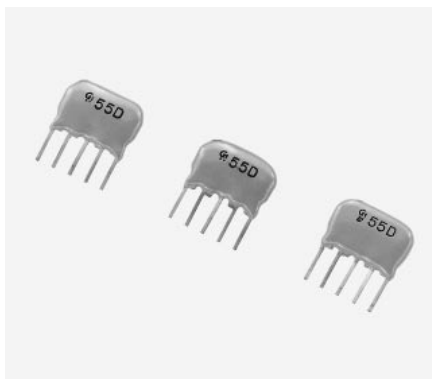

This series of SAW filters is designed for TV/VCR applications. These filters are capable of passing 1) SIF and PIF, 2) SIF or 3) PIF. SAW filters are made up of zinc oxide on a glass substrate. Murata provides SAW filters for a variety of television standards worldwide.

### FEATURES

- Adjustment-free
- Associated parts can be reduced.
- Vary stable phase characteristics
- Low cost due to its resin molded structure.

### DIMENSIONS: mm

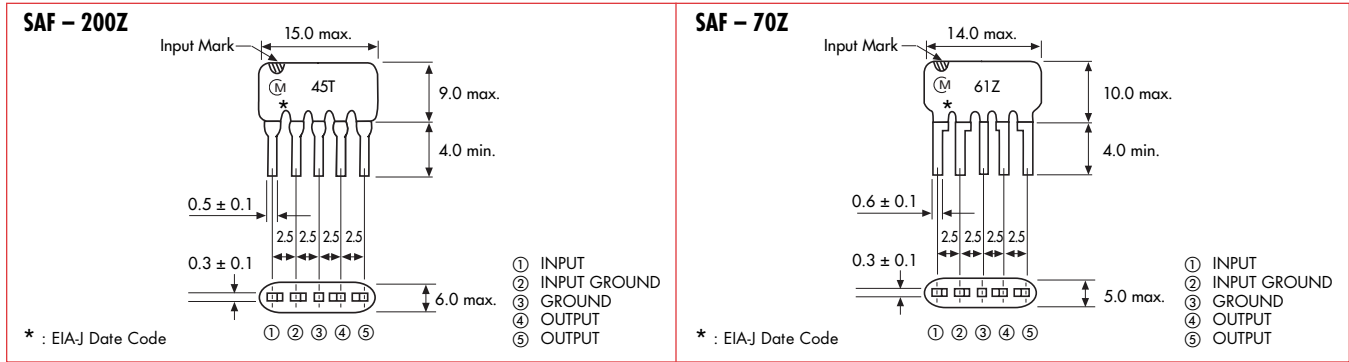

### SPECIFICATIONS

Part Number	Insertion Loss (dB) max.	Flatness (dB) max.	Lower ch. Picture Carrier (dB) min.	Lower ch. Sound Carrier (dB) min.	Picture Carrier (dB)	Chroma Carrier (dB)	Sound Carrier (dB)	Upper ch. Picture Carrier (dB) min.	Spurious Response (dB) min.	Temperature Coefficient (ppm/°C)
SAF45MT210Z	23	2 <sup>10</sup>	14	—	2 max.	2 max.	2 max.	30	27	-28 ± 20
SAF55MB70Z	21	2	35	8	0	0 ± 1	2 max.	35	26	-28 ± 20
SAF61MB70Z	20	1 <sup>2</sup>	35	8	0	0 ± 1	2 max.	35	26 <sup>6</sup>	-28 ± 20
SAF61MD70Z	23	2 <sup>3</sup>	30 <sup>4</sup>	8 <sup>4</sup>	2 max <sup>4</sup>	2 max.	2 max.	14 <sup>4</sup>	14 <sup>8</sup>	-28 ± 20
SAF61MZ72Z	22	—	30 <sup>4</sup>	40 <sup>4</sup>	5.5 ± 1.2 <sup>4</sup>	5.0 ± 1.5 <sup>4</sup>	20 ± 3 <sup>4</sup>	40 <sup>4</sup>	28.30 <sup>8</sup>	-28 ± 20
SAF67MB70Z	20	2	35	8	0	0 ± 1	2 max.	35	26	-28 ± 20

• SAF61MD70Z is a wide-band type. SAF61MZ72Z is for direct detection systems. \*Reference Point. <sup>2</sup>61.25 – 64.83MHz. <sup>3</sup>61.25 – 65.75MHz. <sup>4</sup>Reference level (0dB) is the peak value. <sup>5</sup>50–55.25MHz 67.25–78MHz <sup>6</sup>0–55.25MHz 67.25–80MHz <sup>7</sup>0–55.25MHz 68.25–80MHz <sup>8</sup>30: 0–59.75MHz 28: 67.25–80MHz <sup>10</sup>41.25–45.75MHz  
 Note: SAF55MB70Z is full channel pass filter for channel 2. SAF61MB70Z is full channel pass filter for channel 3. SAF67MB70Z is full channel pass filter for channel 4. For channel 2 SAF59.8MA72Z, channel 3 SAF65.8MA72Z and channel 4 SAF71.8MA72Z is the Sound Intermediate Frequency (SIF).

### PART NUMBERING SYSTEM

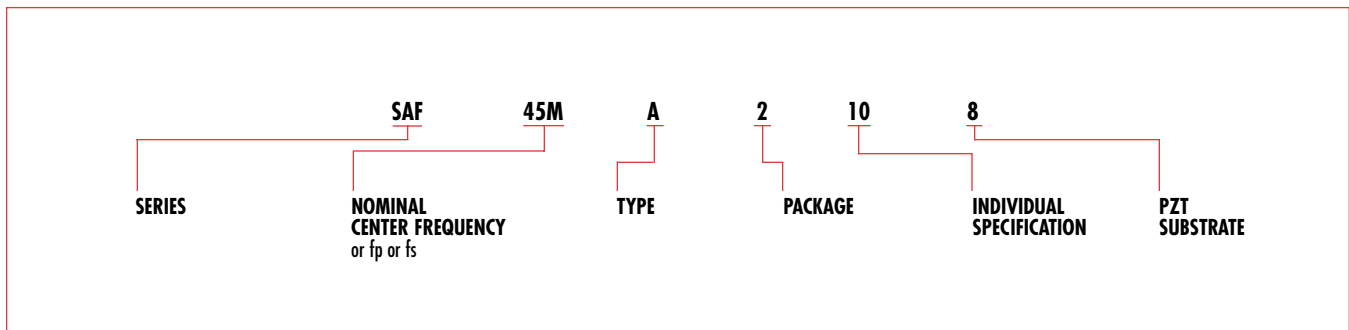

\*Applicable in North American market only. †Applicable in European market only.  
 For more detailed information regarding this product line in North America, see Catalog No. P-05-D. To receive additional information on Murata Products call 1-800-831-9172.  
 For more detailed information regarding this product line in Europe, see Catalog No. P34E-9.

# FILTERS

## SAW FILTERS FOR TV/VCR APPLICATIONS

### SAF SERIES

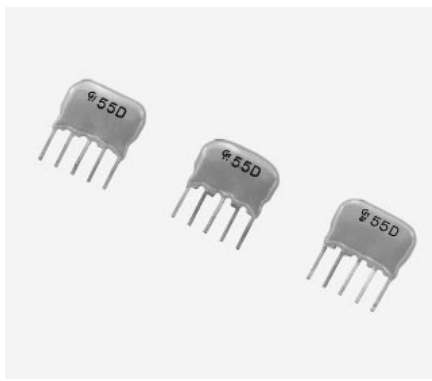

This series of SAW filters is designed for TV/VCR applications. These filters are capable of passing 1) SIF and PIF, 2) SIF or 3) PIF. SAW filters are made up of zinc oxide on a glass substrate. Murata provides SAW filters for a variety of television standards worldwide.

- 200Z Series are electromagnetically shielded.

#### FEATURES

- Frequency adjustment-free
- High performance. High durability.
- Low cost due to its resin molded structure.

#### DIMENSIONS: mm

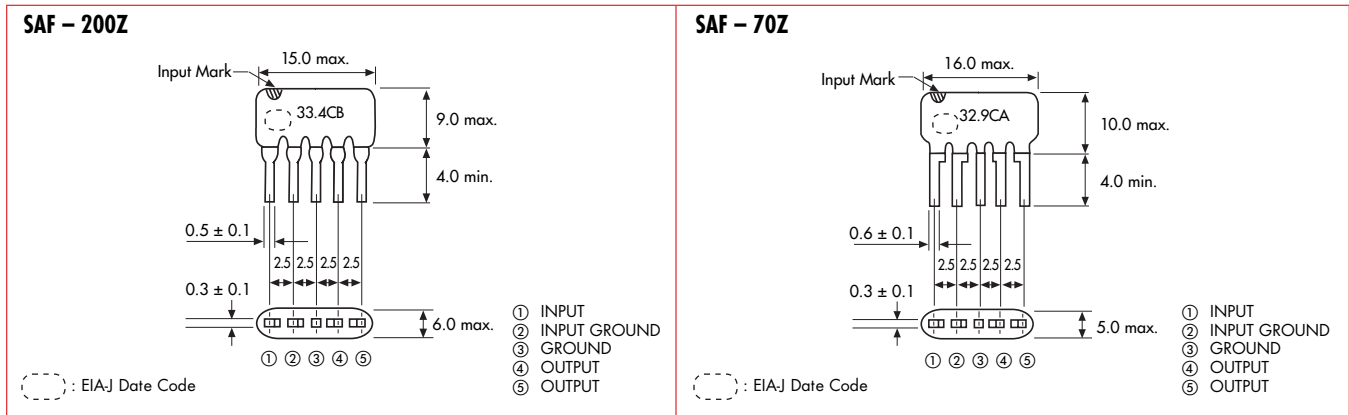

#### SPECIFICATIONS

Part Number	Insertion Loss (dB) max.	Picture Carrier (dB) max.	Chroma Carrier (dB) min.	Attenuation (dB) max. at fs-0.3MHz	Sound 1 (fs1) Carrier (dB) max.	Sound 2 (fs2) Carrier (dB) max.	Attenuation (dB) max. at fs+0.3MHz	Adjacent Sound Carrier (dB) min.	Adjacent Picture Carrier (dB) min.	Spurious Response (dB) min.	Spurious Response (dB) min.	Temperature Coefficient (ppm/°C)
SAF32.0MCA70Z	26 (23)	35 (55)	25 (35)	6	3	3	6	40 (55)	35 (50)	30 (35) (0 ~ 30MHz)	22 (35) (33.57 ~ 42MHz)	-10 ± 20
SAF32.9MCA70Z	25 (22)	35 (53)	25 (34)	6	3	3	6	40 (55)	35 (43)	30 (39) (0 ~ 30.9MHz)	22 (35) (34.47 ~ 42MHz)	-10 ± 20
SAF33.4MCB200Z	29 (26)	30 (47)	14 (30)	6	3	3	6	30 (46)	35 (50)	25 (33) (0 ~ 30.9MHz)	25 (39) (40.4 ~ 46.0MHz)	-10 ± 20

- Since the insertion loss of surface acoustic wave filters varies with the matching state, the values of insertion loss in the table are not always in conformity with insertion loss of the actual circuit. ( ) Typical value
- fp-picture carrier, fc-chroma carrier, fs-sound carrier, fas-adjacent sound carrier, fap-adjacent picture carrier.

#### PART NUMBERING SYSTEM

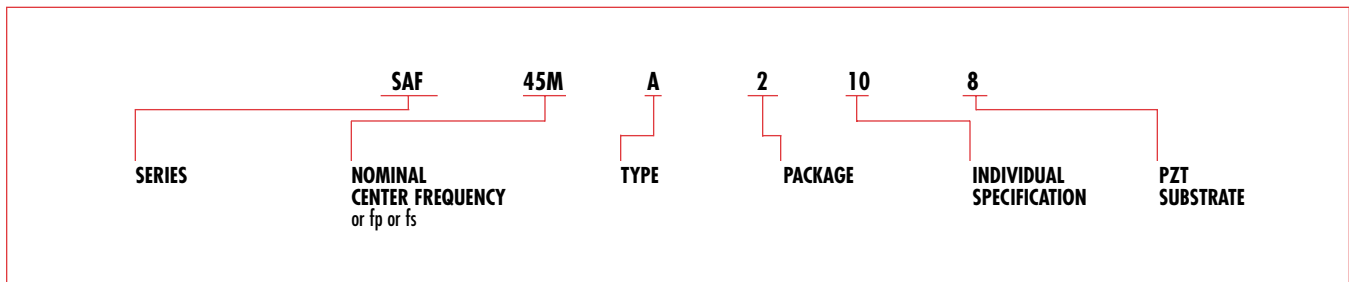

▲Applicable in North American market only. ▼Applicable in European market only.  
 For more detailed information regarding this product line in North America, see Catalog No. P-05-D. To receive additional information on Murata Products call 1-800-831-9172.  
 For more detailed information regarding this product line in Europe, see Catalog No. P34E-3.

# FILTERS

## SAW FILTERS FOR TV/VCR APPLICATIONS—AUDIO VISUAL EQUIPMENT MKT SERIES

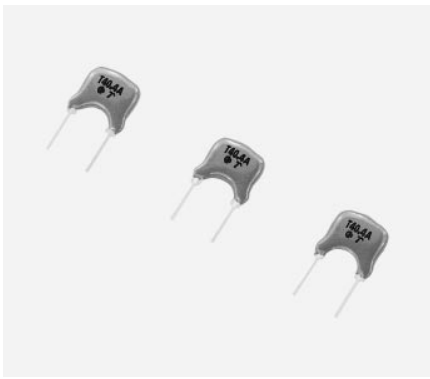

High frequency trap MKT Series is a high performance trap which is designed with surface acoustic wave on piezo ceramics. It has achieved small package and high reliability based on MURATA original resin mold technology.

- Suitable for meeting FTZ and CENELEC spec
- Taped type are also available.

### FEATURES

- Frequency adjustment-free
- High performance, high reliability with excellent temperature characteristics

### DIMENSIONS: mm

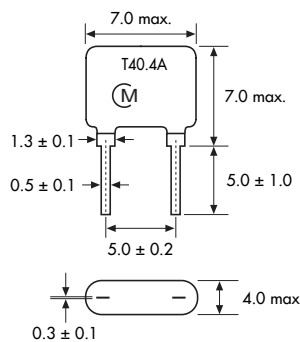

### CIRCUIT

**MKT40.4MA110P**

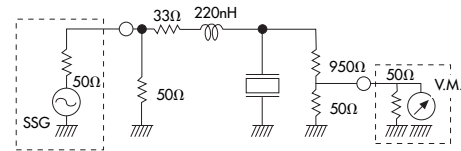

- Attenuation MKT40.4MA110P: 38.9MHz point, MKT31.9MA110P: 33.4MHz point.
- 30.9MHz, 39.5MHz, 47.25MHz and 60.25 MHz types are also available.

### SPECIFICATIONS

### MKT MA SERIES

Part Number	Nominal Center Frequency (MHz)	10dB Band Width (kHz) min.	Ripple (dB) max.	*Attenuation (dB) max.
MKT47.3MA110P	47.25	65	1.0	2.0
MKT40.4MA110P	40.4			
MKT31.9MA110P	31.9			

\*Attenuation at fp

### PART NUMBERING SYSTEM

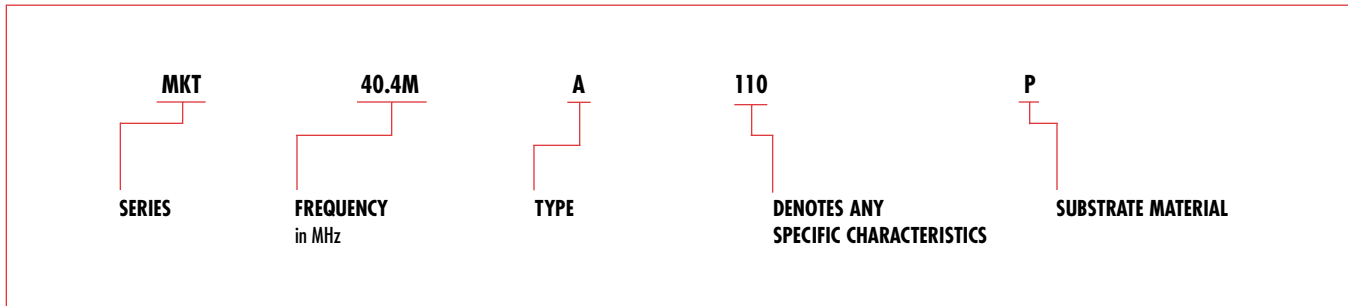

▲Applicable in North American market only. ▼Applicable in European market only.  
For more detailed information regarding this product line in North America, see Catalog No. P-05-D. To receive additional information on Murata Products call 1-800-831-9172.  
For more detailed information regarding this product line in Europe, see Catalog No. P34E-3.

# FILTERS

## FOR TV/VCR APPLICATIONS FOR SET TOP BOX (CATV) SAF SERIES

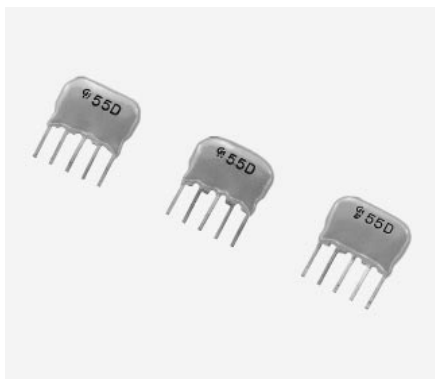

This series of SAW filters is designed for TV/VCR applications. These filters are capable of passing 1) SIF and PIF, 2) SIF or 3) PIF. SAW filters are made up of zinc oxide on a glass substrate. Murata provides SAW filters for a variety of television standards worldwide.

### FEATURES

- Adjustment-free
- Associated parts can be reduced.
- Vary stable phase characteristics
- Low cost due to its resin molded structure

### DIMENSIONS: mm

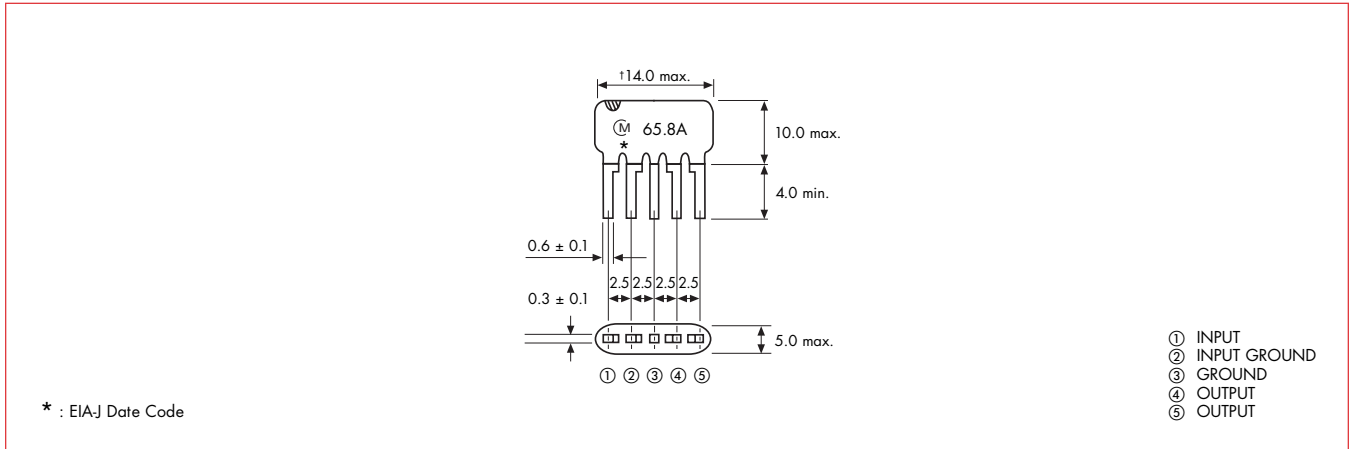

†SAF41MCA70Z = 16.0 max.

### SPECIFICATIONS

Part Number	Insertion Loss (dB max.)	Picture Carrier (dB)	Attenuation (dB) at $f_s - 0.25\text{MHz}$	Attenuation (dB) at $f_s + 0.25\text{MHz}$	Upper ch. Picture Carrier (dB)	Spurious Response (dB) min.	Temperature Coefficient (ppm/°C)
SAF65.8MA72Z	18	(25)	3	3	(30)	20*	$-28 \pm 20$
SAF41MCA70Z	17	(40)	$(f_s - 0.2\text{MHz})$ 3.5	$(f_s + 0.2\text{MHz})$ 3.5	(37)	30	$-28 \pm 20$

\* The level at sound carrier frequency ( $f_s$ ) is to be the reference (0dB). \*0-64.7 MHz, 66.8-100MHz.  
 Note: Consult us for 36.15MHz or other characteristics.

### PART NUMBERING SYSTEM

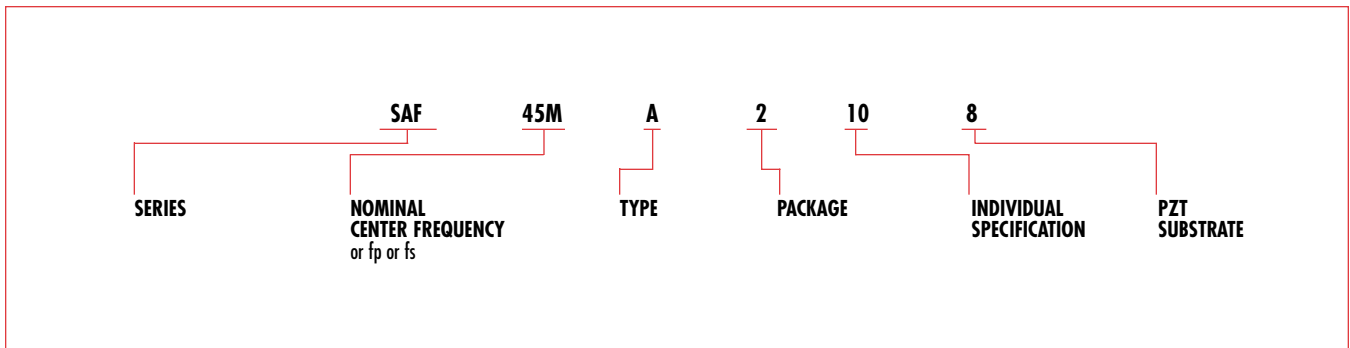

▲Applicable in North American market only. ▼Applicable in European market only.  
 For more detailed information regarding this product line in North America, see Catalog No. P-05-D. To receive additional information on Murata Products call 1-800-831-9172.  
 For more detailed information regarding this product line in Europe, see Catalog No. P34E-3.