

SAW FILTER FOR GPS

Murata part number :SAFEB1G57KD0F00

■ Package Dimensions

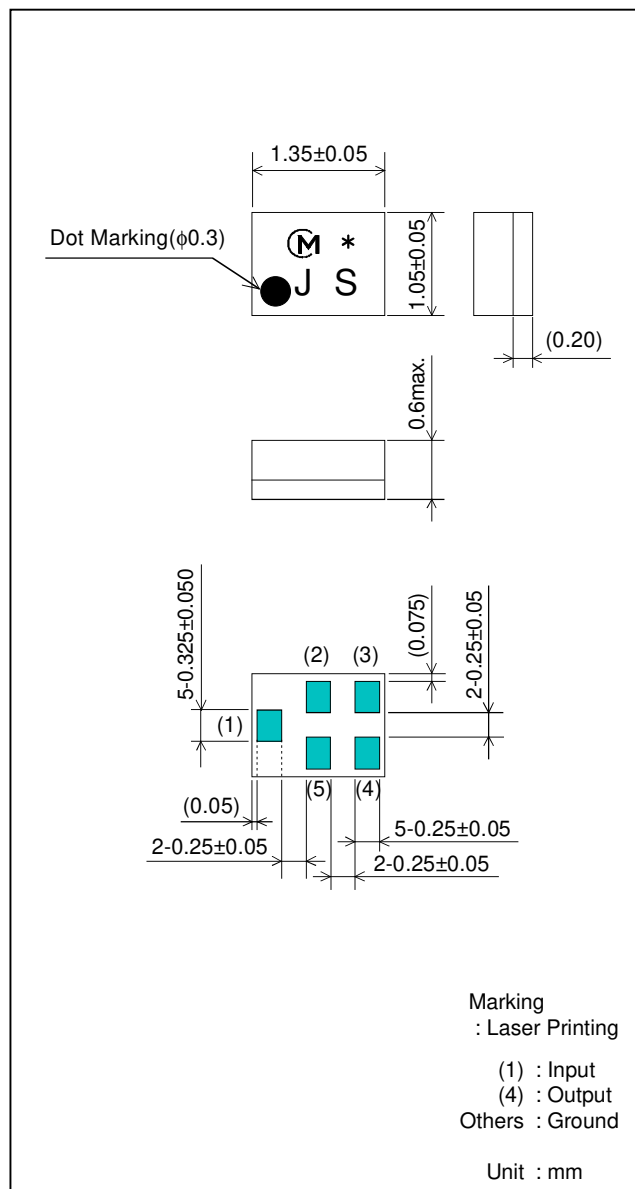

■ Specification

Item	Specification		
	-30 to 85°C	25±2°C	typ.
Nominal Center Frequency (fc)	1575.42MHz		
Insertion Loss (1574.22 to 1576.62MHz)	1.2 dB max.	1.1 dB max.	0.84 dB
Absolute Attenuation			
1) 0.1 to 824 MHz	32 dB min.	32 dB min.	35 dB
2) 824 to 849 MHz	32 dB min.	32 dB min.	35 dB
3) 849 to 960 MHz	32 dB min.	32 dB min.	35 dB
4) 1495 to 1515 MHz	35 dB min.	35 dB min.	43 dB
5) 1635 to 1655 MHz	40 dB min.	40 dB min.	45 dB
6) 1710 to 1750 MHz	35 dB min.	35 dB min.	44 dB
7) 1750 to 1780 MHz	40 dB min.	40 dB min.	44 dB
8) 1780 to 1785 MHz	40 dB min.	40 dB min.	44 dB
9) 1850 to 1910 MHz	40 dB min.	40 dB min.	46 dB
10) 1920 to 1980 MHz	40 dB min.	40 dB min.	48 dB
11) 2402 to 2480 MHz	40 dB min.	40 dB min.	47 dB
12) 3000 to 4000 MHz	28 dB min.	28 dB min.	35 dB
13) 4000 to 6000 MHz	28 dB min.	28 dB min.	32 dB
Ripple Deviation (1575.4 to 1577.4MHz)	0.5dB max.	0.4dB max.	0.06 dB
VSWR (1575.4 to 1577.4MHz)	1.7 max.	1.6 max.	1.3
Input/Output Impedance (nominal)	50Ω		
Input Signal Level	50mW (+17dBm), 2000 hours		

SAW FILTER FOR GPS

Murata part number :SAFEB1G57KD0F00

■ Frequency Performance

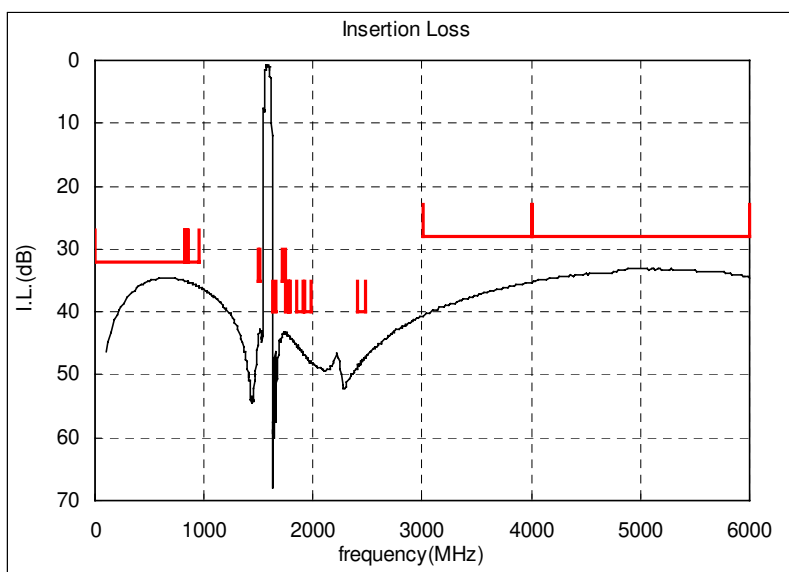
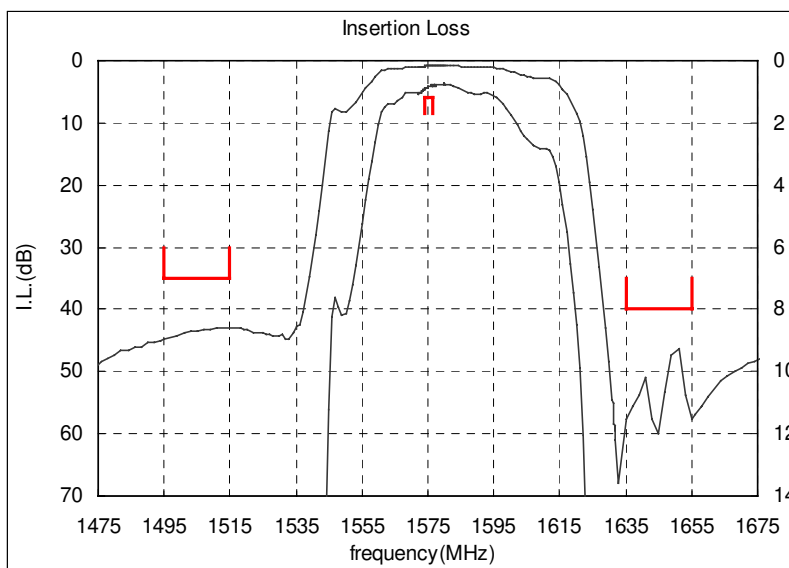

SAW FILTER FOR GPS

Murata part number :SAFEB1G57KD0F00

■ Dimensions of Carrier Tape

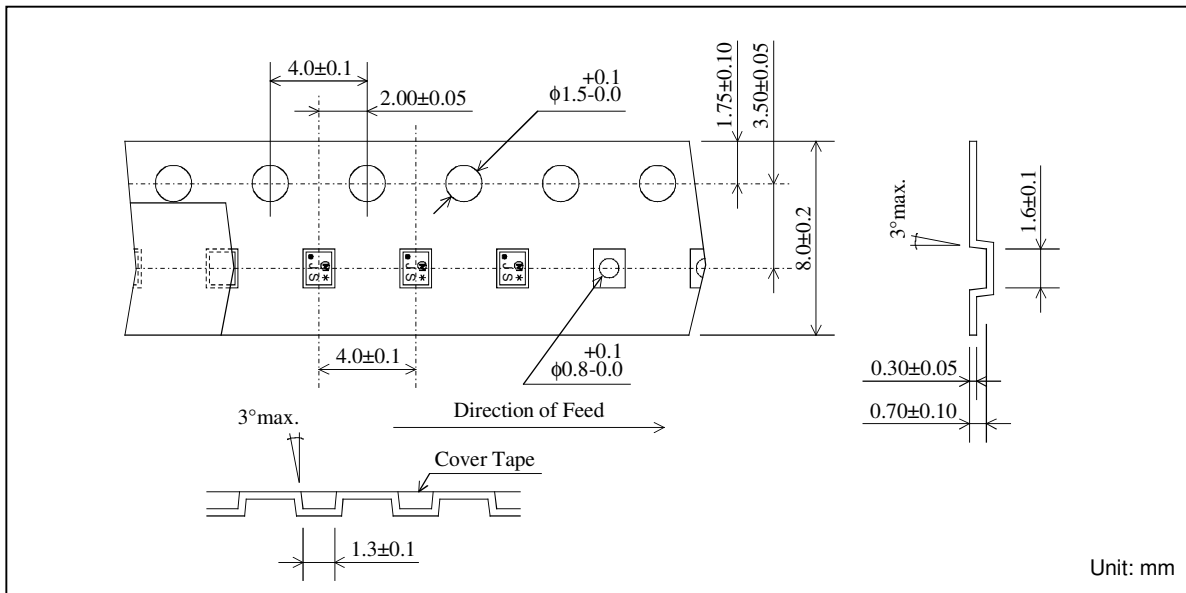

■ Dimensions of Tape

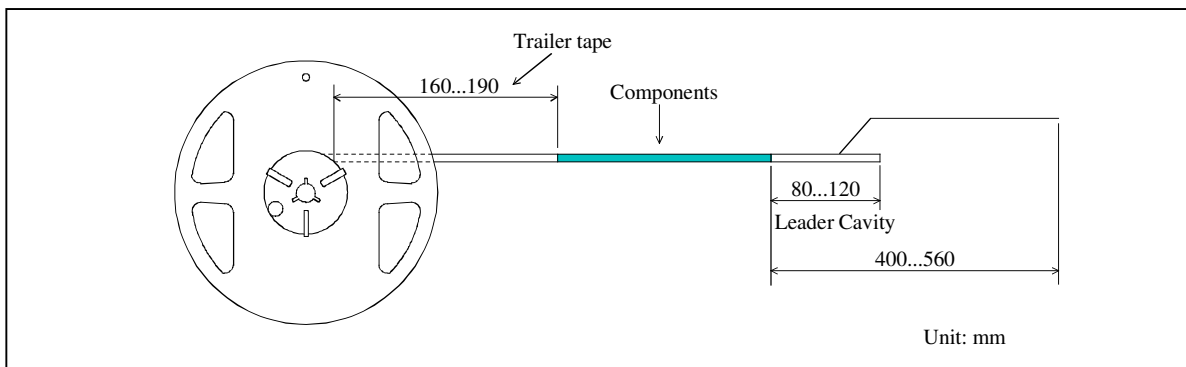

■ Dimensions of Reel

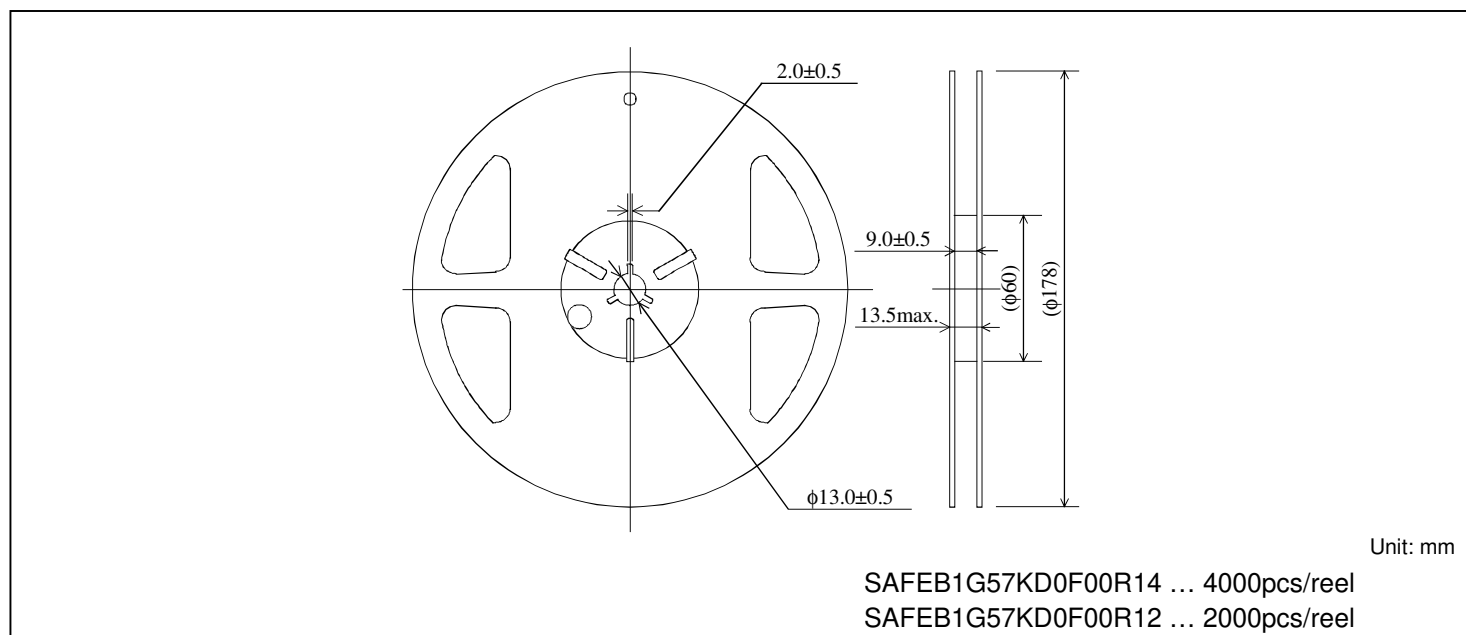

SAW FILTER FOR GPS

Murata part number :SAFEB1G57KD0F00

■ Recommended Land Pattern

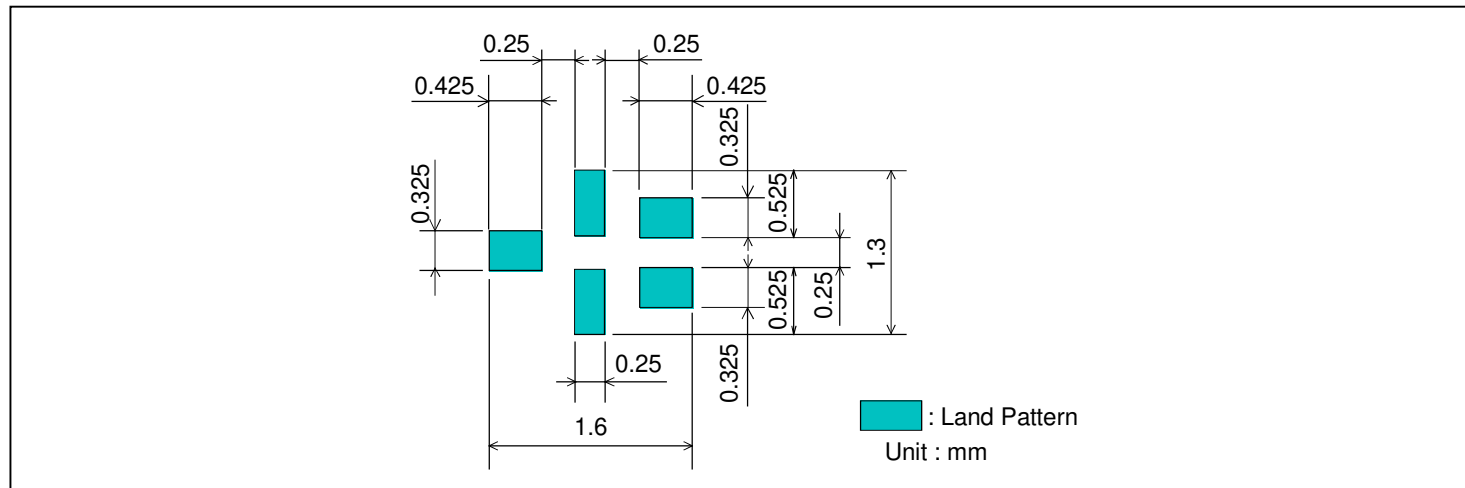

■ Test Circuit

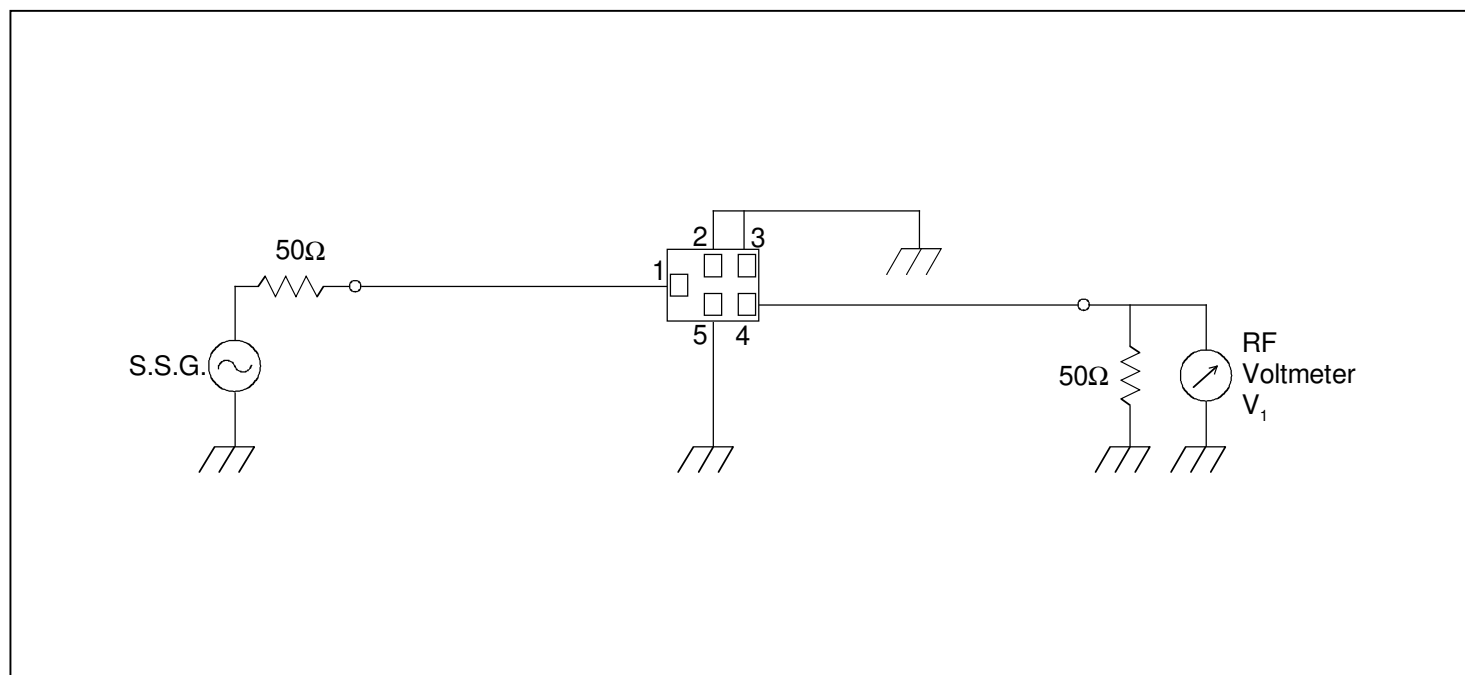

- This PDF Datasheet is downloaded from the website of Murata Manufacturing Co., Ltd. Therefore, it's specifications are subject to change or our products in it may be discontinued without advance notice. Please check with our sales representatives or product engineers before ordering.
- This PDF Datasheet has only typical specifications because there is no space for detailed specifications. Therefore, please approve our product specifications or transact the approval sheet for product specifications before ordering.