

アキシャルリードインダクタ

AXIAL LEADED INDUCTORS

OPERATING TEMP	-25~+105°C (製品自己発熱を含む) (Including self-generated heat)
----------------	---



特長 FEATURES

- ・自動挿入に対し極めて高い信頼性を有するインダクタ
- ・自動化高速ラインによる生産の為、量産性に優れかつ高品質
- ・アキシャルリードタイプその他、ラジアルテーピング、単品加工品がありバリエーションが豊富
- ・Extremely reliable inductors that are ideal for automatic insertion.
- ・Highly efficient automated production processes can provide high quality inductors in large volumes.
- ・Wide selection of configurations including axial leaded, formed radial leads and bulk products to meet most manufacturing needs.

用途 APPLICATIONS

- ・VTR、CTV、オーディオ、通信機、その他電子機器全般
- Consumer electronics such as VCRs, TVs, audio equipment, mobile communications, and general electronic appliances.

形名表記法 ORDERING CODE

1	3	4	5	6
形式	形状寸法(L×D)(mm以下)	リード加工形状 (mm)	公称インダクタンス (μH)	インダクタンス許容差[%]
LA アキシャルインダクタ	02 3.4×2.3 (LAL/LAP) 3.6×2.4 (LAN)	KB フォーミング単品(04タイプ) KH フォーミング単品(03タイプ) KR フォーミング単品(02タイプ) NA ストレート単品 SK 縦形フォーミング TA アキシャルつづらテーピング26.0幅 TB アキシャルつづらテーピング52.0幅 VA 縦形ラジアルテーピングピッチ2.5 VB 縦形ラジアルテーピングピッチ5.0 VD ラジアルテーピング	例 ※R=小数点 1R5 1.5 120 12	J ±5 K ±10 M ±20
2				7
製品区分				当社管理記号
L△ 一般 N△ 高電流タイプ P△ 一般(リード線径0.45φmm) △=スペース				△△△△ 標準品 △=スペース



1	3	4	5	6
Type	Body size(L×D)(mm)	Lead configurations(mm)	Nominal inductance(μH)	Inductance tolerance(%)
LA Axial inductor	02 3.4×2.3 (LAL/LAP) 3.6×2.4 (LAN)	KB Formed lead/bulk(04 type) KH Formed lead/bulk(03 type) KR Formed lead/bulk(02 type) NA Axial lead/bulk SK Formed lead(hair pin)/bulk(04 type) TA Axial lead(26mm lead space) /ammo pack(02/03 type) TB Axial lead(52mm lead space) /ammo pack(all types) VA Formed lead(hair pin) /ammo pack(02 type) VB Formed lead(hair pin) /ammo pack(03 type) VD Formed lead/ammo pack(02 type)	example ※R=decimal point 1R5 1.5 120 12	J ±5 K ±10 M ±20
2				7
Product Specification				Internal code
L△ Standard type N△ High current type P△ Standard type (lead diameter:0.45mm) △=Blank space				△△△△ Standard product △=Blank space

外形寸法 EXTERNAL DIMENSIONS

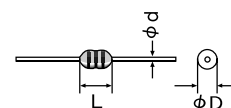

Type	Dimensions[mm](inch)			テーピング Taped		単品Bulk	
	L	φD	φd	ストレートStraight	フォーミングFormed	ストレートStraight	フォーミングFormed
LAL02	3.4max (0.134max)	2.3max (0.091max)	0.5±0.05 (0.020±0.002)	TB 	VD VA 	NA 	
LAP02	3.4max (0.134max)	2.3max (0.091max)	0.45±0.05 (0.018±0.002)	TA 			KR
LAN02	3.6max (0.142max)	2.4max (0.094max)		TA 	VB 	NA 	KH
LAL03	7.0max (0.276max)	2.6 ^{+0.1} _{-0.2} (0.102 ^{+0.004} _{-0.008})	※0.5±0.05 (0.020±0.002)	TA 	VB 	NA 	KH
LAL04	9.8max (0.386max)	4.0max (0.157max)	0.65±0.05 (0.026±0.002)	TB 		NA 	SK KB
LAL05	14.0max (0.551max)	5.5max (0.217max)	0.65±0.05 (0.026±0.002)	TB 			

※VB : 0.6±0.05
(0.024±0.002)

Unit : mm(inch)

概略バリエーション AVAILABLE INDUCTANCE RANGE

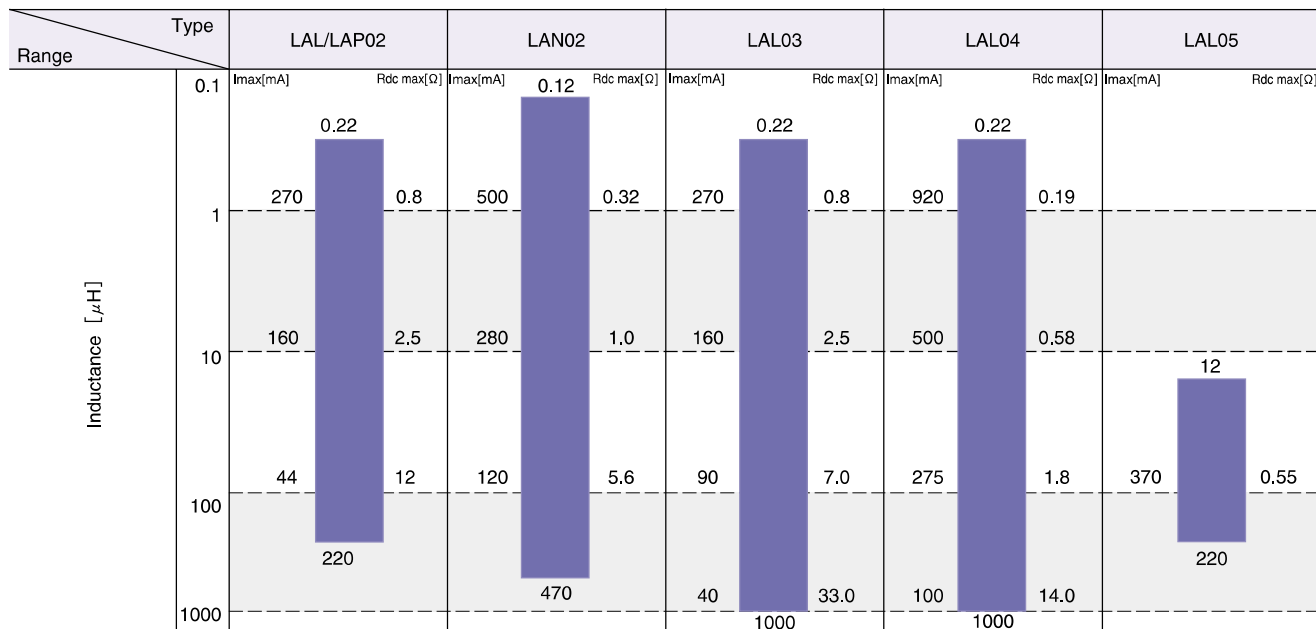

代表値 Examples	Inductance	Imax [mA]	Rdcmax [Ω]	Imax [mA]	Rdcmax [Ω]	Imax [mA]	Rdcmax [Ω]	Imax [mA]	Rdcmax [Ω]	Imax [mA]	Rdcmax [Ω]
	1 μH	270	0.8	500	0.32	270	0.8	920	0.19	—	
10 μH	160	2.5	280	1.0	160	2.5	500	0.58	—		
100 μH	44	12	120	5.6	90	7.0	275	1.8	370	0.55	—
1000 μH	—	—	—	—	40	33.0	100	14.0	—		

セレクションガイド Selection Guide

アイテム一覧 Part Numbers

特性図 Electrical Characteristics

梱包 Packaging

信頼性 Reliability Data

使用上の注意 Precautions

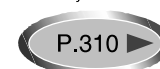
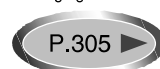

etc

LAL/LAP02

形名 Ordering code	公称 インダクタンス Inductance [μH]	インダクタンス 許容差 Inductance Tolerance	Q (min.)	数 Measuring frequency [MHz]	自己 数 Self-resonant frequency [MHz] (min.)	流 DC Resistance [Ω] (max.)	電流 Rated current [mA] (max.)	
LA□02○R22K	0.22	±10%	35.0	25.2	450.0	0.40	400.0	
LA□02○R27K	0.27				410.0	0.43	380.0	
LA□02○R33K	0.33				360.0	0.48	370.0	
LA□02○R39K	0.39				300.0	0.51	350.0	
LA□02○R47K	0.47				230.0	0.56	330.0	
LA□02○R56K	0.56				210.0	0.61	320.0	
LA□02○R68K	0.68				190.0	0.67	310.0	
LA□02○R82K	0.82				170.0	0.74	290.0	
LA□02○1R0K	1.0				150.0	0.80	270.0	
LA□02○1R2K	1.2				110.0	0.9	260.0	
LA□02○1R5K	1.5		80.0	1.0	250.0			
LA□02○1R8K	1.8		60.0	1.1	240.0			
LA□02○2R2K	2.2		45.0	1.2	230.0			
LA□02○2R7K	2.7		40.0	1.3	220.0			
LA□02○3R3K	3.3		38.0	1.4	210.0			
LA□02○3R9K	3.9		35.0	1.6	200.0			
LA□02○4R7K	4.7		32.0	1.7	190.0			
LA□02○5R6K	5.6		30.0	1.9	180.0			
LA□02○6R8K	6.8		28.0	2.0	175.0			
LA□02○8R2K	8.2		26.0	2.2	165.0			
LA□02○100K	10.0		24.0	2.5	160.0			
LA□02○120K	12.0		22.0	2.5	150.0			
LA□02○150K	15.0		20.0	2.8	145.0			
LA□02○180K	18.0		18.0	3.1	140.0			
LA□02○220K	22.0		17.0	3.4	130.0			
LA□02○270K	27.0		16.0	4.3	80.0			
LA□02○330K	33.0		14.0	4.7	76.0			
LA□02○390K	39.0		13.0	5.2	74.0			
LA□02○470K	47.0		12.0	5.8	70.0			
LA□02○560K	56.0		11.0	6.4	68.0			
LA□02○680K	68.0		10.0	7.2	64.0			
LA□02○820K	82.0		9.5	11.0	46.0			
LA□02○101K	100.0		9.0	12.0	44.0			
LA□02○121K	120.0		8.0	13.0	42.0			
LA□02○151K	150.0		6.0	16.0	39.0			
LA□02○181K	180.0		5.5	18.0	37.0			
LA□02○221K	220.0		5.0	20.0	35.0			
				40.0	7.96	110.0	0.9	260.0
						80.0	1.0	250.0
						60.0	1.1	240.0
			45.0			1.2	230.0	
			40.0			1.3	220.0	
			38.0			1.4	210.0	
			35.0			1.6	200.0	
			32.0			1.7	190.0	
			30.0			1.9	180.0	
			28.0			2.0	175.0	
			26.0	2.2	165.0			
			24.0	2.5	160.0			
			2.52	0.796	22.0	2.5	150.0	
					20.0	2.8	145.0	
					18.0	3.1	140.0	
					17.0	3.4	130.0	
					16.0	4.3	80.0	
					14.0	4.7	76.0	
					13.0	5.2	74.0	
					12.0	5.8	70.0	
					11.0	6.4	68.0	
					10.0	7.2	64.0	
			9.5	11.0	46.0			
			9.0	12.0	44.0			
			8.0	13.0	42.0			
			6.0	16.0	39.0			
			5.5	18.0	37.0			
			5.0	20.0	35.0			

形名の□に 製品区分記号(リード線径)が入り す (L:標準0.5mm, P:0.45mm)

形名の○に リード加工形状記号が入り す

□ Please specify the Product Specification(lead diameter)code. (L:standard 0.5mm or P:0.45mm)

○ Please specify the Lead configuration code.

LAN02

形名 Ordering code	公称 インダクタンス Inductance [μH]	インダクタンス 許容差 Inductance Tolerance	Q (min.)	数 Measuring frequency [MHz]	自己 数 Self-resonant frequency [MHz] (min.)	流 DC Resistance [Ω] (max.)	電流 Rated current [mA] (max.)
LAN02○R12K	0.12	±10%	50.0	25.2	500.0	0.12	850.0
LAN02○R15K	0.15				500.0	0.14	800.0
LAN02○R18K	0.18				500.0	0.15	760.0
LAN02○R22K	0.22				500.0	0.16	730.0
LAN02○R27K	0.27				500.0	0.18	690.0
LAN02○R33K	0.33				480.0	0.19	660.0
LAN02○R39K	0.39				430.0	0.21	640.0
LAN02○R47K	0.47				380.0	0.23	610.0
LAN02○R56K	0.56				350.0	0.25	580.0
LAN02○R68K	0.68				310.0	0.27	550.0
LAN02○R82K	0.82				270.0	0.29	520.0
LAN02○1R0J	1.0				±5%	40.0	7.96
LAN02○1R2J	1.2	210.0	0.35	480.0			
LAN02○1R5J	1.5	190.0	0.38	450.0			
LAN02○1R8J	1.8	140.0	0.42	430.0			
LAN02○2R2J	2.2	90.0	0.47	410.0			
LAN02○2R7J	2.7	70.0	0.52	390.0			
LAN02○3R3J	3.3	50.0	0.57	370.0			
LAN02○3R9J	3.9	35.0	0.63	360.0			
LAN02○4R7J	4.7	32.0	0.69	340.0			
LAN02○5R6J	5.6	30.0	0.75	320.0			
LAN02○6R8J	6.8	28.0	0.84	310.0			
LAN02○8R2J	8.2	26.0	0.92	290.0			
LAN02○100J	10.0	24.0	1.0	280.0			
LAN02○120J	12.0	22.0	1.0	280.0			
LAN02○150J	15.0	20.0	1.2	265.0			
LAN02○180J	18.0	18.0	1.3	250.0			
LAN02○220J	22.0	17.0	1.5	235.0			
LAN02○270J	27.0	15.0	1.7	220.0			
LAN02○330J	33.0	14.0	2.2	180.0			
LAN02○390J	39.0	13.0	2.4	170.0			
LAN02○470J	47.0	12.0	2.8	160.0			
LAN02○560J	56.0	10.0	4.1	140.0			
LAN02○680J	68.0	9.2	4.5	130.0			
LAN02○820J	82.0	8.8	5.0	125.0			
LAN02○101J	100.0	8.0	5.6	120.0			
LAN02○121J	120.0	50.0	2.52	6.6	9.2	90.0	
LAN02○151J	150.0			5.8	10.5	85.0	
LAN02○181J	180.0			5.4	11.5	80.0	
LAN02○221J	220.0			4.8	13.0	75.0	
LAN02○271J	270.0			3.6	16.0	70.0	
LAN02○331J	330.0			3.4	18.0	66.0	
LAN02○391J	390.0		3.2	20.0	63.0		
LAN02○471J	470.0		3.0	22.0	60.0		

形名の○に リード加工形状記号が入り ます
 ○ Please specify the Lead configuration code.

LAL03

形名 Ordering code	公称 インダクタンス Inductance [μH]	インダクタンス 許容差 Inductance Tolerance	Q (min.)	数 Measuring frequency (MHz)	自己 数 Self-resonant frequency (MHz) (min.)	流 DC Resistance [Ω] (max.)	電流 Rated current (mA) (max.)
LAL03○R22M	0.22	±20%	35.0	25.2	450.0	0.40	400.0
LAL03○R27M	0.27				410.0	0.43	380.0
LAL03○R33M	0.33				360.0	0.48	370.0
LAL03○R39M	0.39				300.0	0.51	350.0
LAL03○R47M	0.47				230.0	0.56	330.0
LAL03○R56M	0.56				210.0	0.61	320.0
LAL03○R68M	0.68				190.0	0.67	310.0
LAL03○R82M	0.82		170.0		0.74	290.0	
LAL03○1R0M	1.0		150.0		0.80	270.0	
LAL03○1R2M	1.2		144.0		0.90	260.0	
LAL03○1R5M	1.5		131.0		1.0	250.0	
LAL03○1R8M	1.8		121.0		1.1	240.0	
LAL03○2R2M	2.2		110.0		1.2	230.0	
LAL03○2R7M	2.7		100.0		1.3	220.0	
LAL03○3R3K	3.3	±10%	50.0	7.96	94.0	1.4	210.0
LAL03○3R9K	3.9				65.0	1.6	200.0
LAL03○4R7K	4.7				56.0	1.7	190.0
LAL03○5R6K	5.6				48.0	1.9	180.0
LAL03○6R8K	6.8				37.0	2.0	175.0
LAL03○8R2K	8.2				25.0	2.2	165.0
LAL03○100K	10.0				21.0	2.5	160.0
LAL03○120K	12.0				19.0	2.5	150.0
LAL03○150K	15.0				17.0	2.8	145.0
LAL03○180K	18.0				13.0	3.1	140.0
LAL03○220K	22.0				9.6	3.4	130.0
LAL03○270K	27.0				7.2	3.8	125.0
LAL03○330K	33.0				6.3	4.1	120.0
LAL03○390K	39.0		6.3	4.5	115.0		
LAL03○470K	47.0		6.3	4.9	110.0		
LAL03○560K	56.0		6.2	5.3	105.0		
LAL03○680K	68.0		5.7	5.8	100.0		
LAL03○820K	82.0		5.3	6.3	95.0		
LAL03○101K	100.0		4.8	7.0	90.0		
LAL03○121K	120.0		3.8	13.0	90.0		
LAL03○151K	150.0		3.5	15.0	85.0		
LAL03○181K	180.0		3.3	16.0	80.0		
LAL03○221K	220.0		3.0	17.0	75.0		
LAL03○271K	270.0		2.8	19.0	65.0		
LAL03○331K	330.0		2.6	20.0	60.0		
LAL03○391K	390.0		2.4	22.0	55.0		
LAL03○471K	470.0	2.25	24.0	55.0			
LAL03○561K	560.0	2.10	26.0	50.0			
LAL03○681K	680.0	1.95	28.0	45.0			
LAL03○821K	820.0	1.85	30.0	40.0			
LAL03○102K	1000.0	1.40	33.0	40.0			

形名の○に リード加工形状記号が入り ます

○ Please specify the Lead configuration code.

LAL04

形名 Ordering code	公称 インダクタンス Inductance [μH]	インダクタンス 許容差 Inductance Tolerance	Q (min.)	数 Measuring frequency [MHz]	自己 数 Self-resonant frequency [MHz] (min.)	流 DC Resistance [Ω] (max.)	電流 Rated current [mA] (max.)
LAL04○R22M	0.22	±20%	45.0	25.2	300.0	0.10	1400.0
LAL04○R27M	0.27				270.0	0.11	1320.0
LAL04○R33M	0.33				250.0	0.12	1280.0
LAL04○R39M	0.39				230.0	0.13	1200.0
LAL04○R47M	0.47				220.0	0.14	1150.0
LAL04○R56M	0.56				200.0	0.15	1100.0
LAL04○R68M	0.68				190.0	0.16	1030.0
LAL04○R82M	0.82				172.0	0.17	980.0
LAL04○1R0M	1.0				157.0	0.19	920.0
LAL04○1R2M	1.2				144.0	0.21	880.0
LAL04○1R5M	1.5	131.0	0.23	830.0			
LAL04○1R8M	1.8	121.0	0.25	790.0			
LAL04○2R2M	2.2	±10%	55.0	7.96	110.0	0.28	750.0
LAL04○2R7M	2.7		60.0		100.0	0.30	720.0
LAL04○3R3K	3.3		65.0		94.0	0.34	670.0
LAL04○3R9K	3.9		70.0		65.0	0.37	640.0
LAL04○4R7K	4.7				56.0	0.39	620.0
LAL04○5R6K	5.6				48.0	0.43	590.0
LAL04○6R8K	6.8		75.0		37.0	0.48	550.0
LAL04○8R2K	8.2		80.0		25.0	0.52	530.0
LAL04○100K	10.0		65.0		21.0	0.58	500.0
LAL04○120K	12.0		50.0		2.52	19.0	0.63
LAL04○150K	15.0	17.0		0.72		460.0	
LAL04○180K	18.0	13.0		0.77		430.0	
LAL04○220K	22.0	9.6		0.84		410.0	
LAL04○270K	27.0	7.2		0.94		390.0	
LAL04○330K	33.0	55.0		6.3		1.03	370.0
LAL04○390K	39.0	50.0		6.3		1.12	350.0
LAL04○470K	47.0	45.0		6.3		1.22	340.0
LAL04○560K	56.0	40.0		6.2		1.34	320.0
LAL04○680K	68.0	35.0		5.7		1.47	305.0
LAL04○820K	82.0	30.0	5.3	1.62	290.0		
LAL04○101K	100.0	55.0	4.8	1.80	275.0		
LAL04○121K	120.0	65.0	0.796	55.0	3.8	3.70	185.0
LAL04○151K	150.0			45.0	3.5	4.20	175.0
LAL04○181K	180.0			50.0	3.3	4.60	165.0
LAL04○221K	220.0			55.0	3.0	5.10	155.0
LAL04○271K	270.0			60.0	2.8	5.80	145.0
LAL04○331K	330.0				2.6	6.40	137.0
LAL04○391K	390.0				2.4	7.00	133.0
LAL04○471K	470.0			2.25	7.70	126.0	
LAL04○561K	560.0			2.10	8.50	120.0	
LAL04○681K	680.0			55.0	1.95	9.40	113.0
LAL04○821K	820.0	1.85	10.50		105.0		
LAL04○102K	1000.0	50.0	1.40		14.00	100.0	

形名の○に リード加工形状記号が入り ます
○ Please specify the Lead configuration code.

LAL05

形名 Ordering code	公称 インダクタンス Inductance [μH]	インダクタンス 許容差 Inductance Tolerance	Q (min.)	数 Measuring frequency [MHz]	自己 数 Self-resonant frequency [MHz] (min.)	流 DC Resistance [Ω] (max.)	電流 Rated current [A] (max.)
LAL05○120K	12.0	±10%	30.0	2.52	11.0	0.15	1.05
LAL05○150K	15.0				10.0	0.16	1.00
LAL05○180K	18.0				9.0	0.18	0.82
LAL05○220K	22.0				8.0	0.19	0.80
LAL05○270K	27.0				7.0	0.21	0.70
LAL05○330K	33.0				6.0	0.27	0.60
LAL05○390K	39.0		20.0	2.52	5.5	0.30	0.54
LAL05○470K	47.0				5.0	0.32	0.52
LAL05○560K	56.0				4.5	0.36	0.49
LAL05○680K	68.0				4.0	0.40	0.45
LAL05○820K	82.0				3.7	0.43	0.40
LAL05○101K	100.0				3.3	0.55	0.37
LAL05○121K	120.0		30.0	0.796	3.0	1.10	0.31
LAL05○151K	150.0				2.6	1.20	0.27
LAL05○181K	180.0				2.3	1.30	0.25
LAL05○221K	220.0				2.0	1.40	0.22

形名の○に リード加工形状記号が入ります

○ Please specify the Lead configuration code.

流量特性例 DC Bias characteristics(Measured by HP4262A)

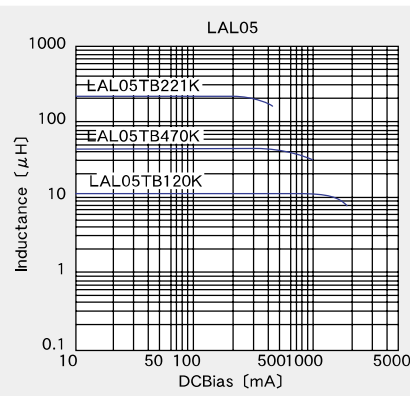
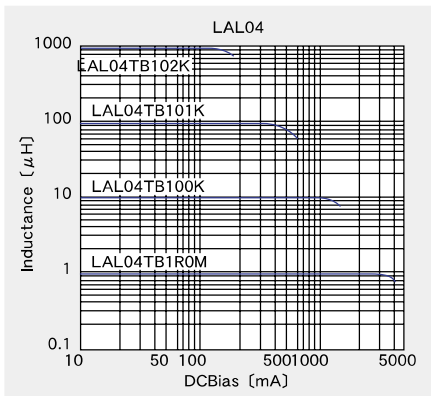
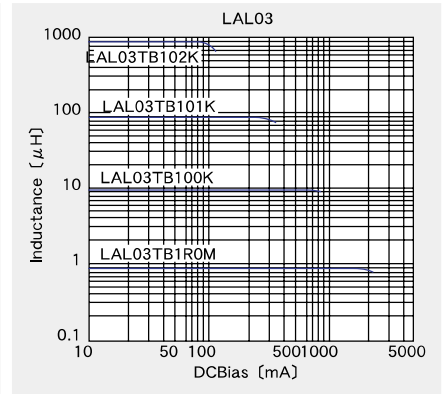
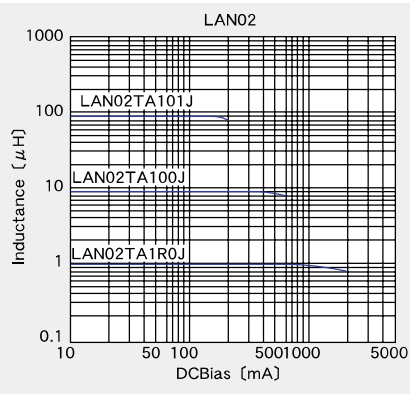
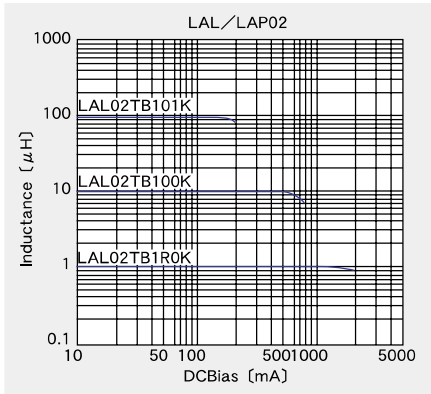

特性例 Temperature characteristics(Measured by HP4342A)

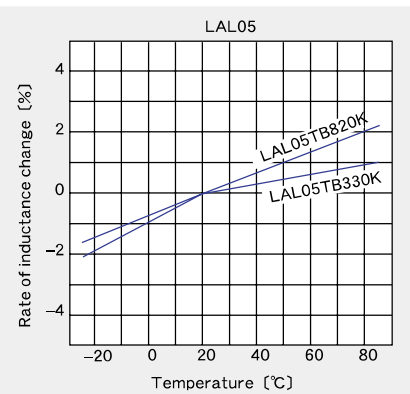
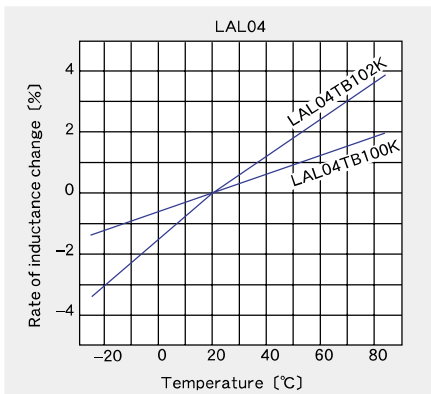
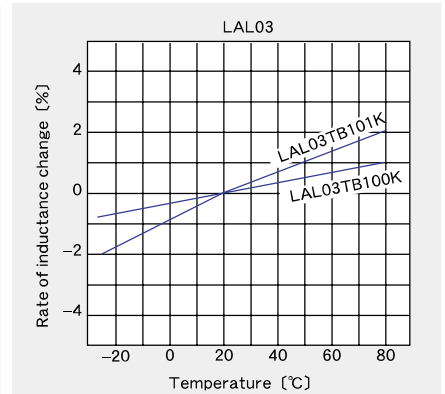
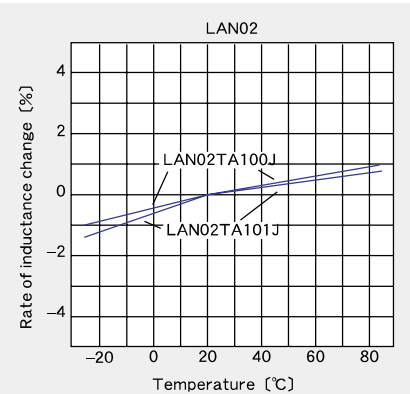
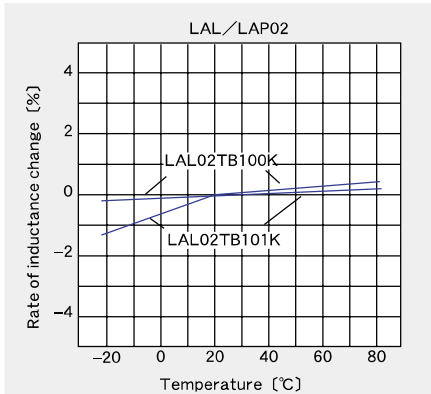

Q- 数特性例 Q-Characteristics(Measured by HP4342A)

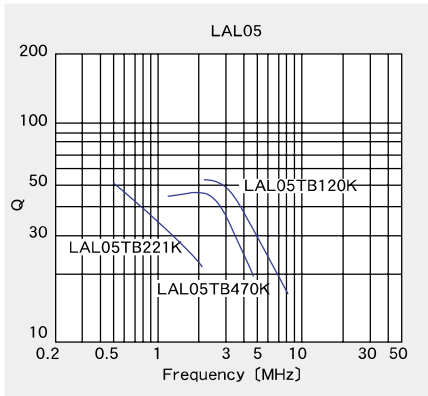
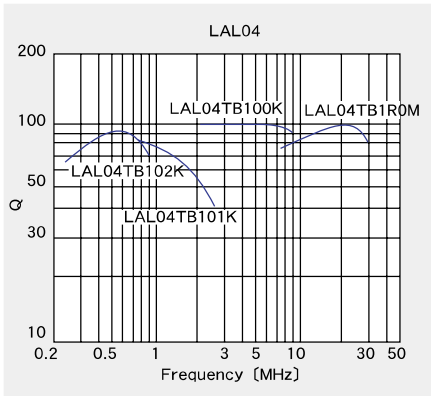
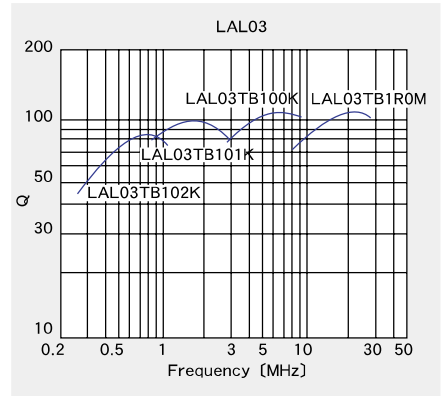
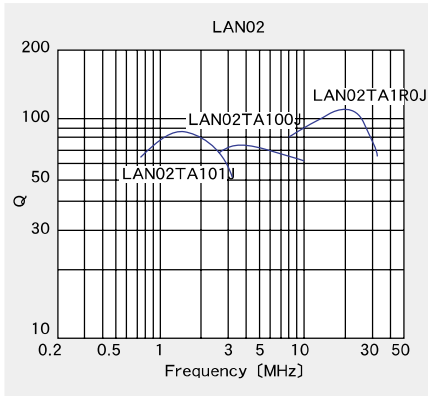
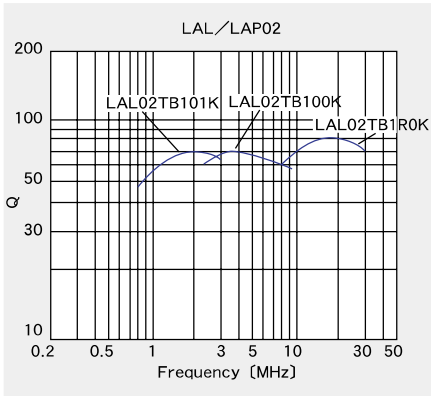

AXIAL LEADED INDUCTORS

Item	Specified Value			Test Methods and Remarks												
	LA02 type · LA03 type	LA04 type	LA05 type													
1. Operating Temperature Range	-25°C~+105°C			Including self-generated heat.												
2. Storage Temperature Range	-40°C~+85°C			—												
3. Q	Within the specified tolerance			Measuring equipment : LCR meter (HP4285A+42851A or its equivalent) Measuring frequency : Specified frequency												
4. Self Resonant Frequency	Within the specified tolerance			Measuring equipment : Network analyzer (Anritsu MS620J or its equivalent)												
5. DC Resistance	Within the specified tolerance			Measuring equipment : low ohmmeter (A&D AD5812 or its equivalent)												
6. DC Bias Characteristic	ΔL/L→Within -10%			Measure inductance with application of rated current using LCR meter to compare it with the initial value.												
7. Temperature Characteristics	ΔL/L→Within ±5%			Change of maximum inductance deviation in step 1 to 5 <table border="1"> <thead> <tr> <th>Step</th> <th>Temperature (C)</th> </tr> </thead> <tbody> <tr> <td>1</td> <td>20</td> </tr> <tr> <td>2</td> <td>-25 (Minimum operating temperature)</td> </tr> <tr> <td>3</td> <td>20 (Reference temperature)</td> </tr> <tr> <td>4</td> <td>+85 (Maximum operating temperature)</td> </tr> <tr> <td>5</td> <td>20</td> </tr> </tbody> </table>	Step	Temperature (C)	1	20	2	-25 (Minimum operating temperature)	3	20 (Reference temperature)	4	+85 (Maximum operating temperature)	5	20
Step	Temperature (C)															
1	20															
2	-25 (Minimum operating temperature)															
3	20 (Reference temperature)															
4	+85 (Maximum operating temperature)															
5	20															
8. Inductance	Within the specified tolerance			Measuring equipment : LCR meter (HP4285A+42851A or its equivalent) Measuring frequency : Specified frequency												
9. Rated Current	Within the specified tolerance			The maximum DC value having inductance decrease within 10% and temperature increase within 20°C by the application of DC bias.												
10. Terminal Strength	Tensile	No abnormality such as cutoff or looseness of lead.		Apply the stated tensile force progressively in the direction to draw terminal. <table border="1"> <thead> <tr> <th>Nominal wire diameter(mm)</th> <th>Tensile force(N)</th> <th>Duration(S)</th> </tr> </thead> <tbody> <tr> <td>0.43<φd≤0.65</td> <td>25</td> <td>5</td> </tr> </tbody> </table>	Nominal wire diameter(mm)	Tensile force(N)	Duration(S)	0.43<φd≤0.65	25	5						
	Nominal wire diameter(mm)	Tensile force(N)	Duration(S)													
0.43<φd≤0.65	25	5														
Bending	No abnormality such as cutoff or looseness of lead.		Suspend a mass at the end the terminal, incline the body through angle of 90° and return it to initial position. This operation is done over a period of 2-3 sec. Then a second bend in the opposite direction shall be made. Number of bends : Two times <table border="1"> <thead> <tr> <th>Nominal wire diameter(mm)</th> <th>Bending force(N)</th> <th>Mass weight(kg)</th> </tr> </thead> <tbody> <tr> <td>0.3<φd≤0.5</td> <td>2.5</td> <td>0.25</td> </tr> <tr> <td>0.5<φd≤0.8</td> <td>5</td> <td>0.50</td> </tr> </tbody> </table>	Nominal wire diameter(mm)	Bending force(N)	Mass weight(kg)	0.3<φd≤0.5	2.5	0.25	0.5<φd≤0.8	5	0.50				
Nominal wire diameter(mm)	Bending force(N)	Mass weight(kg)														
0.3<φd≤0.5	2.5	0.25														
0.5<φd≤0.8	5	0.50														
11. Body Strength	No abnormality such as damage			LA02 Applied force : 30N Duration : 10 sec. Speed : Shall attain to specified force in 2 sec. LA03, LA04, LA05 Applied force : 50N Duration : 10 sec. Speed : Shall attain to specified force in 2 sec.												
12. Resistance to Vibration	ΔL/L→Within±5% Q→30 min.	ΔL/L→ Within±5% ΔQ/Q→ Within±10%	ΔL/L→Within±5% Q→15 min.	According to JIS C 5102 clause 8.2. Vibration type : A Directions : 2 hrs each in X, Y, and Z directions Total : 6 hrs Frequency range : 10 to 55 to 10 Hz (1 min.) Amplitude : 1.5mm Mounting method : Soldering onto printed board Recovery : At least 1 hr of recovery under the standard condition after the test, followed by the measurement within 2 hrs.												
13. Resistance to Shock	No significant abnormality in appearance	No significant abnormality in appearance	No significant abnormality in appearance	Drop test Impact material : Concrete or vinyl tile Height : 1m Total number of drops : 10 times												
14. Solderability	At least 75% of terminal electrode is covered by new solder.			Solder temperature : 230±5°C Duration : 2±0.5 sec.												
15. Resistance to Soldering Heat	No significant abnormality in appearance.	No significant abnormality in appearance.	ΔL/L→Within±5% Q→15 min.	Solder temperature : 260±5°C (LA02) 270±5°C (LA03, LA04, LA05) Duration : 5±0.5sec. Once Immersed conditions : Inserted into substrate with t=1.6mm Recovery : At least 1 hr of recovery under the standard condition after the test, followed by the measurement within 2 hrs.												

AXIAL LEADED INDUCTORS

Item	Specified Value			Test Methods and Remarks															
	LA02 type · LA03 type	LA04 type	LA05 type																
16. Resistance to Solvent	Please avoid the ultrasonic cleaning of this product.																		
17. Thermal Shock	$\Delta L/L \rightarrow$ Within $\pm 10\%$ Q \rightarrow 30 min.	$\Delta L/L \rightarrow$ Within $\pm 10\%$ $\Delta Q/Q \rightarrow$ Within $\pm 30\%$	$\Delta L/L \rightarrow$ Within $\pm 10\%$ Q \rightarrow 15 min.	Conditions for 1 cycle <table border="1"> <thead> <tr> <th>Step</th> <th>Temperature (C)</th> <th>Duration (min.)</th> </tr> </thead> <tbody> <tr> <td>1</td> <td>-25^{+0}_{-3}</td> <td>30 ± 3</td> </tr> <tr> <td>2</td> <td>Room temperature</td> <td>Within 3</td> </tr> <tr> <td>3</td> <td>$+85^{+2}_{-0}$</td> <td>30 ± 3</td> </tr> <tr> <td>4</td> <td>Room temperature</td> <td>Within 3</td> </tr> </tbody> </table> Number of cycles : 5 Recovery : At least 1 hr of recovery under the standard condition after the removal from test chamber, followed by the measurement within 2 hrs.	Step	Temperature (C)	Duration (min.)	1	-25^{+0}_{-3}	30 ± 3	2	Room temperature	Within 3	3	$+85^{+2}_{-0}$	30 ± 3	4	Room temperature	Within 3
Step	Temperature (C)	Duration (min.)																	
1	-25^{+0}_{-3}	30 ± 3																	
2	Room temperature	Within 3																	
3	$+85^{+2}_{-0}$	30 ± 3																	
4	Room temperature	Within 3																	
18. Damp Heat	$\Delta L/L \rightarrow$ Within $\pm 10\%$ Q \rightarrow 30 min.	$\Delta L/L \rightarrow$ Within $\pm 10\%$ $\Delta Q/Q \rightarrow$ Within $\pm 30\%$	$\Delta L/L \rightarrow$ Within $\pm 10\%$ Q \rightarrow 15 min.	Temperature : $40 \pm 2^{\circ}\text{C}$ Humidity : 90 to 95%RH Duration : 1000 hrs Recovery : At least 1 hr of recovery under the standard condition after the removal from test chamber, followed by the measurement within 2 hrs.															
19. Loading under Damp Heat	$\Delta L/L \rightarrow$ Within $\pm 10\%$ Q \rightarrow 30 min.	$\Delta L/L \rightarrow$ Within $\pm 10\%$ $\Delta Q/Q \rightarrow$ Within $\pm 30\%$	$\Delta L/L \rightarrow$ Within $\pm 10\%$ Q \rightarrow 15 min.	Temperature : $40 \pm 2^{\circ}\text{C}$ Humidity : 90 to 95%RH Duration : 1000 hrs Applied current : Rated current Recovery : At least 1 hr of recovery under the standard condition after the removal from test chamber, followed by the measurement within 2 hrs.															
20. Loading at High Temperature	$\Delta L/L \rightarrow$ Within $\pm 10\%$ Q \rightarrow 30 min.	$\Delta L/L \rightarrow$ Within $\pm 10\%$ $\Delta Q/Q \rightarrow$ Within $\pm 30\%$	$\Delta L/L \rightarrow$ Within $\pm 10\%$ Q \rightarrow 15 min.	Temperature : $85 \pm 2^{\circ}\text{C}$ Duration : 1000 hrs Applied current : Rated current Recovery : At least 1 hr of recovery under the standard condition after the removal from test chamber, followed by the measurement within 2 hrs.															
21. Low Temperature Life Test	$\Delta L/L \rightarrow$ Within $\pm 10\%$ Q \rightarrow 30 min.	$\Delta L/L \rightarrow$ Within $\pm 10\%$ $\Delta Q/Q \rightarrow$ Within $\pm 30\%$	$\Delta L/L \rightarrow$ Within $\pm 10\%$ Q \rightarrow 15 min.	Temperature : $-25 \pm 2^{\circ}\text{C}$ Duration : 1000 hrs Recovery : At least 1 hr of recovery under the standard condition after the removal from test chamber, followed by the measurement within 2 hrs.															

Note on standard condition: "standard condition" referred to herein is defined as follows:

5 to 35°C of temperature, 45 to 85% relative humidity and 86 to 106kPa of air pressure.

When there are questions concerning measurement results:

In order to provide correlation data, the test shall be conducted under condition of $20 \pm 2^{\circ}\text{C}$ of temperature, 45 to 85% relative humidity and 86 to 106kPa of air pressure.

Unless otherwise specified, all the tests are conducted under the "standard condition."

標準数量 Standard quantity

①アキシャルリードのテーピング Taping for Straight Leads

Type	リード加工記号 Lead Configuration code	標準数量(pcs.) Standard quantity
LAL02	TB	2,000
LAP02	TA	2,000
LAN02	TA	2,000
LAL03	TA・TB	2,000
LAL04	TB	2,500
LAL05	TB	2,000

②アキシャルリードの縦テーピング Taping for Formed Leads

Type	リード加工記号 Lead Configuration code	標準数量(pcs.) Standard quantity
LAL02	VD・VA	2,000
LAL03	VB	2,000

③バルク(づめ) Bulk

Type	リード加工記号 Lead Configuration code	標準数量(pcs.) Standard quantity
LAL02	NA	500
LAP02	KR	2,000
LAN02	KR	500
LAL03	NA・KH	500
LAL04	NA・KB・SK	500

NA形状

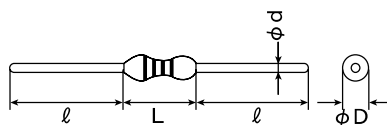

Type	寸法 Dimensions				小挿入ピッチ Minimum insertion pitch
	ϕD	L	ϕd	l	
LAL02	2.3max (0.091max)	3.4max (0.134max)	0.50±0.05 (0.020±0.002)	24±2.0 (0.945±0.079)	5.0 (0.197)
LAL03	2.6 ^{+0.1} _{-0.2} (0.102 ^{+0.004} _{-0.008})	7.0max (0.276max)	0.50±0.05 (0.020±0.002)	22±2.0 (0.866±0.079)	10.0 (0.394)
LAL04	4.0max (0.157max)	9.8max (0.386max)	0.65±0.05 (0.026±0.002)	20±2.0 (0.787±0.079)	12.5 (0.492)

Unit : mm(inch)

KR/KH/KB形状

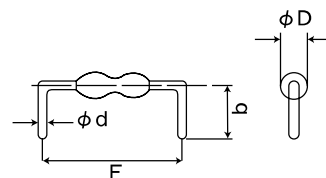

Type	リード加工 形状記号 Lead configuration code	寸法 Dimensions			
		ϕD	F	ϕd	b
LAP02	KR	2.3max (0.091max)	5.0±0.5 (0.197±0.020)	0.45±0.05 (0.018±0.002)	7.0±1.0 (0.276±0.039)
LAN02	KR	2.4max (0.094max)	5.0±0.5 (0.197±0.020)	0.45±0.05 (0.018±0.002)	7.0±1.0 (0.276±0.039)
LAL03	KH	2.6 ^{+0.1} _{-0.2} (0.102 ^{+0.004} _{-0.008})	10.0±0.5 (0.394±0.020)	0.50±0.05 (0.020±0.002)	6.5±0.5 (0.256±0.020)
LAL04	KB	4.0max (0.157max)	12.5±1.0 (0.492±0.039)	0.65±0.05 (0.026±0.002)	6.0±0.5 (0.236±0.020)

Unit : mm(inch)

SK形状

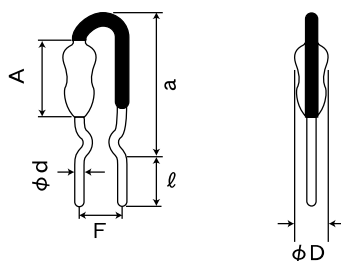

Type	寸法 Dimensions					
	A	a	ϕD	F	ϕd	l
LAL04	9.8max (0.386max)	14.0max (0.551max)	4.0max (0.157max)	5.0±1.5 (0.197±0.059)	0.65±0.05 (0.026±0.002)	6.0±1.0 (0.236±0.039)

Unit : mm(inch)

TA (a : 26mm lead space)形状
(1.02 inch)

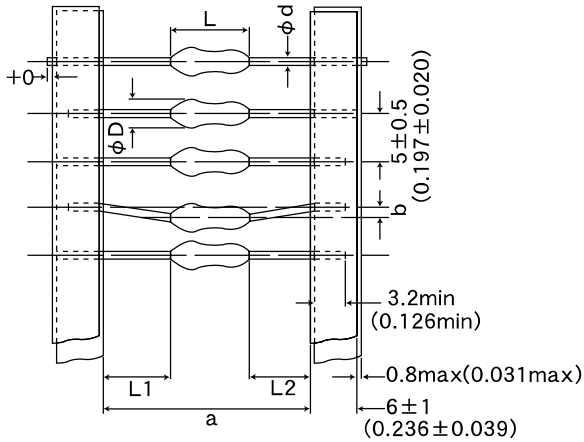

TB (a : 52mm lead space)形状
(2.05 inches)

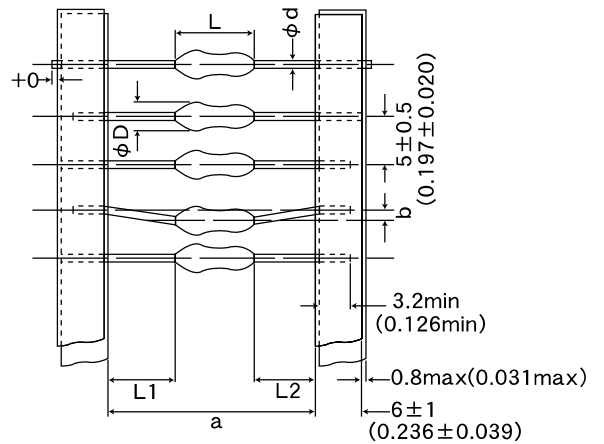

Type	寸法 Dimensions						小挿入 ピッチ Minimum insertion pitch
	ϕD	L	a	b	$ L_1 - L_2 $	ϕd	
LAP02	2.3max (0.091max)	3.4max (0.134max)	$26^{+0.5}_{-0}$ (1.02 ^{+0.020} ₋₀)	0.8max (0.031max)	0.5max (0.020max)	0.45 ± 0.05 (0.018 \pm 0.002)	5.0 (0.197)
LAN02	2.4max (0.094max)	3.6max (0.142max)	$26^{+0.5}_{-0}$ (1.02 ^{+0.020} ₋₀)	0.8max (0.031max)	0.5max (0.020max)	0.45 ± 0.05 (0.018 \pm 0.002)	5.0 (0.197)
LAL03	$2.6^{+0.1}_{-0.2}$ (0.102 ^{+0.004} _{-0.008})	7.0max (0.276max)	$26^{+1}_{-0.5}$ (1.02 ^{+0.039} _{-0.020})	0.8max (0.031max)	1.0max (0.039max)	0.5 ± 0.05 (0.020 \pm 0.002)	10.0 (0.394)

Unit : mm(inch)

Type	寸法 Dimensions						小挿入 ピッチ Minimum insertion pitch
	ϕD	L	a	b	$ L_1 - L_2 $	ϕd	
LAL02	2.3max (0.091max)	3.4max (0.134max)	52^{+2}_{-1} (2.05 ^{+0.079} _{-0.039})	1.2max (0.047max)	1.0max (0.039max)	0.5 ± 0.05 (0.020 \pm 0.002)	5.0 (0.197)
LAL03	$2.6^{+0.1}_{-0.2}$ (0.102 ^{+0.004} _{-0.008})	7.0max (0.276max)	52^{+2}_{-1} (2.05 ^{+0.079} _{-0.039})	1.2max (0.047max)	1.0max (0.039max)	0.5 ± 0.05 (0.020 \pm 0.002)	10.0 (0.394)
LAL04	4.0max (0.157max)	9.8max (0.386)	52^{+2}_{-1} (2.05 ^{+0.079} _{-0.039})	1.2max (0.047max)	1.0max (0.039max)	0.65 ± 0.05 (0.026 \pm 0.002)	12.5 (0.492)
LAL05	5.5max (0.217max)	14.0max (0.551)	52^{+2}_{-1} (2.05 ^{+0.079} _{-0.039})	1.2max (0.047max)	1.0max (0.039max)	0.65 ± 0.05 (0.026 \pm 0.002)	17.5 (0.689)

Unit : mm(inch)

VD形状

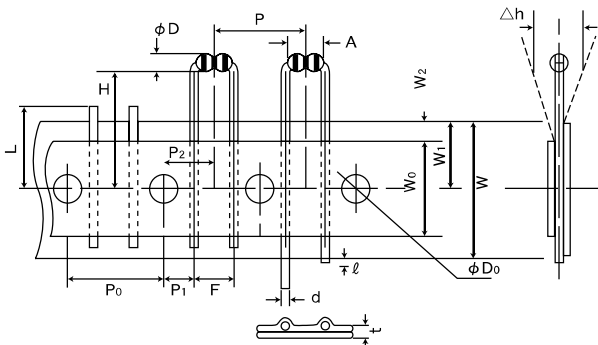

VA形状

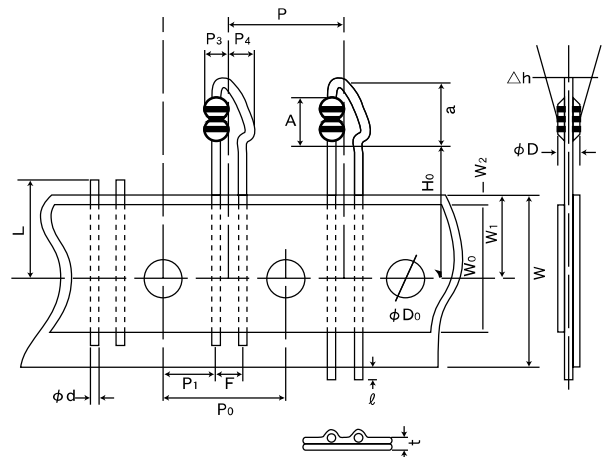

Type	記号 Symbol	寸法 Dimensions	記号 Symbol	寸法 Dimensions
LAL02	A	3.9max (0.154max)	W	18.0 ^{+1.0} _{-0.5} (0.709 ^{+0.039} _{-0.020})
	φD	2.3max (0.091max)	W ₀	12.5min (0.492min)
	H	19.5±0.5 (0.768±0.020)	W ₁	9.0 ^{+0.75} _{-0.5} (0.354 ^{+0.030} _{-0.020})
	P	12.7±1.0 (0.500±0.039)	W ₂	3.0max (0.118max)
	P ₀	12.7±0.3 (0.500±0.012)	ℓ	2.0max (0.079max)
	P ₁	3.85±0.7 (0.152±0.028)	φD ₀	4.0±0.3 (0.157±0.012)
	P ₂	6.35±0.5 (0.250±0.020)		
	F	5.08±0.5 (0.200±0.020)	φd	0.50±0.05 (0.020±0.002)
	Δh	0±1.0 (0±0.039)	L	11.0max (0.433max)
—	—	t	0.5±0.2 (0.020±0.008)	

Unit : mm(inch)

Type	記号 Symbol	寸法 Dimensions	記号 Symbol	寸法 Dimensions
LAL02	A	3.9max (0.154max)	W	18.0 ^{+1.0} _{-0.5} (0.709 ^{+0.039} _{-0.020})
	a	6.5max (0.256max)	W ₀	12.5min (0.492min)
	φD	2.3max (0.091max)	W ₁	9.0 ^{+0.75} _{-0.5} (0.354 ^{+0.030} _{-0.020})
	H ₀	16.0±1.0 (0.630±0.039)	W ₂	3.0max (0.118max)
	P	12.7±1.0 (0.500±0.039)	ℓ	2.0max (0.079max)
	P ₀	12.7±0.3 (0.500±0.012)	φD ₀	4.0±0.3 (0.157±0.012)
	P ₁	5.1±0.7 (0.201±0.028)	φd	0.50±0.05 (0.020±0.002)
	P ₂	6.35±0.5 (0.250±0.020)		
	P ₃	3.0max (0.118max)	L	11.0max (0.433max)
	P ₄	3.0max (0.118max)		
	F	2.5±0.5 (0.098±0.020)	t	0.5±0.2 (0.020±0.008)
	Δh	0±1.0 (0±0.039)	—	—

Unit : mm(inch)

VB形状

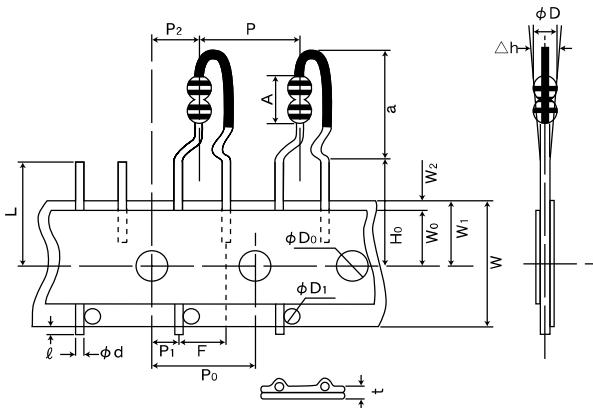

Type	記号 Symbol	寸法 Dimensions	記号 Symbol	寸法 Dimensions
LAL03	A	7.0max (0.276max)	W	18.0 ^{+1.0} _{-0.5} (0.709 ^{+0.039} _{-0.020})
	a	12.5max (0.492max)	W ₀	12.5min (0.492min)
	ϕD	2.7max (0.106max)	W ₁	9.0 ^{+0.75} _{-0.5} (0.354 ^{+0.030} _{-0.020})
	H ₀	16.0±0.5 (0.630±0.020)	W ₂	3.0max (0.118max)
	P	12.7±1.0 (0.500±0.039)	ℓ	1.0max (0.039max)
	P ₀	12.7±0.3 (0.500±0.012)	ϕD_0	4.0±0.2 (0.157±0.008)
	P ₁	3.85±0.7 (0.152±0.028)	ϕD_1	3.5max (0.138max)
	P ₂	6.35±1.0 (0.250±0.039)	ϕd	0.60±0.05 (0.024±0.002)
	F	5.0±1.0 (0.197±0.039)	L	11.0max (0.433max)
Δh	0±2.0 (0±0.079)	t	0.7±0.2 (0.028±0.008)	

Unit : mm(inch)