

7.6 mm (0.3 inch) Micro Bright Seven Segment Displays

Technical Data

HDSP-740x Series
HDSP-750x Series
HDSP-780x Series
HDSP-A15x Series
HDSP-A40x Series

Features

- **Available with Colon for Clock Display**
- **Compact Package**
0.300 x 0.500 inches
Leads on 2.54 mm (0.1 inch) Centers
- **Choice of Colors**
AlGaAs Red, High Efficiency Red, Yellow, Green, Orange
- **Excellent Appearance**
Evenly Lighted Segments
Mitered Corners on Segments
Surface Color Gives Optimum Contrast
 $\pm 50^\circ$ Viewing Angle
- **Design Flexibility**
Common Anode or Common Cathode
- **Right Hand Decimal Point ± 1 . Overflow Character**
- **Categorized for Luminous Intensity**
Yellow and Green Categorized for Color
Use of Like Categories Yields a Uniform Display
- **High Light Output**
- **High Peak Current**
- **Excellent for Long Digit String Multiplexing**
- **Intensity and Color Selection Available**
See Intensity and Color Selected Displays Data Sheet
- **Sunlight Viewable AlGaAs**

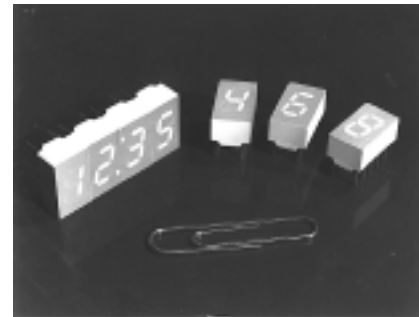

Description

The 7.6 mm (0.3 inch) LED seven segment displays are designed for viewing distances up to 3 metres (10 feet). These devices use an industry standard size package and pinout. Both the numeric and

Devices

Orange HDSP-	AlGaAs ^[1] HDSP-	HER ^[1] HDSP-	Yellow ^[1] HDSP-	Green ^[1] HDSP-	Description	Package Drawing
A401	A151	7501	7401	7801	Common Anode Right Hand Decimal	A
		7502	7402	7802	Common Anode Right Hand Decimal, Colon	B
A403	A153	7503	7403	7803	Common Cathode Right Hand Decimal	C
		7504	7404	7804	Common Cathode Right Hand Decimal, Colon	D
	A157	7507	7407	7807	Common Anode ± 1 . Overflow	E
	A158	7508	7408	7808	Common Cathode ± 1 . Overflow	F

Note:

1. These displays are recommended for high ambient light operation. Please refer to the HDSP-A10X AlGaAs, HDSP-335X HER, HDSP-A80X Yellow, and HDSP-A90X Green data sheet for low current operation.

± 1. overflow devices feature a right hand decimal point. All devices are available as either common anode or common cathode.

These displays are ideal for most applications. Pin for pin equivalent displays are also available in a low current design. The low current displays are ideal for

portable applications. For additional information see the Low Current Seven Segment Displays.

Part Numbering System

5082 -X X X X-X X X X X
 HDSP-X X X X-X X X X X

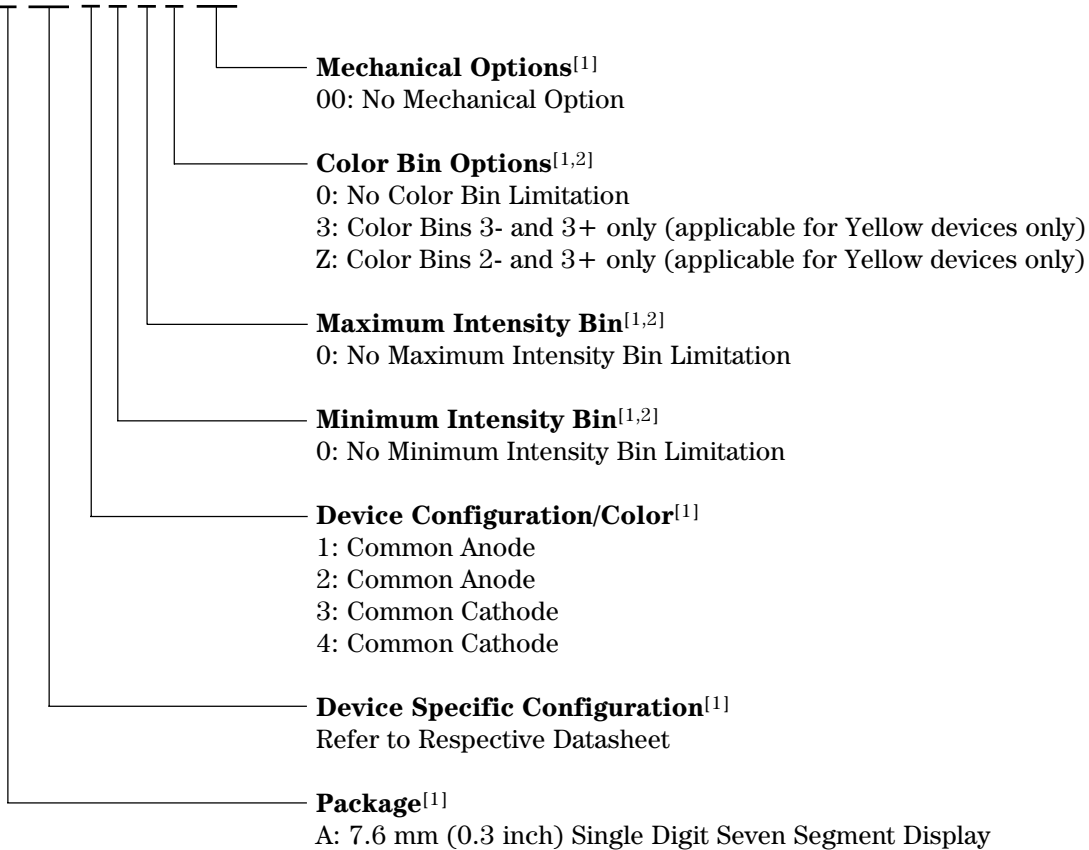

Notes:

- For codes not listed in the figure above, please refer to the respective datasheet or contact your nearest Agilent representative for details.
- Bin options refer to shippable bins for a part number. Color and Intensity Bins are typically restricted to 1 bin per tube (exceptions may apply). Please refer to respective datasheet for specific bin limit information.

Package Dimensions

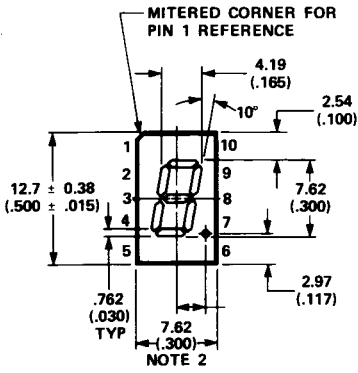

A, C

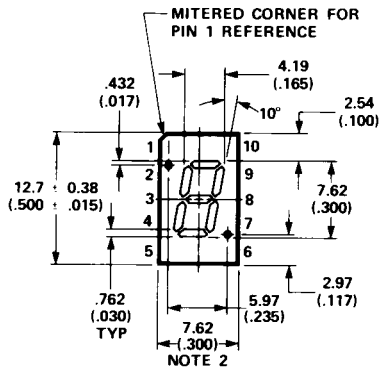

B, D

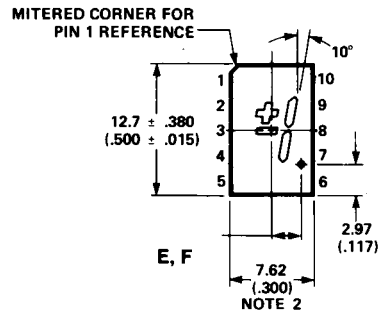
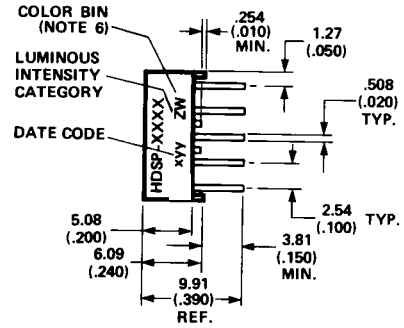
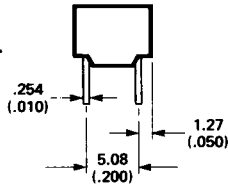

E, F

- NOTES:
 1. ALL DIMENSIONS IN MILLIMETRES (INCHES).
 2. MAXIMUM.
 3. ALL UNTOLERANCED DIMENSIONS ARE FOR REFERENCE ONLY.
 4. REDUNDANT ANODES.
 5. REDUNDANT CATHODES.
 6. FOR HDSP-7400/-7800 SERIES PRODUCT ONLY.

PIN	FUNCTION					
	A	B	C	D	E	F
1	ANODE [4]	CATHODE COLON	CATHODE [5]	ANODE COLON	ANODE [4]	CATHODE [5]
2	CATHODE f	CATHODE f	ANODE f	ANODE f	CATHODE PLUS	ANODE PLUS
3	CATHODE g	CATHODE g	ANODE g	ANODE g	CATHODE MINUS	ANODE MINUS
4	CATHODE e	CATHODE e	ANODE e	ANODE e	NC	NC
5	CATHODE d	CATHODE d	ANODE d	ANODE d	NC	NC
6	ANODE [4]	ANODE	CATHODE [5]	CATHODE	ANODE [4]	CATHODE [5]
7	CATHODE DP	CATHODE DP	ANODE DP	ANODE DP	CATHODE DP	ANODE DP
8	CATHODE c	CATHODE c	ANODE c	ANODE c	CATHODE c	ANODE c
9	CATHODE b	CATHODE b	ANODE b	ANODE b	CATHODE b	ANODE b
10	CATHODE a	CATHODE a	ANODE a	ANODE a	NC	NC

Internal Circuit Diagram

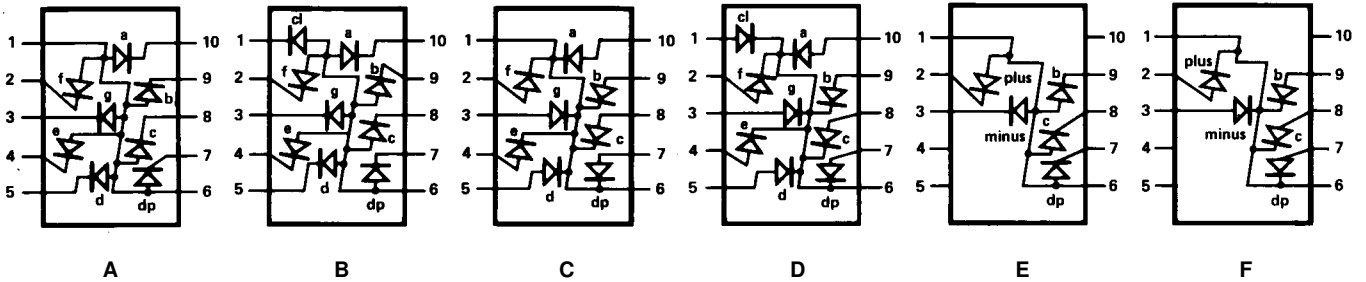

Absolute Maximum Ratings

Description	AlGaAs Red HDSP-A150 Series	HER/Orange HDSP-7500/-A40X Series	Yellow HDSP-7400 Series	Green HDSP-7800 Series	Units
Average Power per Segment or DP	96	105	80	105	mW
Peak Forward Current per Segment or DP	160 ^[1]	90 ^[3]	60 ^[5]	90 ^[7]	mA
DC Forward Current per Segment or DP	40 ^[2]	30 ^[4]	20 ^[6]	30 ^[8]	mA
Operating Temperature Range	-20 to +100 ^[9]	-40 to +100			°C
Storage Temperature Range	-55 to +100				°C
Reverse Voltage per Segment or DP	3.0				V
Wave Soldering Temperature for 3 Seconds (1.59 mm [0.063 in.] below Body)	250				°C

Notes:

- See Figure 1 to establish pulsed conditions.
- Derate above 46°C at 0.54 mA/°C.
- See Figure 6 to establish pulsed conditions.
- Derate above 53°C at 0.45 mA/°C.
- See Figure 7 to establish pulsed conditions.
- Derate above 81°C at 0.52 mA/°C.
- See Figure 8 to establish pulsed conditions.
- Derate above 39°C at 0.37 mA/°C.
- For operation below -20°C, contact your local Agilent components sales office or an authorized distributor.

Electrical/Optical Characteristics at $T_A = 25^\circ\text{C}$

AlGaAs Red

Device Series HDSP-	Parameter	Symbol	Min.	Typ.	Max.	Units	Test Conditions
A15x	Luminous Intensity/Segment ^[1,2,5] (Digit Average)	I_V	6.9	14.0		mcd	$I_F = 20\text{ mA}$
	Forward Voltage/Segment or DP	V_F		1.8		V	$I_F = 20\text{ mA}$
				2.0	3.0	V	$I_F = 100\text{ mA}$
	Peak Wavelength	λ_{PEAK}		645		nm	
	Dominant Wavelength ^[3]	λ_d		637		nm	
	Reverse Voltage/Segment or DP ^[4]	V_R	3.0	15.0		V	$I_R = 100\text{ }\mu\text{A}$
	Temperature Coefficient of V_F /Segment or DP	$\Delta V_F/^\circ\text{C}$		-2		mV/°C	
Thermal Resistance LED Junction-to-Pin	$R_{\theta J-PIN}$		255		°C/W/Seg		

High Efficiency Red

Device Series HDSP-	Parameter	Symbol	Min.	Typ.	Max.	Units	Test Conditions
750x	Luminous Intensity/Segment ^[1,2,6] (Digit Average)	I_V	360	980		μcd	$I_F = 5 \text{ mA}$
				5390			$I_F = 20 \text{ mA}$
	Forward Voltage/Segment or DP	V_F		2.0	2.5	V	$I_F = 20 \text{ mA}$
	Peak Wavelength	λ_{PEAK}		635		nm	
	Dominant Wavelength ^[3]	λ_d		626		nm	
	Reverse Voltage/Segment or DP ^[4]	V_R	3.0	30		V	$I_R = 100 \mu\text{A}$
	Temperature Coefficient of V_F /Segment or DP	$\Delta V_F / ^\circ\text{C}$		-2		mV/ $^\circ\text{C}$	
Thermal Resistance LED Junction-to-Pin	$R\theta_{\text{J-PIN}}$		200		$^\circ\text{C/W/Seg}$		

Orange

Device Series HDSP-	Parameter	Symbol	Min.	Typ.	Max.	Units	Test Conditions
A40x	Luminous Intensity/Segment ^[1,2,6] (Digit Average)	I_V		0.70		mcd	$I_F = 5 \text{ mA}$
							$I_F = 20 \text{ mA}$
	Forward Voltage/Segment or DP	V_F		2.0	2.5	V	$I_F = 20 \text{ mA}$
	Peak Wavelength	λ_{PEAK}		600		nm	
	Dominant Wavelength ^[3]	λ_d		603		nm	
	Reverse Voltage/Segment or DP ^[4]	V_R	3.0	30		V	$I_R = 100 \mu\text{A}$
	Temperature Coefficient of V_F /Segment or DP	$\Delta V_F / ^\circ\text{C}$		-2		mV/ $^\circ\text{C}$	
Thermal Resistance LED Junction-to-Pin	$R\theta_{\text{J-PIN}}$		200		$^\circ\text{C/W/Seg}$		

Yellow

Device Series HDSP-	Parameter	Symbol	Min.	Typ.	Max.	Units	Test Conditions
740x	Luminous Intensity/Segment ^[1,2,7] (Digit Average)	I_V	225	480		μcd	$I_F = 5 \text{ mA}$
				2740			$I_F = 20 \text{ mA}$
	Forward Voltage/Segment or DP	V_F		2.2	2.5	V	$I_F = 20 \text{ mA}$
	Peak Wavelength	λ_{PEAK}		583		nm	
	Dominant Wavelength ^[3,9]	λ_d	581.5	586	592.5	nm	
	Reverse Voltage/Segment or DP ^[4]	V_R	3.0	50.0		V	$I_R = 100 \mu\text{A}$
	Temperature Coefficient of V_F /Segment or DP	$\Delta V_F / ^\circ\text{C}$		-2		mV/ $^\circ\text{C}$	
Thermal Resistance LED Junction-to-Pin	$R\theta_{\text{J-PIN}}$		200		$^\circ\text{C/W/Seg}$		

High Performance Green

Device Series HDSP-	Parameter	Symbol	Min.	Typ.	Max.	Units	Test Conditions
780x	Luminous Intensity/Segment ^[1,2,8] (Digit Average)	I_V	860	3000		μcd	$I_F = 10 \text{ mA}$
				6800			$I_F = 20 \text{ mA}$
	Forward Voltage/Segment or DP	V_F		2.1	2.5	V	$I_F = 10 \text{ mA}$
	Peak Wavelength	λ_{PEAK}		566		nm	
	Dominant Wavelength ^[3,9]	λ_d		571	577	nm	
	Reverse Voltage/Segment or DP ^[4]	V_R	3.0	50.0		V	$I_R = 100 \mu\text{A}$
	Temperature Coefficient of V_F /Segment or DP	$\Delta V_F / ^\circ\text{C}$		-2		mV/ $^\circ\text{C}$	
Thermal Resistance LED Junction-to-Pin	$R\theta_{\text{J-PIN}}$		200		$^\circ\text{C/W/Seg}$		

Notes:

- Case temperature of device immediately prior to the intensity measurement is 25 $^\circ\text{C}$.
- The digits are categorized for luminous intensity. The intensity category is designated by a letter on the side of the package.
- The dominant wavelength, λ_d , is derived from the CIE chromaticity diagram and is that single wavelength which defines the color of the device.
- Typical specification for reference only. Do not exceed absolute maximum ratings.
- For low current operation the AlGaAs HDSP-A101 series displays are recommended.
- For low current operation the HER HDSP-7511 series displays are recommended.
- For low current operation the Yellow HDSP-A801 series displays are recommended.
- For low current operation the Green HDSP-A901 series displays are recommended.
- The yellow (HDSP-7400) and Green (HDSP-7800) displays are categorized for dominant wavelength. The category is designated by a number adjacent to the luminous intensity category letter.

AlGaAs Red

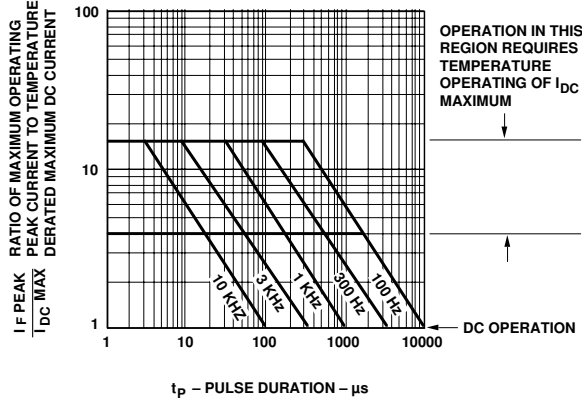

Figure 1. Maximum Allowed Peak Current vs. Pulse Duration - AlGaAs Red.

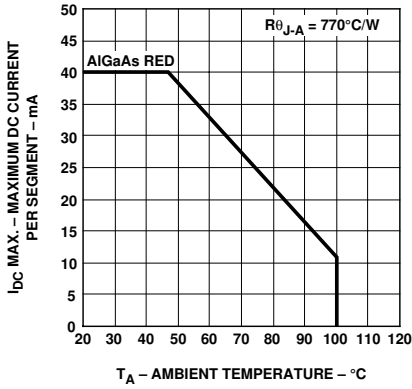

Figure 2. Maximum Allowable DC Current per Segment as a Function of Ambient Temperature.

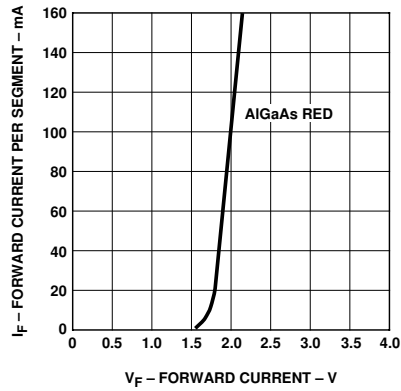

Figure 3. Forward Current vs. Forward Voltage.

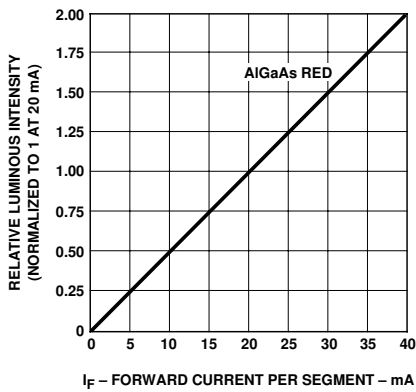

Figure 4. Relative Luminous Intensity vs. DC Forward Current.

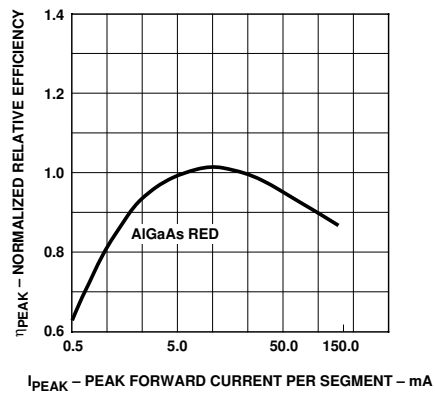

Figure 5. Relative Efficiency (Luminous Intensity per Unit Current) vs. Peak Current.

HER, Yellow, Green, Orange

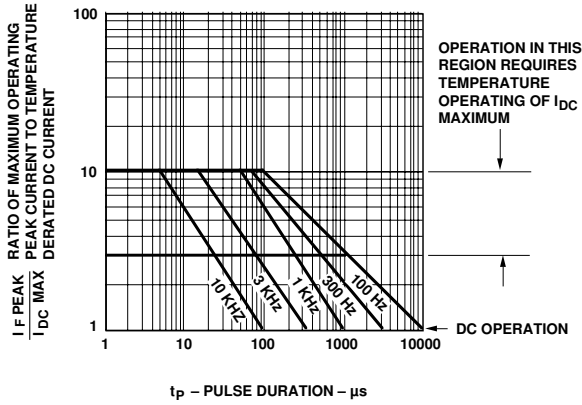

Figure 6. Maximum Tolerable Peak Current vs. Pulse Duration - HER, Orange.

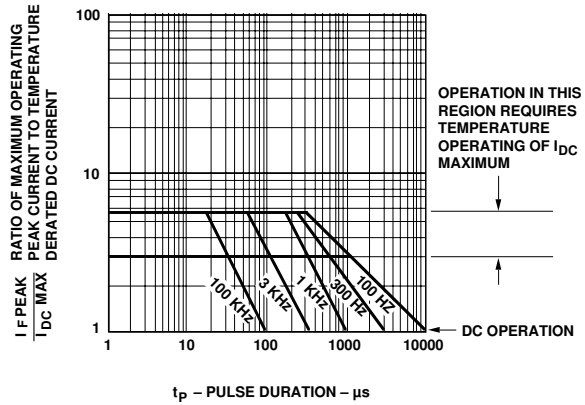

Figure 7. Maximum Tolerable Peak Current vs. Pulse Duration - Yellow.

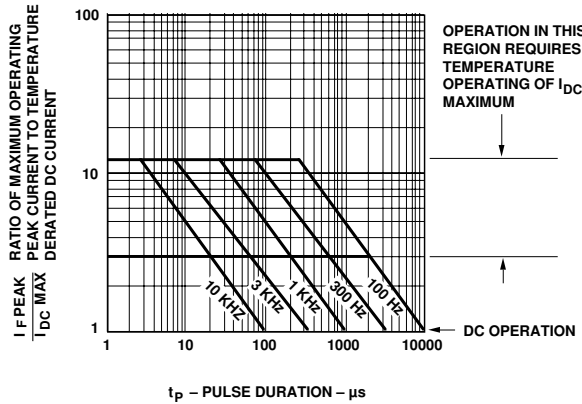

Figure 8. Allowable Peak Current vs. Pulse Duration - Green.

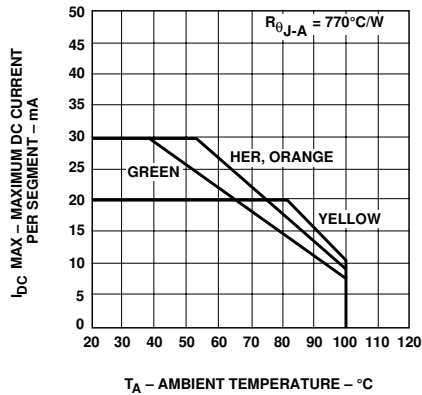

Figure 9. Maximum Allowable DC Current per Segment as a Function of Ambient Temperature.

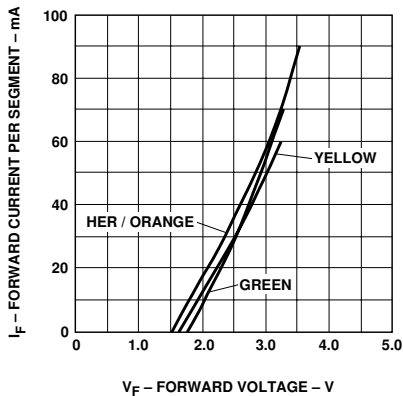

Figure 10. Forward Current vs. Forward Voltage Characteristics.

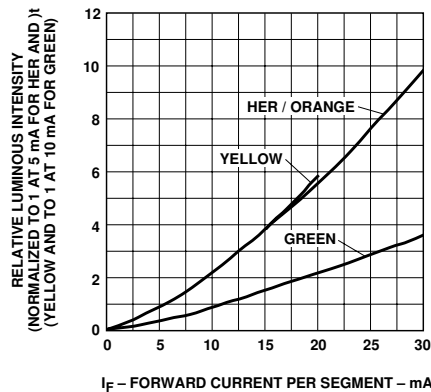

Figure 11. Relative Luminous Intensity vs. DC Forward Current.

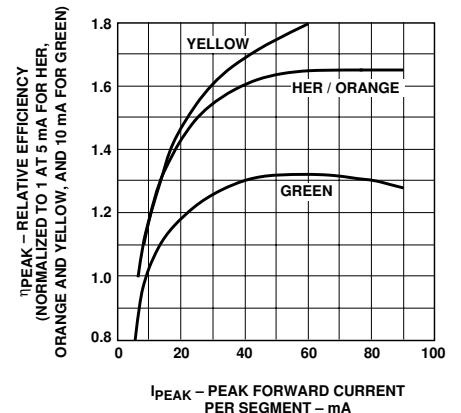

Figure 12. Relative Efficiency (Luminous Intensity per Unit Current) vs. Peak Current.

Intensity Bin Limits (mcd)**AlGaAs Red**

HDSP-A15x		
IV Bin Category	Min.	Max.
M	7.07	13.00
N	10.60	19.40
O	15.90	29.20
P	23.90	43.80
Q	35.80	65.60

HER

HDSP-750x		
IV Bin Category	Min.	Max.
B	0.342	0.630
C	0.516	0.946
D	0.774	1.418
E	1.160	2.127
F	1.740	3.190
G	2.610	4.785
H	3.915	7.177

Orange

HDSP-A40X		
IV Bin Category	Min.	Max.
A	0.284	0.433
B	0.354	0.541
C	0.443	0.677
D	0.554	0.846
E	0.692	1.057
F	0.856	1.322
G	1.082	1.652
H	1.352	2.066
I	1.692	2.581
J	2.114	3.227
K	2.641	4.034
L	3.300	5.042
M	4.127	6.303
N	5.157	7.878

Yellow

HDSP-740x		
IV Bin Category	Min.	Max.
B	0.229	0.387
C	0.317	0.582
D	0.476	0.872
E	0.714	1.311
F	1.073	1.967
G	1.609	2.950
H	2.413	4.425

Green

HDSP-780x		
IV Bin Category	Min.	Max.
H	0.86	1.58
I	1.29	2.37
J	1.94	3.55
K	2.90	5.33
L	4.37	8.01

Color Categories

Color	Bin	Dominant Wavelength (nm)	
		Min.	Max.
Yellow	1	581.50	585.00
	3	584.00	587.50
	2	586.50	590.00
	4	589.00	592.50
Green	2	573.00	577.00
	3	570.00	574.00
	4	567.00	571.00
	5	564.00	568.00

Note:

All categories are established for classification of products. Products may not be available in all categories. Please contact your Agilent representatives for further clarification/information.

Contrast Enhancement

For information on contrast enhancement, please see Application Note 1015.

Soldering/Cleaning

Cleaning agents from the ketone family (acetone, methyl ethyl ketone, etc.) and from the chlorinated hydrocarbon family (methylene chloride, trichloroethylene, carbon tetrachloride, etc.) are not recommended for cleaning LED parts. All of these various solvents attack or dissolve the encapsulating epoxies used to form the package of plastic LED parts.

For further information on soldering LEDs, please refer to Application Note 1027.

www.agilent.com/semiconductors

For product information and a complete list of distributors, please go to our web site.

For technical assistance call:

Americas/Canada: +1 (800) 235-0312 or
(916) 788-6763

Europe: +49 (0) 6441 92460

China: 10800 650 0017

Hong Kong: (+65) 6756 2394

India, Australia, New Zealand: (+65) 6755 1939

Japan: (+81 3) 3335-8152 (Domestic/International), or 0120-61-1280 (Domestic Only)

Korea: (+65) 6755 1989

Singapore, Malaysia, Vietnam, Thailand,
Philippines, Indonesia: (+65) 6755 2044

Taiwan: (+65) 6755 1843

Data subject to change.

Copyright © 2004 Agilent Technologies, Inc.

Obsoletes 5988-0382EN

July 17, 2004

5988-4434EN