

Part Number	Chip		Lens Color	V _F I _F =20mA			Reverse Current TYP.	Peak Forward Current MAX.	Power Dissipation TYP.	I _v (mcd) I _F =20mA			View Angle
	Emitted Color	λ P (nm)		MIX	TYP	MAX				MIX	TYP	MAX	
5AR2PD	● RED	680	D.	2.0	2.2	2.5	10uA	200mA	100mW	8	12	70
5AR2HD	● RED	640	D.	1.7	1.9	2.3	10uA	200mA	100mW	60	80	70
5AR2SD	● RED	640	D.	1.7	1.9	2.3	10uA	200mA	100mW	300	70
5AR2UD	● RED	640	D.	1.7	1.9	2.3	10uA	200mA	100mW	600	70
5AYG2HD	● YELLOW GREEN	570	D.	2.0	2.3	2.5	10uA	200mA	100mW	60	80	70
5AY2HD	● YELLOW	590	D.	2.0	2.1	2.5	10uA	200mA	100mW	50	80	70
5AO2HD	● ORANGE	680	D.	2.0	2.2	2.5	10uA	200mA	100mW	80	150	70
5AR2PT	● RED	600	T.	1.9	2.1	2.4	10uA	200mA	100mW	200	350	70
5AR2HT	● RED	640	T.	1.7	1.9	2.3	10uA	200mA	100mW	70	100	30
5AYG2HT	● YELLOW GREEN	570	T.	2.0	2.3	2.5	10uA	200mA	100mW	200	250	30
5AY2HT	● YELLOW	590	T.	2.0	2.1	2.5	10uA	200mA	100mW	250	350	30
5AO2HT	● ORANGE	600	T.	1.9	2.1	2.4	10uA	200mA	100mW	300	700	30
5AP2HC	● PURPLE	400	W.C.	3.0	3.5	3.8	10uA	200mA	100mW	150	300	30
5AR2SC	● RED	640	W.C.	1.7	1.9	2.3	10uA	200mA	100mW	800	1000	20
5AYG2SC	● YELLOW GREEN	570	W.C.	2.0	2.3	2.5	10uA	200mA	100mW	200	300	
5AY2SC	● YELLOW	590	W.C.	2.0	2.1	2.5	10uA	200mA	100mW	2000	2500	
5AO2SC	● ORANGE	600	W.C.	1.9	2.1	2.4	10uA	200mA	100mW	1000	2000	
5AW2SC	● WHITE	W.C.	2.8	3.2	3.6	10uA	200mA	100mW	2000	3000	
5AB2SC	● BLUE	470	W.C.	2.8	3.2	3.6	10uA	200mA	100mW	1500	2000	
5AP2SC	● PURPLE	410	W.C.	3.0	3.5	3.8	10uA	200mA	100mW	1000	1500	
5AR2UC	● RED	625	W.C.	1.7	1.9	2.3	10uA	200mA	100mW	2000	3000	20
5APG2UC	● GREEN	525	W.C.	2.8	3.2	3.6	10uA	200mA	100mW	5000	7000	
5AW2UC	● WHITE	W.C.	2.8	3.2	3.6	10uA	200mA	100mW	4000	5000	
5AY2UC	● YELLOW	590	W.C.	2.0	2.1	2.5	10uA	200mA	100mW	3000	4000	
5AB2UC	● BLUE	470	W.C.	2.8	3.2	3.6	10uA	200mA	100mW	2000	3000	
5AO2UC	● ORANGE	600	W.C.	1.9	2.1	2.4	10uA	200mA	100mW	2000	2500	

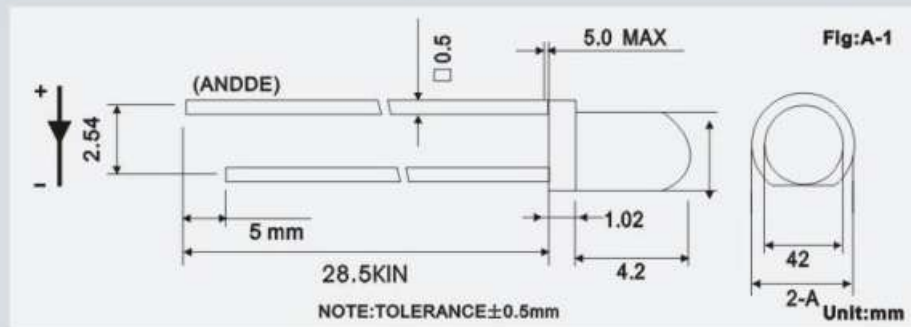

Part Number	Chip		Lens Color	V _F I _F =20mA			Reverse Current TYP.	Peak Forward Current MAX.	Power Dissipation TYP.	I _v (mcd) I _F =20mA			View Angle
	Emitted Color	λ P (nm)		MIX	TYP	MAX				MIX	TYP	MAX	
5AR4PD	● RED	680	D.	2.0	2.2	2.5	10uA	200mA	100mW	8	12	70
5AR4HD	● RED	640	D.	1.7	1.9	2.3	10uA	200mA	100mW	60	80	70
5AR4SD	● RED	640	D.	1.7	1.9	2.3	10uA	200mA	100mW	300	70
5AR4UD	● RED	640	D.	1.7	1.9	2.3	10uA	200mA	100mW	600	70
5AYG4HD	● YELLOW GREEN	570	D.	2.0	2.3	2.5	10uA	200mA	100mW	60	80	70
5AY4HD	● YELLOW	590	D.	2.0	2.1	2.5	10uA	200mA	100mW	50	80	70
5AO4HD	● ORANGE	680	D.	2.0	2.2	2.5	10uA	200mA	100mW	80	150	70
5AR4PT	● RED	600	T.	1.9	2.1	2.4	10uA	200mA	100mW	70	100	70
5AR4HT	● RED	640	T.	1.7	1.9	2.3	10uA	200mA	100mW	200	350	30
5AYG4HT	● YELLOW GREEN	570	T.	2.0	2.3	2.5	10uA	200mA	100mW	200	250	30
5AY4HT	● YELLOW	590	T.	2.0	2.1	2.5	10uA	200mA	100mW	250	350	30
5AO4HT	● ORANGE	600	T.	1.9	2.1	2.4	10uA	200mA	100mW	300	700	30
5AP4HC	● PURPLE	400	W.C.	3.0	3.5	3.8	10uA	200mA	100mW	150	300	30
5AR4SC	● RED	640	W.C.	1.7	1.9	2.3	10uA	200mA	100mW	800	1000	20
5AYG4SC	● YELLOW GREEN	570	W.C.	2.0	2.3	2.5	10uA	200mA	100mW	200	300	
5AY4SC	● YELLOW	590	W.C.	2.0	2.1	2.5	10uA	200mA	100mW	2000	2500	
5AO4SC	● ORANGE	600	W.C.	1.9	2.1	2.4	10uA	200mA	100mW	1000	2000	
5AW4SC	● WHITE	W.C.	2.8	3.2	3.6	10uA	200mA	100mW	2000	3000	
5AB4SC	● BLUE	470	W.C.	2.8	3.2	3.6	10uA	200mA	100mW	1500	2000	
5AP4SC	● PURPLE	410	W.C.	3.0	3.5	3.8	10uA	200mA	100mW	1000	1500	
5AR4UC	● RED	625	W.C.	1.7	1.9	2.3	10uA	200mA	100mW	2000	3000	
5APG4UC	● GREEN	525	W.C.	2.8	3.2	3.6	10uA	200mA	100mW	5000	7000	
5AW4UC	● WHITE	W.C.	2.8	3.2	3.6	10uA	200mA	100mW	4000	5000	
5AY4UC	● YELLOW	590	W.C.	2.0	2.1	2.5	10uA	200mA	100mW	3000	4000	20
5AB4UC	● BLUE	470	W.C.	2.8	3.2	3.6	10uA	200mA	100mW	2000	3000	
5AO4UC	● ORANGE	600	W.C.	1.9	2.1	2.4	10uA	200mA	100mW	2000	2500	

PACKAGE DIMENSIONS

NOTE:TOLERANCE±0.5mm UNIT:mm

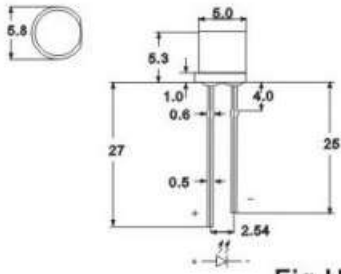

Fig.H

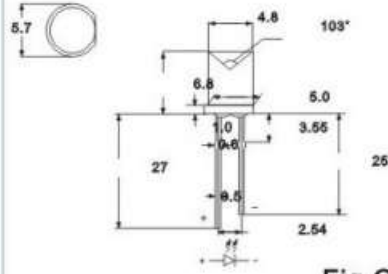

Fig.G

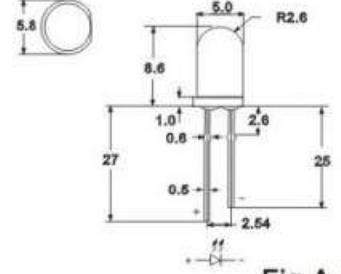

Fig.A-8

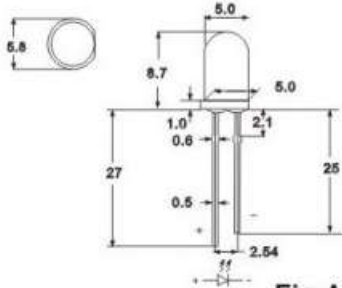

Fig.A-9

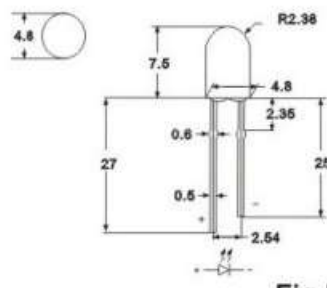

Fig.B-4

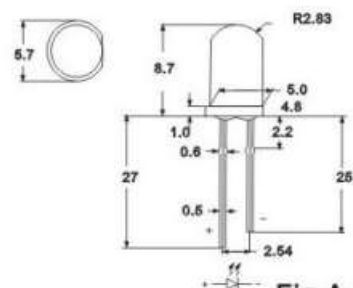

Fig.A-10

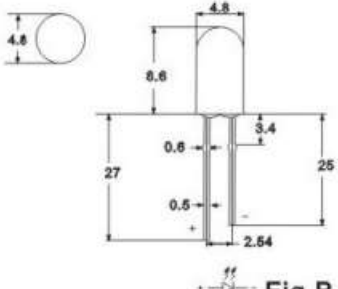

Fig.B-5

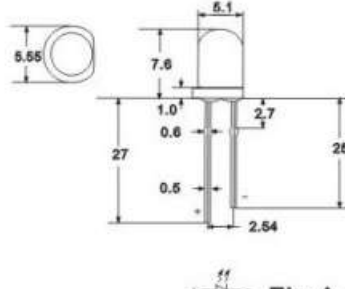

Fig.A-11

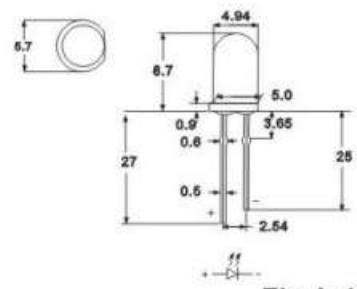

Fig.A-12

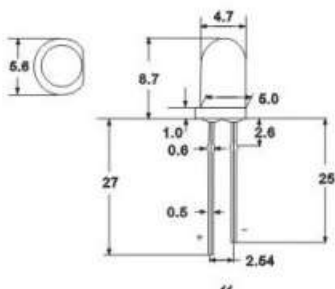

Fig.A-13

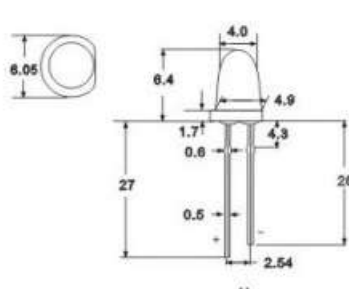

Fig.D-1

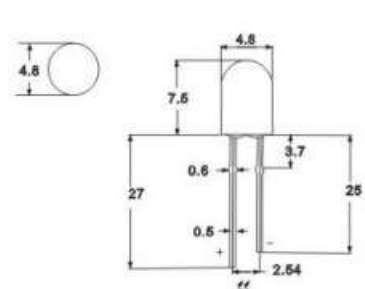

Fig.B-6