

FILTERS

FOR AM APPLICATIONS 450–470kHz

SFU/SFZ SERIES

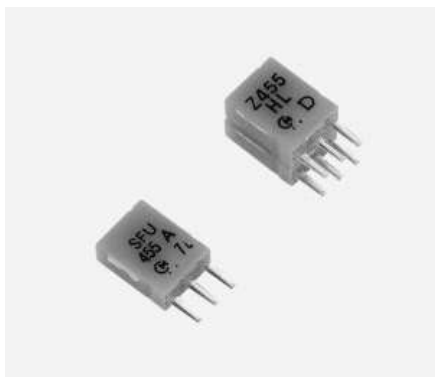

FEATURES

- Center frequency range between 450 and 470kHz is available. Standard tolerance is ± 2 kHz.
- For synthesizers, the types of center frequencies 450, 459 and 468kHz are available. Standard tolerance is ± 1 kHz.
- The part numbers of the types for synthesizers are as follows:
(In case of 450kHz)
SFU450A3 (for contact to resistor)
SFU450C5 (for contact to resistor)

SFU450B14 (for contact to IFT)
SFZ450HL3/JL3/KL3
SFZ450H3/J3/K3 (for contact to resistor)

DIMENSIONS: mm

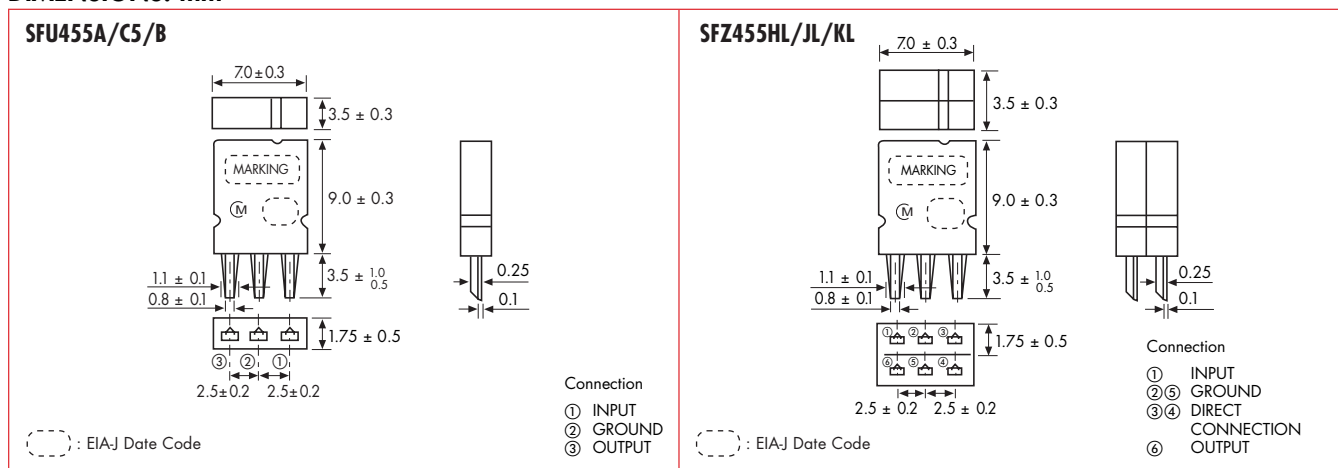

SPECIFICATIONS

SFU 455kHz

Part Number	3dB Band Width (kHz)	Selectivity		Insertion Loss (dB) max.	Composition
		+9kHz off (dB) min.	-9kHz off (dB) min.		
SFU455A	10 \pm 3	3 (5.5)	5 (7.5)	5 (3)	1 Element for contact to resistor
SFU455C5	5 \pm 1.5	7 (10)	10 (13.5)	6 (3.8)	1 Element for contact to resistor
SFU455B	10 \pm 3	3 (5.5)	5 (7.5)	5 (3)	1 Element for contact to IFT
SFZ455HL	4 \pm 1	23 (28)		7 (4.5)	2 Elements
SFZ455JL	5.5 \pm 1	18 (22)		7 (3.5)	2 Elements
SFZ455KL	7 \pm 1	16 (20)		6 (2.7)	2 Elements

() Typical value

PART NUMBERING SYSTEM

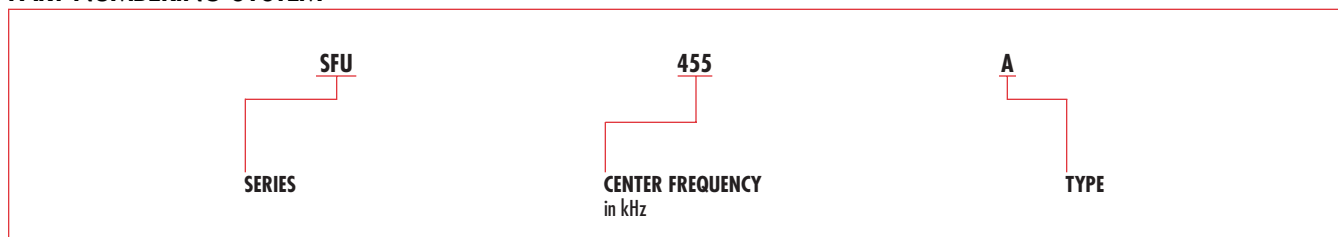

*Applicable in North American market only. ▼Applicable in European market only.
 For more detailed information regarding this product line in North America, see Catalog No. P-05-D. To receive additional information on Murata Products call 1-800-831-9172.
 For more detailed information regarding this product line in Europe, see Catalog No. P05E-8 and P10E-2.

FILTERS

FOR AM APPLICATIONS—SIGNAL DETECTION

BFU/SFZ SERIES

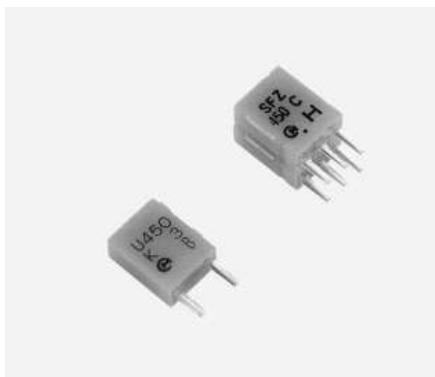

FEATURES

- $f_a - f_r$: Difference between the anti-resonant frequency and the resonant frequency
- Most suitable for IC Station Detectors (SD) such as the LA 1135 (by Sanyo)

DIMENSIONS: mm

BFU Series	SFZ Series▼
□: EIA-J Date Code NO DIRECTIVITY	□: EIA-J Date Code Connection: ① INPUT ②⑤ GROUND ③④ DIRECT CONNECTION ⑥ OUTPUT

SPECIFICATIONS

Part Number	Resonant Frequency (kHz)	$f_a - f_r$ (kHz)	Resonant Resistance (Ω) max.	Capacitance (pF)
BFU450K3	450 ± 1	27.5 ± 4.5	30 (10)	550 ± 20%
BFU450C	450 ± 1	14 ± 2	20 (10)	360 ± 20%
BFU450C4N	450 ± 0.8	9 ± 2	30 (12)	360 ± 20%
Part Number	Center Frequency (kHz)	3dB Bandwidth (kHz)	Selectivity	Application
SFZ450C3N	450 ± 1	2.5 ± 1	$f_0 - 9\text{kHz}$ (30dB) $f_0 + 9\text{kHz}$ (24dB)	IF Signal Detection

() Typical value

PART NUMBERING SYSTEM

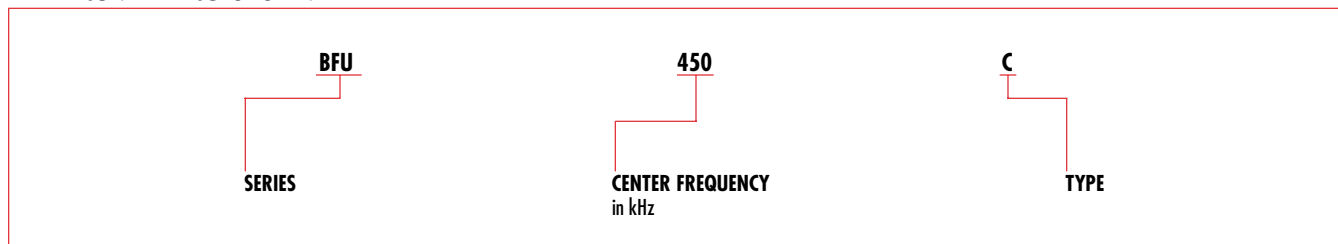

▲Applicable in North American market only. ▼Applicable in European market only.
 For more detailed information regarding this product line in North America, see Catalog No. P-05-D. To receive additional information on Murata Products call 1-800-831-9172.
 For more detailed information regarding this product line in Europe, see Catalog No. P10E-2.

FILTERS

FILTERS

FOR AM APPLICATIONS, MINIATURE

PFS/PFB/PFWCC SERIES ▼

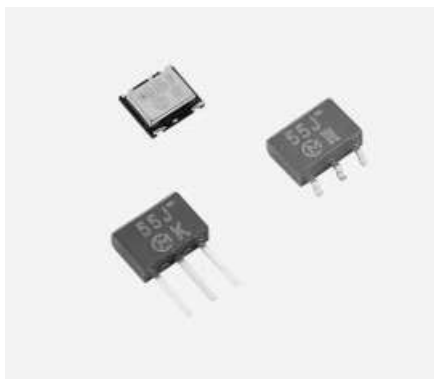

FEATURES

- Center frequency is available between 450 and 470kHz. Standard tolerance is ± 2 kHz.
- For synthesizers, the types of center frequencies 450, 459 and 468kHz are available. Standard tolerance is ± 1 kHz.
- PFWCC Series is mountable by automatic placers. ("TC" is added to the part number for tape and reel. ex. PFWCC450JR-TC)

DIMENSIONS: mm

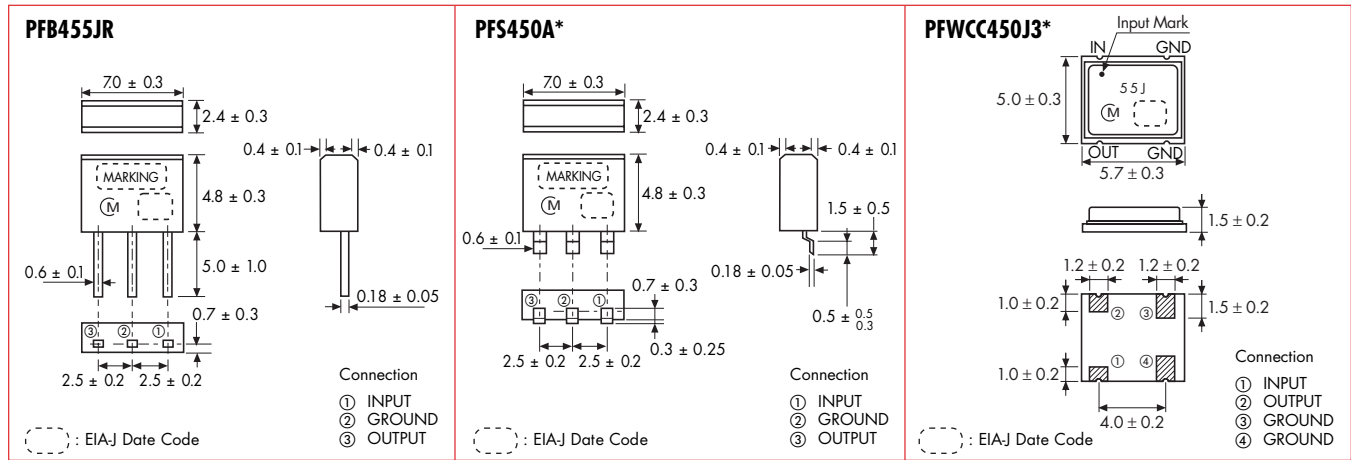

*Available on tape

SPECIFICATIONS

Part Number	3dB Band Width (kHz)	Selectivity	Insertion Loss (dB) max.	Composition
		+9kHz off (dB) min.		
PFB455JR ▼	5.5 ± 1.5	17 (23)	6 (3)	2 Elements
PFS450A ▼	4.5 ± 1.5	8	5	1 Element, Leaded
PFWCC450J3 ▼	5.5 ± 1.5	17 (23)	6 (3)	2 Elements, SMD

() Typical value

PART NUMBERING SYSTEM

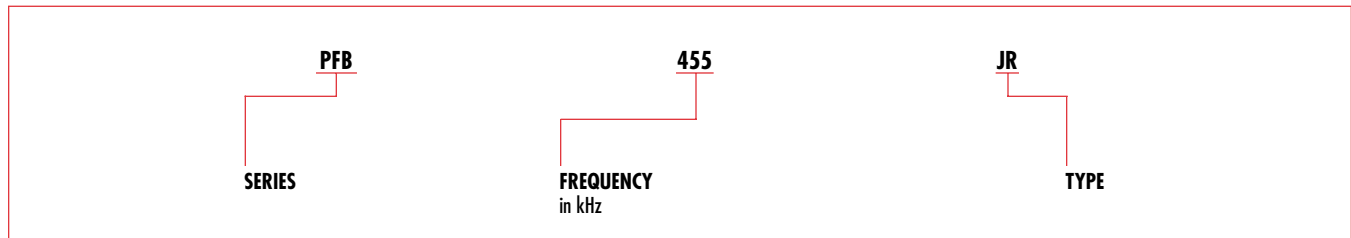

▲Applicable in North American market only. ▼Applicable in European market only.

For more detailed information regarding this product line in North America, see Catalog No. P-05-D. To receive additional information on Murata Products call 1-800-831-9172.

For more detailed information regarding this product line in Europe, see Catalog No. P10E-2.

FILTERS FOR AM APPLICATIONS—HIGHLY SELECTIVE CFWS/SFPS SERIES

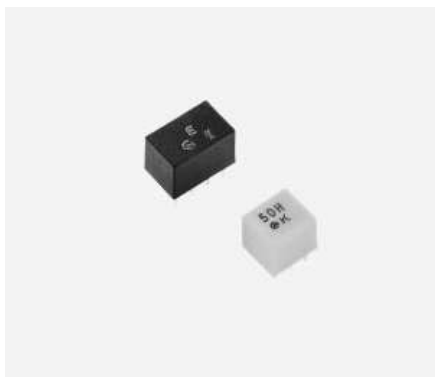

For synthesizers, the available center frequencies are 450, 459 and 468kHz. Standard tolerance is ± 1 kHz. Because of excellent shape factor, wide-band width and high selectivity, this series is the most suitable to car radios and all-band radios.

- Operating temperature range: -20°C to $+80^{\circ}\text{C}$
- Storage temperature range: -40°C to $+85^{\circ}\text{C}$

FEATURES

- Low profile, high selectivity
- Easily mountable on any PC board.

DIMENSIONS: mm

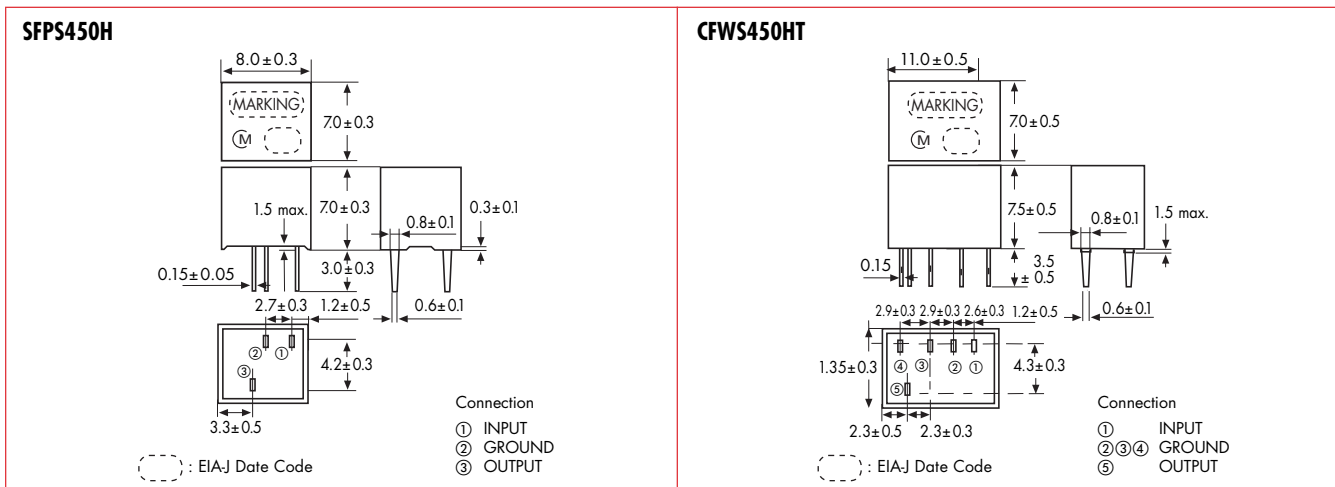

SPECIFICATIONS

CFWS450 kHz/SFPS450kHz

Part Number	6dB Bandwidth (kHz) min.	Selectivity	Insertion Loss (dB) max.	Matching Impedance (k Ω)	Composition
		± 9 kHz off (dB) min.			
SFPS450H	± 3.0 (± 4.0)	40 (60)	6 (1.5)	2.0	4 Elements Ladder Type
CFWS450HT	± 3.0 (± 4.0)	50 (75)	6 (2.0)	2.0	6 Elements Ladder Type

() Typical value

PART NUMBERING SYSTEM

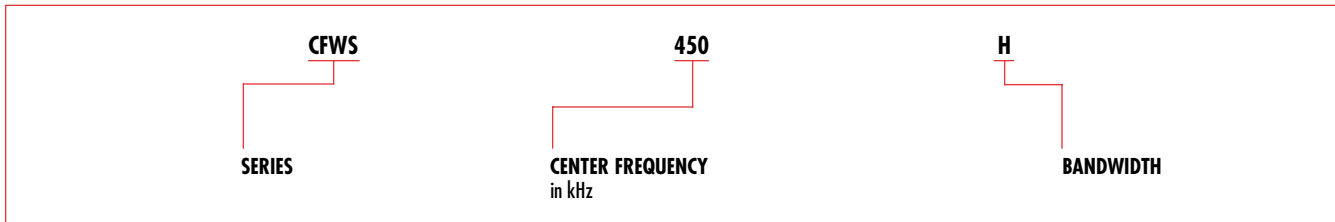

* Available as standard through authorized Murata Electronics Distributors. *Applicable in North American market only. ▼Applicable in European market only. For more detailed information regarding this product line in North America, see Catalog No. P-05-D. To receive additional information on Murata Products call 1-800-831-9172. For more detailed information regarding this product line in Europe, see Catalog No. P10E-2.

FILTERS

FILTERS FOR AM APPLICATIONS SFGCG, SFPC, CFUCG 455kHz

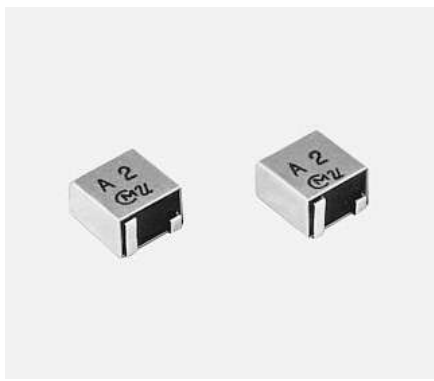

Along with the development of the AM chip filter, IF filters for AM/FM radios have also been made smaller, thinner and in a chip configuration for surface mounting. This is one more example of Murata Electronics' leadership in converting conventional electronic components to chip technology.

FEATURES

- The filters are mountable by automatic placers.
- The filters can be reflow soldered and withstand washing.

- They are slim, at only 4.0mm maximum thickness, and have a small mounting area enabling flexible PCB design. (5.0mm maximum thickness for SFPC).
- The bandwidth ranges from 35kHz to 6kHz.
- Operating temperature range: -20°C to +80°C
Storage temperature range: -40°C to +85°C
- For reflow soldering
- Also available in 450kHz center frequency

DIMENSIONS: mm

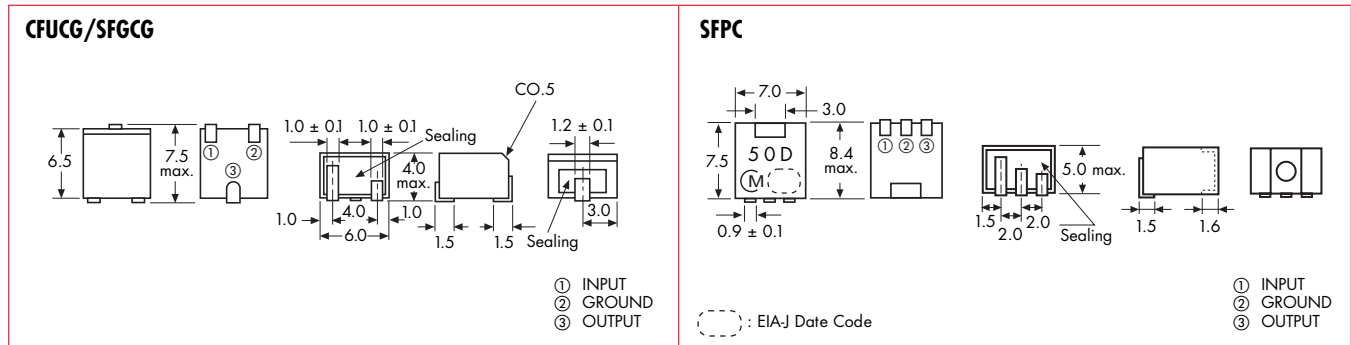

SPECIFICATIONS

CFUCG/SFGCG/SFPC SERIES

Part Number	Center Frequency		Bandwidth (Total)			Ripple (max.)		*Insertion Loss (max.) dB	Stop Band Atten. (min.) at ± 100kHz dB	Group Delay (max.)		Source and Load Impedance (Ω)
	Nom. (kHz)	Tol. ± (kHz)	3dB (min.) (kHz)	6dB (min.) (kHz)	40dB (max.) (kHz)	dB	Point of Measure			μS	Point of Measure	
CFUCG455D-TC	455	1.5	—	10	20	2.0	±7	4	27	—	—	1500
CFUCG455E-TC	455	1.5	—	15	30	1.5	±5	6	27	—	—	1500
CFUCG455F-TC	455	1.5	—	12	25	1.5	±4	6	27	—	—	1500
CFUCG455G-TC	455	1	—	9	20	1.5	±3	6	25	—	—	1500
CFUCG455FX-TC	455	1.5	—	12	30	1	±4	6	27	25	±4	1500
CFUCG455GX-TC	455	1	—	9	25	1	±3	6	25	25	±3	1500
CFUCG455HX-TC	455	1	—	6	20	1	±2	7	25	25	±2	1500
SFGCG455AX2-TC▲	455	—	28	—	70	1	±10	5	25	15	±10	1000
SFGCG455BX-TC	455	1.5	—	30	70	1	±10	5	25	15	±10	1000
SFGCG455CX-TC	455	1.5	—	25	60	1	±8	6	25	15	±8	1000
SFGCG455DX-TC	455	1	—	20	50	1	±7	7	23	20	±7	1500
SFGCG455EX-TC	455	1	—	15	40	1	±5	8	23	20	±5	1500
SFPC455E-TC	455	1.5	—	15	30	1.5	±5	6	27	—	—	1500
SFPC455F-TC	455	1.5	—	12	25	1.5	±4	6	27	—	—	1500
SFPC455G-TC	455	1	—	9	20	1.5	±3	6	25	—	—	1500
SFPC455H-TC	455	1	—	6	—	1.5	±2	6	35	—	—	2000
SFGCG455AX-TC	455	2	—	35	80	1	±10	4	25	15	±10	1000

*Note: For safety purposes, connect the output of filters to the IF amplifier through a DC blocking capacitor. Avoid applying a direct current to the output of ceramic filters.

PART NUMBERING SYSTEM

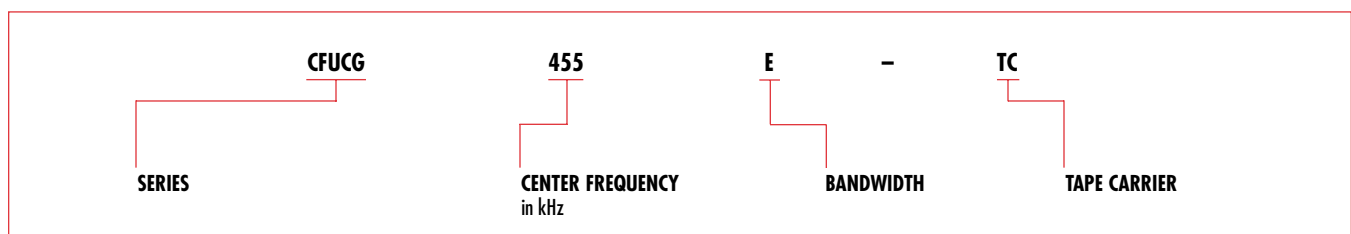

▲Applicable in North American market only. ▼Applicable in European market only.

For more detailed information regarding this product line in North America, see Catalog No. P-05-D. To receive additional information on Murata Products call 1-800-831-9172.

For more detailed information regarding this product line in Europe, see Catalog No. PO5E-8.

FILTERS

FOR FM APPLICATIONS—LOW LOSS, HIGHLY SELECTIVE, MINIATURE—SFE MA/MS/MJ/MH 10.7MHz

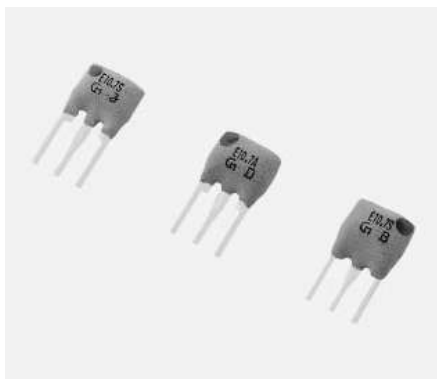

The standard SFE 10.7 line of ceramic filters are extremely reliable devices that exhibit excellent waveform symmetry. These filters have traditionally found wide application in FM receiver technology.

FEATURES

- These miniature filters have high mechanical strength.
- Low loss, favorable waveform symmetry, and high selectivity
- Various band widths are available for

- applications in wide to narrow bands.
- Small dispersion and stable characteristics.
- Change in center frequency is typically within $\pm 30\text{ppm}/^\circ\text{C}$ at $-20 \sim +80^\circ\text{C}$.
- High reliability

DIMENSIONS: mm

STANDARD SERIES	A10 SERIES Low Loss	C10 SERIES Low Profile	TEST CIRCUIT
			<p> $R_g + R_1 = R_2 = 330\Omega \pm 5\%$ $C = 10\text{pF}$ (including stray capacitance and input capacitance of RF Voltmeter) </p> <p> ① INPUT ② GROUND ③ OUTPUT </p>

SPECIFICATIONS

SFE A10/B10/C10 SERIES

	Part Number	3dB Bandwidth (kHz)	20dB Bandwidth (kHz) max.	Ripple (dB) max.	Insertion Loss (dB) max.	Spurious (9~12MHz) (dB) min.
FM-IF	SFE10.7MA5-A	280 ± 50	650 (520)	1	6 (4)	30 (43)
	SFE10.7MS2-A	230 ± 50	600 (420)	1	6 (4)	40 (45)
	SFE10.7MS3-A	180 ± 40	520 (380)	1	7 (4.5)	40 (45)
• Input/output impedance: 330Ω () Typical value						
A10 Series	SFE10.7MA5A10-A	280 ± 50	590 (480)	1	2.5 ± 2.0	30 (42)
	SFE10.7MS2A10-A	230 ± 40	520 (410)	1	3.0 ± 2.0	35 (42)
	SFE10.7MS3A10-A	180 ± 40	470 (370)	1	3.5 ± 1.5	35 (42)
	SFE10.7MJA10-A	150 ± 40	360 (300)	1	4.5 ± 2.0	35 (42)
• Input/output impedance: 330Ω • Low loss and high selectivity. () Typical value						
B10 Series	SFE10.7MA5B10-A	280 ± 50	650	1	3.0 ± 2.0	45
	SFE10.7MS2B10-A	230 ± 50	570	1	3.0 ± 2.0	45
	SFE10.7MS3B10-A	180 ± 40	520	1	5.0 ± 2.0	45
• Input/output impedance: 330Ω • High attenuation type						
C10 Series	SFE10.7MA5C10-A	280 ± 50	650 (540)	1	3.0 ± 2.0	30 (47)
	SFE10.7MS2C10-A	230 ± 50	570 (470)	1	3.0 ± 2.0	40 (49)
	SFE10.7MS3C10-A	180 ± 40	470 (360)	1	3.5 ± 2.0	35 (47)
	SFE10.7MJC10-A	150 ± 40	360 (300)	1	4.5 ± 2.0	35 (42)
	SFE10.7MHC10-A	110 ± 30	350 (260)	1	7.0 ± 2.0	30 (38)
• Input/output impedance: 330Ω • Most suitable for a thin type and low profile set. • The performance is the same as that of conventional types. () Typical value						

PART NUMBERING SYSTEM



*Applicable in North American market only. *Applicable in European market only.
 For more detailed information regarding this product line in North America, see Catalog No. P-05-D. To receive additional information on Murata Products call 1-800-831-9172.
 For more detailed information regarding this product line in Europe, see Catalog No. P61E-4.

FILTERS

FILTERS

FOR FM APPLICATIONS—HIGHLY SELECTIVE G.D.T. FLAT TYPE SFE MX/MA8/ML 10.7MHz



Innovator in Electronics

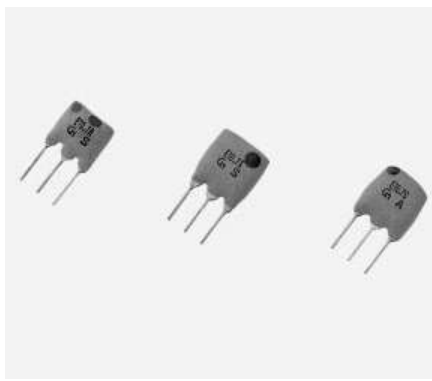

The SFE 10.7MX/MA8/ML lines of ceramic filters were designed to minimize the dispersion of amplitude and phase characteristics within the pass band. Because the excellent G.D.T. characteristics of these filters insure signal integrity, they are recommended for use in applications ranging from high grade stereo receivers to digital transmission systems.

FEATURES

- Little dispersion of amplitude characteristics and phase characteristics (G.D.T. characteristics)
- The SFE 10.7 MX Series has G.D.T. characteristics and is useful for obtaining

low distortion. SFE 10.7 ML Series, in these ceramic filters, being in harmony with flatness of G.D.T., roundness of the amplitude and selectivity characteristics, therefore, these ceramic filters are suitable to high-grade stereo tuners. Even if mismatching condition, they can keep little distortion because of low Qm of ceramic material. The SFE 10.7 MA8 Series is based on SFE 10.7 MA5/MS2/MS3, and it obtains high selectivity with low loss. There is little dispersion of amplitude and G.D.T. characteristics, and low distortion rate can be obtained.

- All products are inspected for symmetry and roundness of amplitude

DIMENSIONS

MX SERIES Low Distortion	MA8 SERIES High Selectivity, Low Loss	ML SERIES Selectivity	TEST CIRCUIT
<p>① : EIAJ Date Code</p>	<p>① : EIAJ Date Code</p>	<p>① : EIAJ Date Code</p>	<p> $R_1 + R_g = R_2 = 330\Omega$ $C = 10\text{pF}$ (including stray capacitance and input capacitance of RF Voltmeter) </p> <p> ① INPUT ② GROUND ③ OUTPUT </p>

SPECIFICATIONS

SFE MX/MA8/ML SERIES

	Part Number	3dB Bandwidth (kHz)	20dB Bandwidth (kHz) max.	Insertion Loss (dB) max.	Spurious (9~12MHz) (dB) min.	Ripple w/n 3dB Bandwidth (dB)	G.D.T. Bandwidth (kHz) min.
MX Series	SFE10.7MX-A	250 ± 40	670 (620)	12 (10)	25 (33)	0 max.	0.2μ sec. fo ±110kHz
	SFE10.7MX2-A	220 ± 40	610 (560)	12.5 (10.5)	30 (37)	0 max.	0.15μ sec. fo ±80kHz
	SFE10.7MZ1-A	180 ± 30	530 (460)	14 (12.3)	33 (38)	0 max.	0.15μ sec. fo ±60kHz
	SFE10.7MZ2-A	150 ± 30	500 (420)	14 (12.6)	35 (41)	0 max.	0.15μ sec. fo ±50kHz
MA8 Series	SFE10.7MA8-A	280 ± 50	650 (520)	6 (4)	30 (43)	0.5 max.	0.5μ sec. fo ±80 (±100)
	SFE10.7MS2G-A	230 ± 50	600 (420)	7 (4.5)	40 (45)	0 max.	0.5μ sec. fo ±60 (±75)
	SFE10.7MS3G-A	180 ± 40	520 (380)	7 (5)	40 (45)	0 max.	0.5μ sec. fo ±45 (±60)
ML Series	SFE10.7ML-A	280 ± 50	700 (610)	9 (7)	25 (33)	0 max.	0.25μ sec. fo ±70 (±105)
	SFE10.7MP3-A	250 ± 50	650 (550)	10 (8)	30 (35)	1.0 max.	0.25μ sec. fo ±65 (±90)
	SFE10.7MM-A	230 ± 50	600 (510)	11 (9)	30 (38)	0 max.	0.25μ sec. fo ±60 (±85)

- Input/output impedance: 330Ω
- The rank of center frequency is available in two series: 30kHz steps and 25kHz steps.
- The G.D.T. waveforms of all these types are controlled.

() Typical value

PART NUMBERING SYSTEM



*Applicable in North American market only. *Applicable in European market only.
 For more detailed information regarding this product line in North America, see Catalog No. P-05-D. To receive additional information on Murata Products call 1-800-831-9172.
 For more detailed information regarding this product line in Europe, see Catalog No. P61E-4.

FILTERS

FOR FM APPLICATIONS—HIGHLY SELECTIVE, 3 ELEMENTS SFT MA/MS 10.7MHz

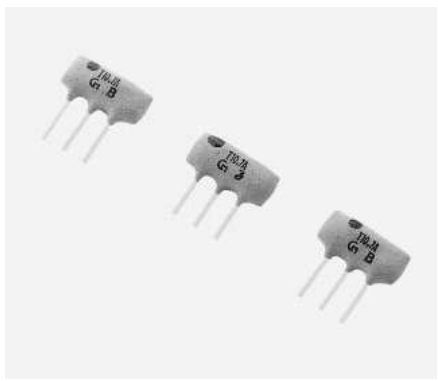
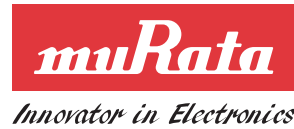

The SFT 10.7 ceramic filters are single substrate, 3 element devices that offer 1.5 times more selectivity than the conventional SFE Series of filters. The improved spurious suppression of these filters eliminates the need for cascading multiple filtering devices; therefore, it is possible to design a more compact circuit board configuration.

FEATURES

- It has an excellent shape factor, and it is possible to obtain 1.5 times more

- excellent selectivity than SFE 10.7 Series (by detuning ± 300 or 400kHz).
- Good performance of spurious suppression.
- Having the same terminal pitch as the SFE 10.7 Series, it easily replaces that series.
- By replacing two SFE 10.7 Series filters with one SFT 10.7 filter, more compact sets can be made.
- Well-suited for 1-chip ICs.

DIMENSIONS: mm

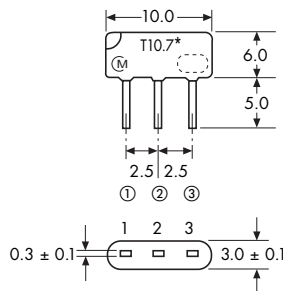

○: EIA-J Date Code

*Varies by part number

TEST CIRCUIT

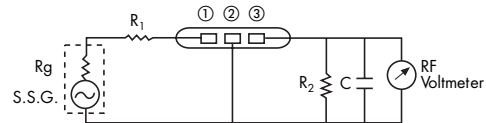

$R_g + R_1 = 330\Omega$
 $C = 10\text{pF}$
 (including stray capacitance and input capacitance of RF Voltmeter.)

- ① INPUT
- ② GROUND
- ③ OUTPUT

SPECIFICATIONS

SFT MA/MS 10.7MHz

Part Number	3dB Bandwidth (kHz)	40dB Bandwidth (kHz) max.	Ripple within 3dB Bandwidth (dB)	Insertion Loss (dB) max.	Spurious Attenuation (9 ~ 12MHz) (dB) min.
SFT10.7MA5	280 ± 50	700 (630)	0.5 max.	6 ± 2	50 (60)
SFT10.7MS2	230 ± 40	650 (580)	0.5 max.	6 ± 2	50 (60)
SFT10.7MS3	180 ± 40	550 (500)	0.5 max.	8 ± 2	50 (60)

- Input/output impedance: 330Ω
- High selectivity is achieved by replacing with SFT 10.7 Series

() Typical value

PART NUMBERING SYSTEM

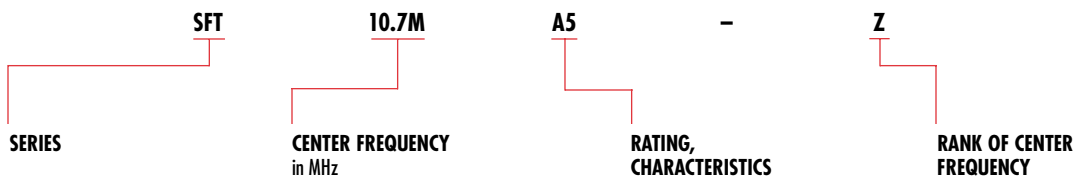

▲Applicable in North American market only. ▼Applicable in European market only.

For more detailed information regarding this product line in North America, see Catalog No. E-06-E. To receive additional information on Murata Products call 1-800-831-9172. For more detailed information regarding this product line in Europe, see Catalog No. P61E-4.

DISCRIMINATORS FOR FM APPLICATIONS CDA 10.7MHz

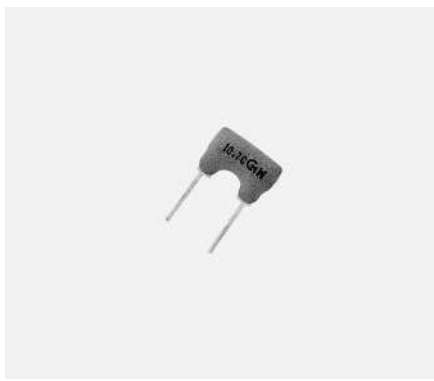

The CDA MC/MG lines of ceramic discriminators are IC dependent devices used in the recovery of audio signals. The CDA MC discriminators have three terminals while the MG discriminators are 2 terminal devices.

FEATURES

- Compact and excellent mechanical strength
- Can be combined with various ICs. The IC is determined by the last number in the part number.

- Stable demodulation characteristics can be obtained without adjustment.
- The MG type for wide bandwidths and the MC type for narrow bandwidths are available.
- Stable temperature characteristics
- We recommend kits: ceramic discriminator CDA10.7 Series and Cerafil® SFE10.7 of the same frequency rank.

DIMENSIONS: mm

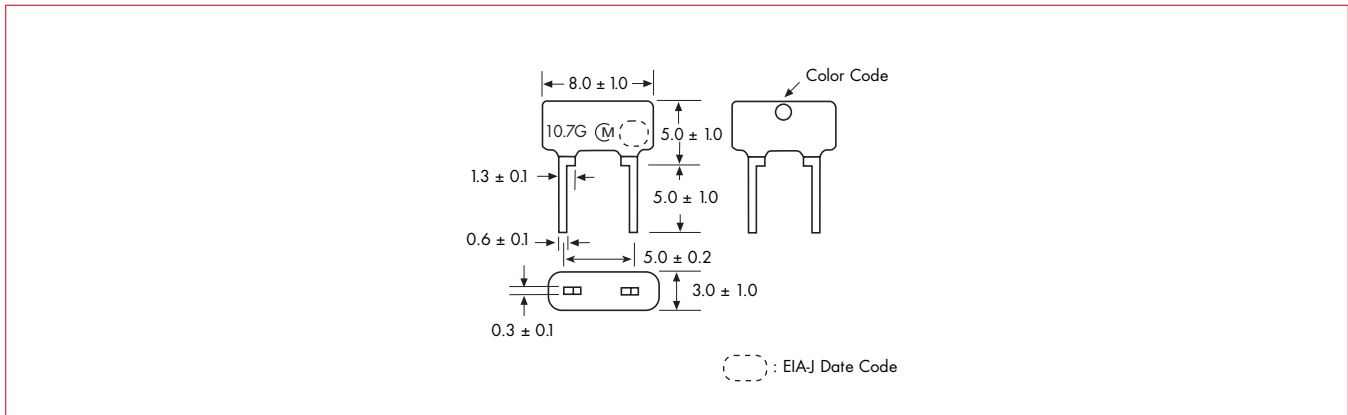

DISCRIMINATORS

CDA10.7

Part Number	Demodulation Output (mV) at f_0	Distortion Factor (%) max. at f_0	Demodulation 3db Bandwidth (kHz) min.	Detection System	IC
CDA10.7MG1-A	25 min.	1.0 (0.1)	345 (500)	Quadrature	CX20029
					CX20111
CDA10.7MG16-A	60-90 min.	0.9 (0.5)	300 (370)	Quadrature	TAB122AN/AF
CDA10.7MG48-A	700 min.	1.0 (0.2)	400 (560)	Quadrature	LA1835
CDA10.7MC1-A	35 min.	1.0 (0.2)	242 (370)	Quadrature	CXA1019M
					CX20091

□ Indicates frequency 4.5, 5.5, 5.74, 6.0, 6.5 MHz are available. Note that part numbers, circuits and ratings vary according to the IC used at detector process. () Typical value

PART NUMBERING SYSTEM

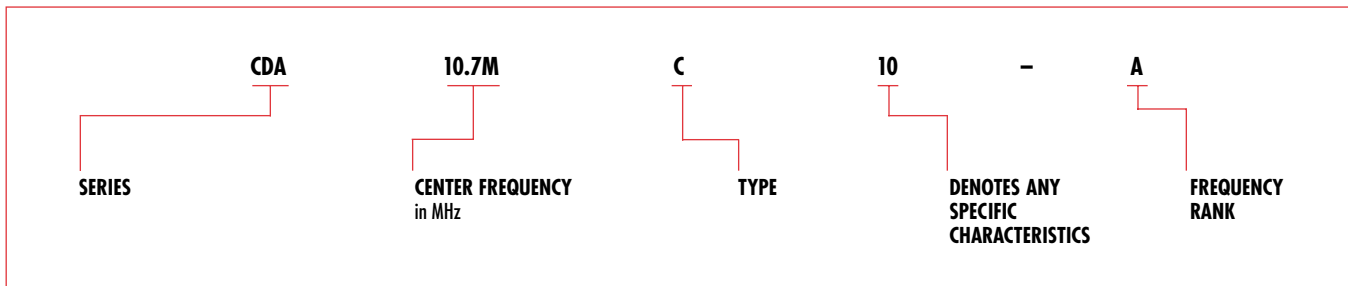

*Applicable in North American market only. ▼Applicable in European market only.
For more detailed information regarding this product line in North America, see Catalog No. P-05-D. To receive additional information on Murata Products call 1-800-831-9172.
For more detailed information regarding this product line in Europe, see Catalog No. P61E-4.

FILTERS

FM DISCRIMINATORS—CHIP TYPE

CDACV SERIES



When using chip components in the design of FM radios, their arrangement and space allocation can create design difficulties. To help reduce these problems, Murata has developed this series of chip ceramic discriminators. They have heat resistant structures and allow the design of FM detecting circuits requiring no adjustment. Also, these discriminators yield stable demodulation characteristics. The CDACV10.7 Series can be used as kits with the Cerafil® SFECV10.7 Series to facilitate design.

FEATURES

- The discriminator is only 1.5mm thick so it is well suited for thin circuit boards.
- This discriminator can be used with a variety of ICs.
- It exhibits demodulation characteristics over a wide frequency range without the need for adjustment.
- The series has excellent temperature characteristics and good aging stability.

DIMENSIONS: mm

NEW CDACV10.7 SERIES

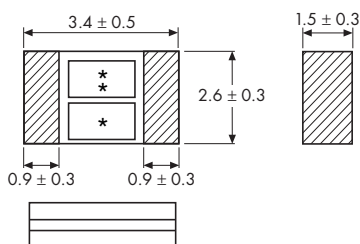

* : EIA-J Date Code
** : Center Frequency Rank Code

SPECIFICATIONS

Part Number	Demodulation Output (mV) min.	Demodulation Factor (%) max.	Demodulation 3dB Bandwidth (kHz) min.
CDACV10.7MG1-A	55	1.0	$f_0 \pm 150$
CDACV10.7MG16-A	60	0.9	$f_0 \pm 300$
CDACV10.7MG46-A	280	1.5	$f_0 \pm 330$

• 30% Dev.

PART NUMBERING SYSTEM

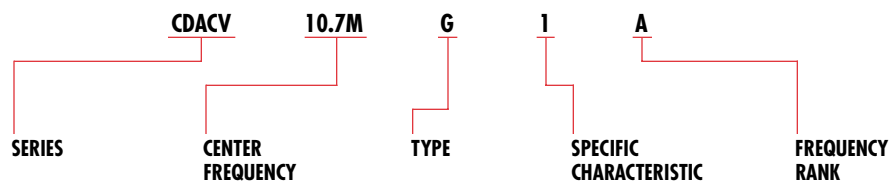

*Applicable in North American market only. ▼Applicable in European market only.
For more detailed information regarding this product line in North America, see Catalog No. P-05-D. To receive additional information on Murata Products call 1-800-831-9172.
For more detailed information regarding this product line in Europe, see Catalog No. P61E-4.

FILTERS

FILTERS FOR FM APPLICATIONS SFECV 10.7MHz



FEATURES

- Super-thin. Only 1.5mm. The most suitable ceramic filter available for thinning substrates.
- Heat resistant. Reflow soldering can be performed because of its excellent heat resistance.
- The piezoelectric element is connected in the sandwich shape by heat resistant substrates, thus it has excellent mechanical strength, and it is suitable for automatic mounting.

- Various bandwidths are available. Select a suitable type in accordance with the desired selectivity.
- Electrical characteristics are the same as conventional ceramic filters.

DIMENSIONS: mm

NEW

SFECV10.7MA5/MS2/MS3

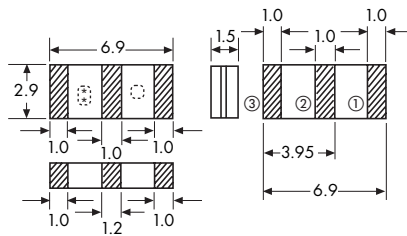

⊖ : EIAJ Date Code

- ① INPUT
- ② GROUND
- ③ OUTPUT

Packaging Units: 2000pcs/reel (180 mmD)

SPECIFICATIONS

Part Number	3dB Pass Bandwidth (kHz)	20dB Attenuation Bandwidth (kHz) max.	Insertion Loss (dB) max.	Spruious Attenuation (9 ~ 12MHz) (dB) min.
SFECV10.7MA5-Z	280 ± 50	590	3.0 ± 2.0	35
SFECV10.7MS2-Z	230 ± 50	510	3.5 ± 2.0	35
SFECV10.7MS3-Z	180 ± 40	470	4.0 ± 2.0	35

PART NUMBERING SYSTEM

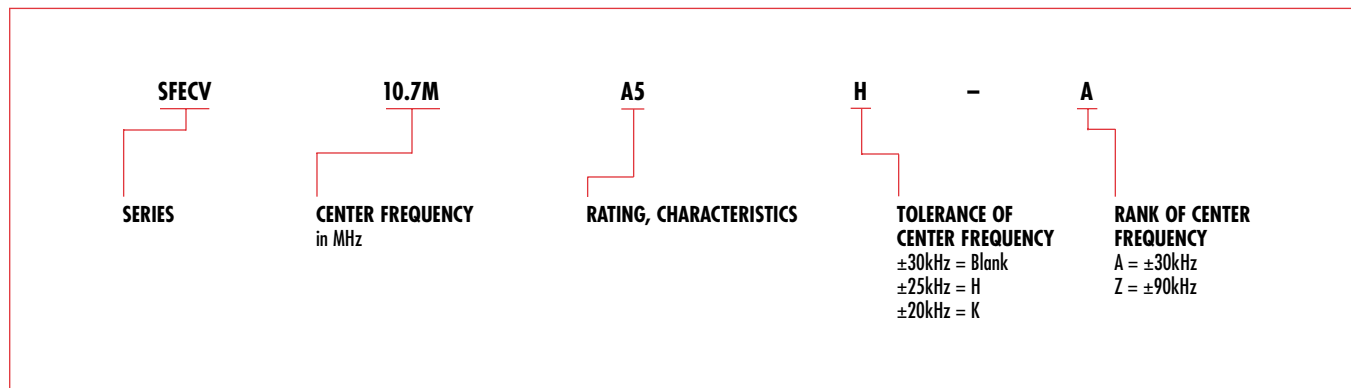

*Applicable in North American market only †Applicable in European market only
For more detailed information regarding this product line in North America, see Catalog No. P-05-D. To receive additional information on Murata Products call 1-800-831-9172.
For more detailed information regarding this product line in Europe, see Catalog No. P61E-4.

FILTERS

FOR AM AND FM APPLICATIONS

CFZC/CFWC SERIES



The CFWC455CZ Series consist of 6 ceramic elements. The filters are recommended for digital communication applications and are perfect in hand held cellular phones.

- The filters are wide bandwidth, flat G.D.T. within pass band.
- Operating temperature range: -20°C to +75°C.
- Storage temperature range: -40°C to +85°C.

FEATURES

- The filters are mountable by automatic placers.
- The filters can be reflow soldered.
- They are slim, at only 3.0mm maximum thickness, and have a small mounting area (11.5 x 7.5mm²) enable flexible PCB design.

DIMENSIONS: mm

NEW CFWC455/
CFZC455

ZC2
Input Marking

Sealing

① INPUT
② OUTPUT
③④ GROUND
Body color: Cream
Tol. without notice: ±0.3mm

⊖ : EIA-J Date Code

SPECIFICATIONS

Part Number	Nominal Center Frequency (f ₀) (kHz)	3dB Bandwidth (from f ₀) (kHz) max.	Stop Band Attenuation				Spurious Response		Insertion Loss (at f ₀) (dB) max.	Ripple (dB)	G.D.T. Ripple Deviation (μsec.)	Input/Output Impedance (kΩ)
			at f ₀ ±16kHz (dB) min.	at f ₀ ±25kHz (dB) min.	within f ₀ ±40 – ±50kHz (dB) min.	within f ₀ ±100kHz (dB) min.	within 0.1–1MHz (dB) min.	within 555–675kHz (dB) min.				
CFZC455CZ	455	±10.5 to ±13.0	—	30	55	55	40	20	8.5	(±10.5kHz) 0.5 max.	(±10.5kHz) 20 max.	1.0
CFZC455CZ2	455	±9.0 to ±11.5	6.5	40	55	53	20	—	8.5	(±9kHz) 0.5 max.	(±9kHz) 20 max.	1.0
CFWC455CZ	455	±10.5 to ±13.0	—	30	55	50	40	20	6.0	(±10.5kHz) 0.5 max.	(±10.5kHz) 27 max.	1.0
CFWC455CZ2	455	±9.0 to ±11.5	6.5	40	55	50	20	—	6.0	(±9kHz) 0.5 max.	(±9kHz) 27 max.	1.0

Note: For tape and reel packaging, the suffix is "–TC." For example, CFWC455CZ–TC.

PART NUMBERING SYSTEM



*Applicable in North American market only *Applicable in European market only
 For more detailed information regarding this product line in North America, see Catalog No. P-05-D. To receive additional information on Murata Products call 1-800-831-9172.
 For more detailed information regarding this product line in Europe, see Catalog No. P05E-8.

FILTERS FOR COMMUNICATION APPLICATIONS—HIGHLY SELECTIVE CFWS SERIES



For synthesizers, the available center frequencies are 450, 459 and 468kHz. Standard tolerance is ± 1 kHz. Because of excellent shape factor, wide-band width and high selectivity, this series is the most suitable to car radios and all-band radios.

- Operating temperature range: -20°C to $+80^{\circ}\text{C}$
- Storage temperature range: -40°C to $+85^{\circ}\text{C}$

FEATURES

- Low profile, high selectivity
- Easily mountable on any PC board.

DIMENSIONS: mm

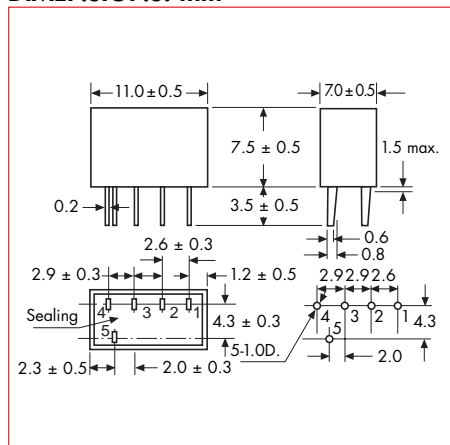

CIRCUIT

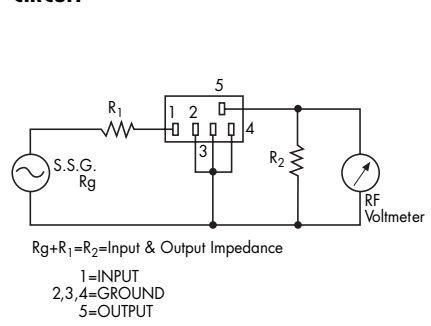

CHARACTERISTICS

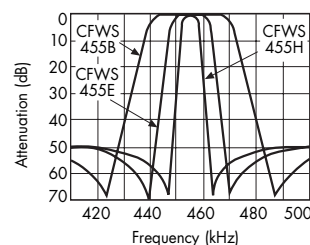

SPECIFICATIONS

CFWS 455 kHz

Part Number	Nominal Center Frequency (kHz)	6dB Bandwidth (kHz) min.	40dB Bandwidth (kHz) max.	Attenuation 455±100kHz (dB) min.	Ripple (dB) max. kHz	Insertion Loss (dB) max.	Input/Output Impedance (Ω)
*CFWS455B	455	± 15	± 30	35	3 (455 \pm 10)	4	1500
*CFWS455C	455	± 12.5	± 24	35	3 (455 \pm 8)	4	1500
*CFWS455D	455	± 10	± 20	35	3 (455 \pm 7)	4	1500
*CFWS455E	455	± 7.5	± 15	35	3 (455 \pm 5.0)	6	1500
*CFWS455F	455	± 6	± 12.5	35	3 (455 \pm 4)	6	2000
*CFWS455G	455	± 4.5	± 10	35	2 (455 \pm 3)	6	2000
CFWS455HT	455	± 3	± 9	60	2 (455 \pm 2)	6	2000
CFWS455IT	455	± 2	± 7.5	60	2 (455 \pm 1.5)	7	2000

Note: For safety purposes, connect the output of filters to the IF amplifier through a DC blocking capacitor. Avoid applying a direct current to the output of ceramic filters.

PART NUMBERING SYSTEM

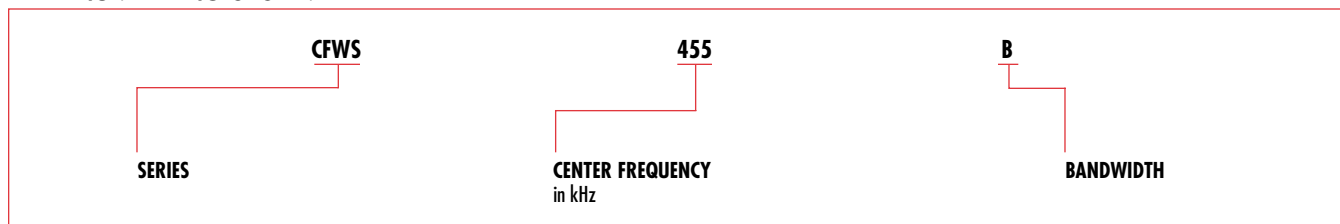

* Available as standard through authorized Murata Electronics Distributors. * Applicable in North American market only. † Applicable in European market only. For more detailed information regarding this product line in North America, see Catalog No. P-05-D. To receive additional information on Murata Products call 1-800-831-9172. For more detailed information regarding this product line in Europe, see Catalog No. P05E-8 and P10E-2.

CERAMIC FILTERS FOR AM APPLICATIONS—HIGHLY SELECTIVE CFU SERIES

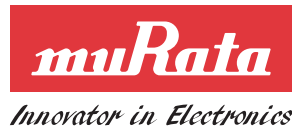

The CFU 455 line of ceramic filters are 4-element devices connected in ladder form while the CFWS 455 line of ceramic filters contain 6-elements. These compact, highly selective filters are recommended for use in applications ranging from two-way radio to auxiliary filters in high class transceivers. (Also available in 450kHz version.)

- The pass bandwidths from 30kHz to 4kHz are available.
- Easily mountable onto printed boards
- Operating temperature range: -20°C to +80°C
Storage temperature range: -40°C to +85°C

FEATURES

- High selectivity

DIMENSIONS: mm

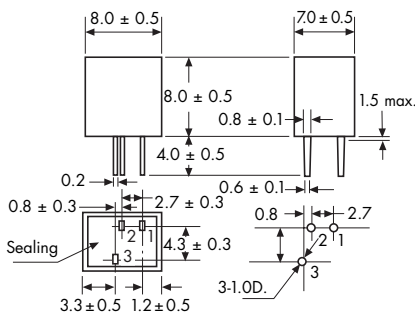

CIRCUIT

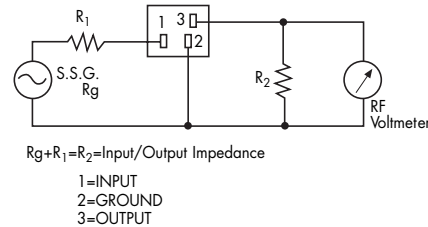

CHARACTERISTICS

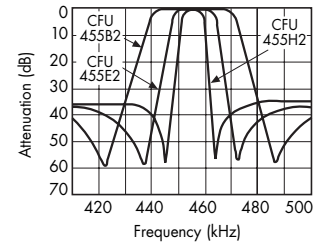

SPECIFICATIONS

CFU 455kHz

Part Number	Nominal Center Frequency (kHz)	6dB Bandwidth (kHz) min.	40dB Bandwidth (kHz) max.	Attenuation 455±100kHz (dB) min.	Ripple (dB) max. kHz	Insertion Loss (dB) max.	Input/Output Impedance (Ω)
★CFU455B2	455 ± 2	±15	±30	27	3 (455 ± 10)	4	1500
★CFU455C2	455 ± 2	±12.5	±24	27	4 (455 ± 8)	4	1500
★CFU455D2	455 ± 1.5	±10	±20	27	2 (455 ± 7)	4	1500
★CFU455E2	455 ± 1.5	±7.5	±15	27	1.5 (455 ± 5)	6	1500
★CFU455F2	455 ± 1.5	±6	±12.5	27	1.5 (455 ± 4)	6	2000
★CFU455G2	455 ± 1	±4.5	±10	25	1.5 (455 ± 3.0)	6	2000
★CFU455H2	455 ± 1	±3	±9	25	2 (455 ± 2.0)	6	2000
★CFU455I2	455 ± 1	±2	±7.5	25	2 (455 ± 1.5)	6	2000
CFU455HT	455 ± 1	±3	±9	35	3 (455 ± 2)	6	2000
CFU455IT	455 ± 1	±2	±7.5	35	2 (455 ± 1.5)	6	2000

Note: For safety purposes, connect the output of filters to the IF amplifier through a DC blocking capacitor. Avoid applying a direct current to the output of ceramic filters.

PART NUMBERING SYSTEM

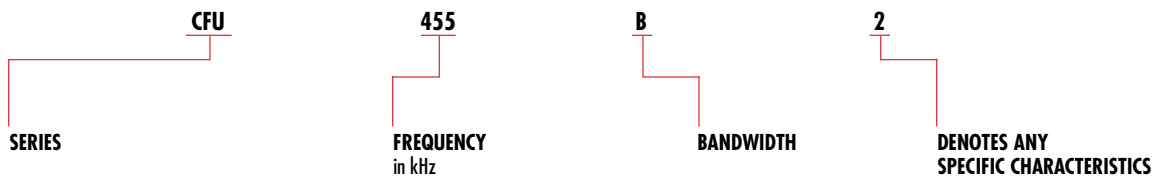

★ Available as standard through authorized Murata Electronics Distributors. * Applicable in North American market only. ▼ Applicable in European market only.
For more detailed information regarding this product line in North America, see Catalog No. P-05-D. To receive additional information on Murata Products call 1-800-831-9172.
For more detailed information regarding this product line in Europe, see Catalog No. P05E-8.

FILTERS

FOR COMMUNICATIONS EQUIPMENT CFUCG/CFUCG□X/SFGCG SERIES

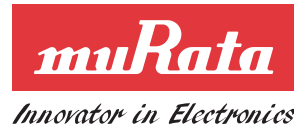

The CFUCG455□ Series comprises small, high performance, 4.0mm thin filters consisting of 4 ceramic elements. Their innovative construction is perfect for shrinking mobile communication products such as pocket pagers and cellular phones.

In addition, CFUCG455□X Series filters exhibit an extremely flat G.D.T. characteristic combined with a narrow bandwidth. The filters are recommended for narrow band digital communication applications.

The SFGCG455□ Series filters exhibit an extremely flat G.D.T. characteristic as well, and are recommended for digital communication applications and are perfect in hand held cellular phones, etc.

FEATURES

- Mountable by automatic placers
- Can be reflow soldered and can withstand washing
- 4.0mm maximum thickness, with small mounting area (7.5 x 6.0mm²) enabling flexible PCB design
- Bandwidth range from D to G

DIMENSIONS: mm

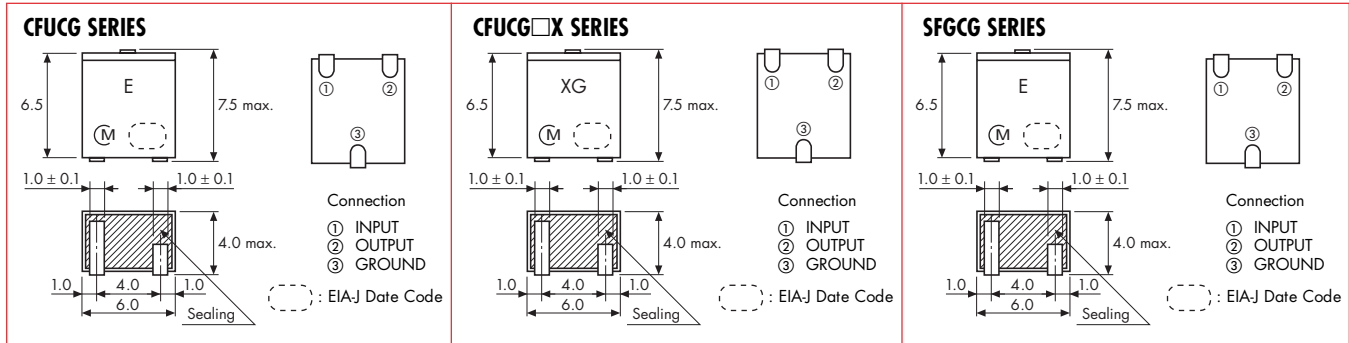

SPECIFICATIONS

Part Number	Center Frequency (Center of 6dB B.W.) (kHz)	6dB Bandwidth (kHz min.)	40dB Bandwidth (kHz max.)	Stop Band Attenuation (455 ± 100kHz) (dB min.)	Insertion Loss at minimum loss point (dB max.)	Ripple (dB max.)	GDT Ripple Deviation (μsec, max.)	Input/Output Impedance (Ω)
CFUCG Series								
CFUCG455D	455 ± 1.5	±10	±20	27	4	(±7kHz) 2.0	—	1500
CFUCG455E	455 ± 1.5	±7.5	±15	27	6	(±5kHz) 1.5	—	1500
CFUCG455F	455 ± 1.5	±6.0	±12.5	27	6	(±4kHz) 1.5	—	1500
CFUCG455G	455 ± 1.0	±4.5	±10	25	6	(±3kHz) 1.5	—	1500
CFUCG□X Series (Narrow Bandwidth G.D.T. Flat Type)								
CFUCG455EX	455 ± 1.5	±7.5	±17.5	27	6	(±5kHz) 1.0	(±5kHz) 25	1500
CFUCG455FX	455 ± 1.0	±6.0	±15.0	27	6	(±4kHz) 1.0	(±4kHz) 25	1500
CFUCG455GX	455 ± 1.0	±4.5	±12.5	25	6	(±3kHz) 1.0	(±3kHz) 25	1500
CFUCG455HX	455 ± 1.0	±3.0	±10.0	25	7	(±2kHz) 1.0	(±2kHz) 25	1500
SFGCG Series								
SFGCG455AX	455 ± 2.0	±17.5	±40	25	4	(±12kHz) 1.0	(±12kHz) 15	1000
SFGCG455BX	455 ± 1.5	±15	±35	25	5	(±10kHz) 1.0	(±10kHz) 15	1000
SFGCG455CX	455 ± 1.5	±12.5	±30	25	6	(±8kHz) 1.0	(±8kHz) 15	1000
SFGCG455DX	455 ± 1.0	±10	±25	23	7	(±7kHz) 1.0	(±7kHz) 20	1500
SFGCG455EX	455 ± 1.0	±7.5	±20	23	8	(±5kHz) 1.0	(±5kHz) 20	1500

Note: For safety purposes, connect the output of filters to the IF amplifier through a DC blocking capacitor. Avoid applying a direct current to the output of ceramic filters.

PART NUMBERING SYSTEM

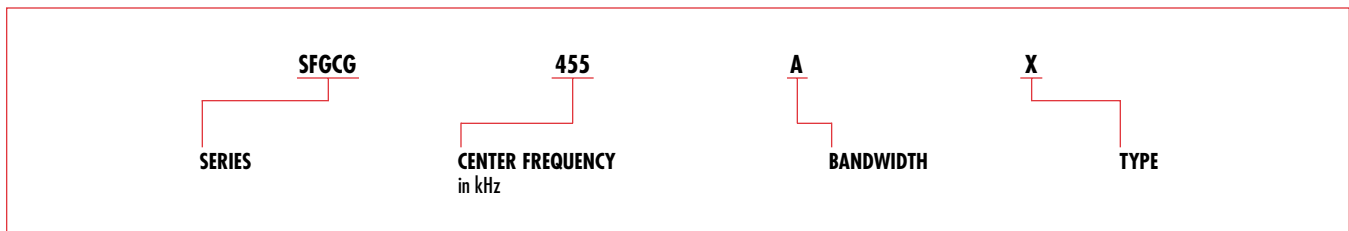

▲Applicable in North American market only. ▼Applicable in European market only.

For more detailed information regarding this product line in North America, see Catalog No. P-05-D. To receive additional information on Murata Products call 1-800-831-9172. For more detailed information regarding this product line in Europe, see Catalog No. P05E-8.

FILTERS

IF FILTER FOR CELLULAR PHONES

CFECV SERIES



The CFECV Series are small, high performance and super thin (1.5mm) filters. Piezoelectric element is connected in the sandwich shape by heat resistant substrate. The filters exhibit flat G.D.T characteristic in pass band. The filters are recommended for digital communication application and are perfect in hand held cellular phones, pocket cordless phones, etc.

FEATURES

- The filters are mountable by automatic placers
- They are slim, at only 1.5mm thickness, and have a small mounting area (6.9 x 2.9mm²) enabling flexible PCB design.
- Operating temperature range: -10°C to +60°C

DIMENSIONS: mm

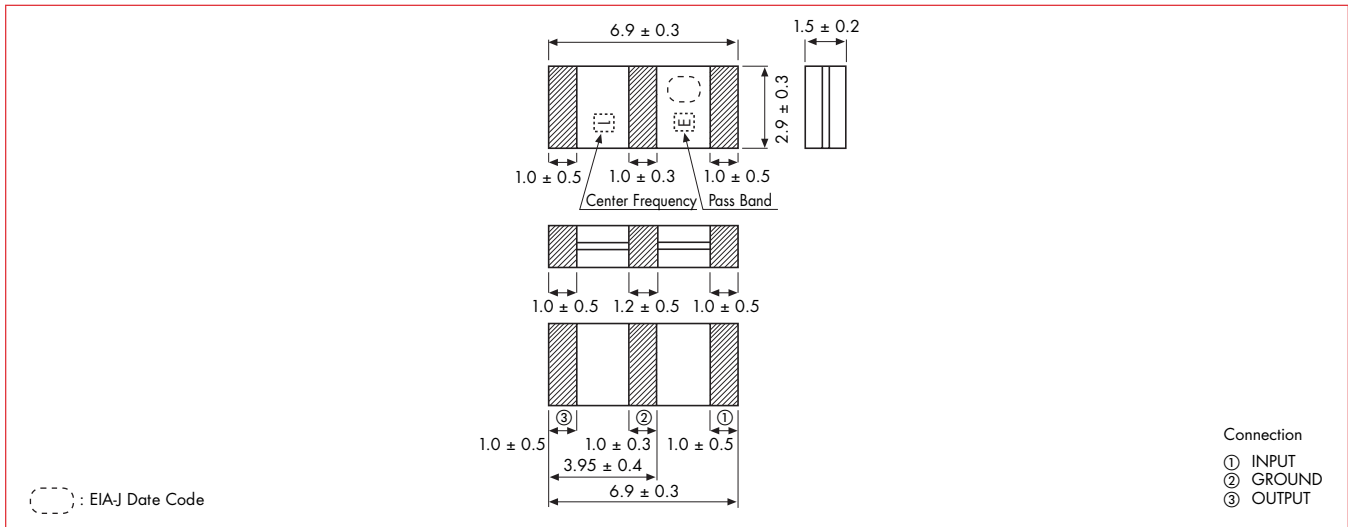

SPECIFICATIONS

Part Number	2dB Bandwidth		Stopband Attenuation		Spurious		Ripple	GDF Deviation Within 13MHz ± 90kHz	Input/Output Impedance
	13.00	±90MHz min.	Fn ± 400kHz	Fn ± 500kHz	11 ~ 15MHz	Insertion Loss at fn			
CFECV13.0ME21	13.00	±90MHz min.	25dB min.	35dB min.	30dB min.	6dB max.	1.0dB max.	1.5psec max.	330Ω

(10.8MHz available)

PART NUMBERING SYSTEM

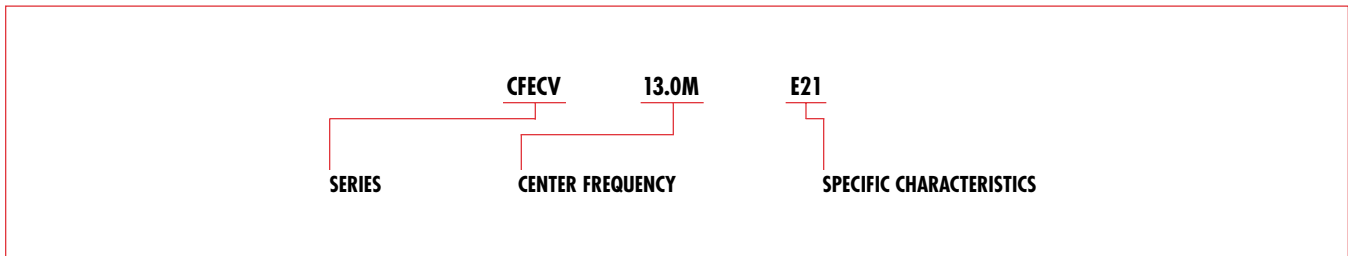

▲Applicable in North American market only. ▼Applicable in European market only.
 For more detailed information regarding this product line in North America, see Catalog No. P-05-D. To receive additional information on Murata Products call 1-800-831-9172.
 For more detailed information regarding this product line in Europe, contact us.

FILTERS

FILTERS

WIDE OR NARROW BAND

SFE MA/MHY/MT/MV/MFP 10.7MHz

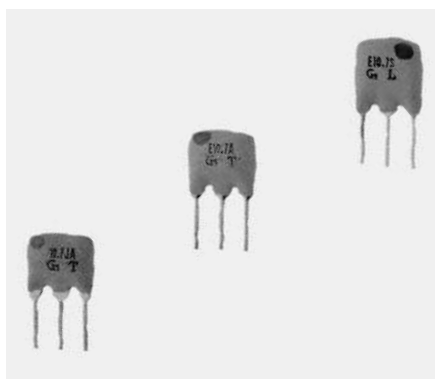

The following filters were developed to offer both narrower and wider bandwidth characteristics for use in products such as DBS receivers. These filters also retain the same reliability that is available with our standard filters. The various bandwidths allow these filters to be utilized in a multitude of new communication applications.

- Temperature characteristics are the best available, the same as those of Murata's conventional ceramic filters. Thus, even in the case of narrow band filters, the center frequency is stable even if temperature changes.

FEATURES

- Realizes wider or narrower band characteristics not obtained by conventional ceramic filters.

DIMENSIONS: mm

MA19 SERIES	MT SERIES	MV SERIES	MFP SERIES	TEST CIRCUIT
○ : EIA-J Date Code	○ : EIA-J Date Code	○ : EIA-J Date Code	○ : EIA-J Date Code	$R_g + R_1 = R_2 =$ Input/Output Impedance $C = 10\text{pF}$ (including stray capacitance and input capacitance of RF Voltmeter)
				① INPUT ② GROUND ③ OUTPUT

SPECIFICATIONS

SFE MA/MHY/MT/MV/MFP 10.7MHz

	Part Number	3dB Bandwidth (kHz)	20dB Bandwidth (kHz) max.	Ripple Within 3dB Bandwidth (dB)	Insertion Loss (dB) max.	Spurious (9~12MHz) (dB) min.
Wide Bandwidth Series	SFE10.7MA19	350 min. (450)	950 (750)	3 max.	3 ± 2	20 (30)
	SFE10.7MA20-A	330 ± 50	680 (615)	1 max.	4 ± 2	30 (40)
	SFE10.7MA21	400 (500)	950 (750)	3 max.	3 ± 2	20 (30)
	SFE10.7MHY-A	110 ± 30	350 (260)	1 max.	7 ± 2	30 (38)
• Input/output impedance: 330Ω (MA20-A, MHY-A), 470Ω (MA19) () Typical value • Center frequency 10.52MHz types of SFE10.7MHY-A is also available.						
Narrow Bandwidth Series	SFE10.7MT	±25 (80)	200 (160)	1 max.	6.5 ± 2.5	30 (55)
	SFE10.7MV	±13 (53)	135 (109)	1 max.	6.0 ± 2.0	30 (50)
	SFE10.7MFP	±20 (38)	95 (78)	1 max.	6.0 (3.4)	24 (28)
• Input/output impedance: 330 (MT,MV), 600Ω (MFP) () Typical value • Spurious range of SFE10.7MFP: 10.7 ± 1MHz.						

PART NUMBERING SYSTEM

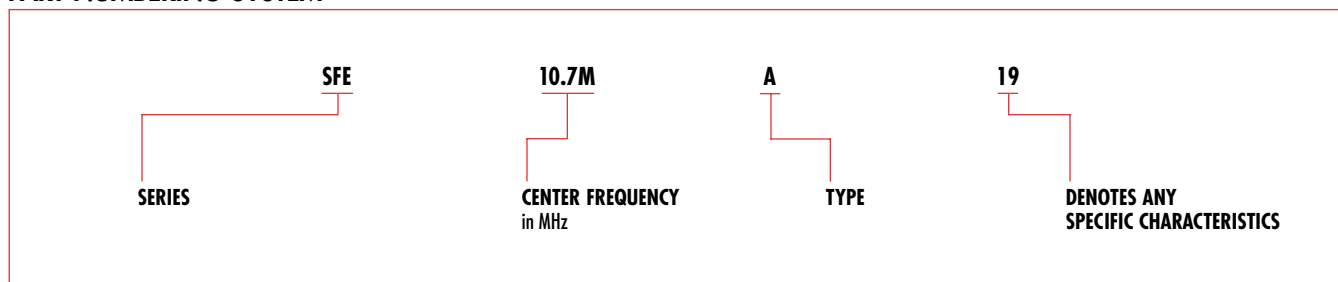

*Applicable in North American market only. ▼Applicable in European market only.
 For more detailed information regarding this product line in North America, see Catalog No. P-05-D. To receive additional information on Murata Products call 1-800-831-9172.
 For more detailed information regarding this product line in Europe, see Catalog No. P61E-4.

FILTERS FOR COMMUNICATIONS EQUIPMENT

RESIN MOLDED—HIGHLY SELECTIVE

CFUM/CFWM 450/455kHz SERIES

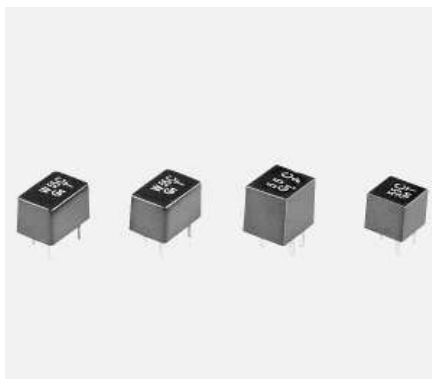

The CFUM and CFWM lines of ceramic filters are miniaturized versions of the CFU/CFWS lines. These ultra-miniature versions consume approximately 40% less volume while still offering the same high performance filter characteristics available with the CFU/CFWS lines. They are available in 450kHz and 455kHz versions.

DIMENSIONS: mm

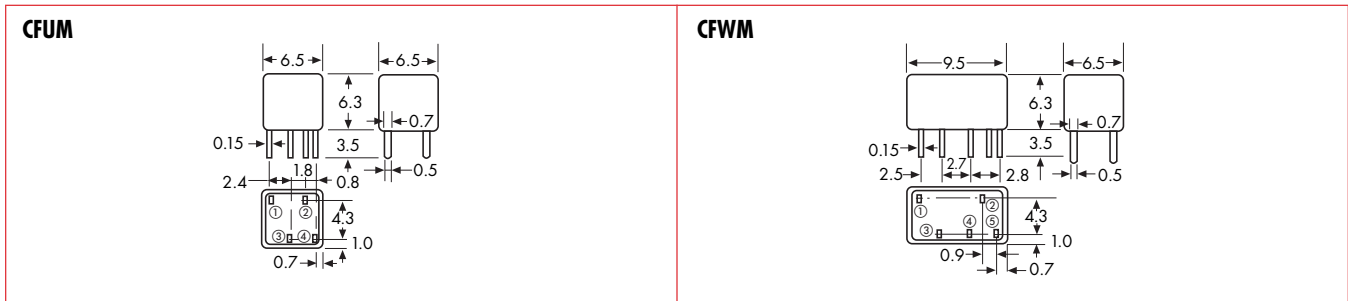

SPECIFICATIONS

Part Number	Nominal Center Frequency (kHz)	6dB Bandwidth (kHz) min.	40dB Bandwidth (kHz) max.	Attenuation 455±100kHz (dB) min.	Ripple (dB) max. kHz	Insertion Loss (dB) max.	Input/Output Impedance (Ω)
*CFUM455B	455	±15	±30	27	—	4	1500
*CFUM455C	455	±12.5	±24	27	—	4	1500
*CFUM455D	455	±10	±20	27	2 (455 ± 7.0)	4	1500
*CFUM455E	455	±7.5	±15	27	1.5 (455 ± 5.0)	6	1500
*CFUM455F	455	±6	±12.5	27	1.5 (455 ± 4.0)	6	2000
*CFUM455G	455	±4.5	±10	25	1.5 (455 ± 3.0)	6	2000
*CFUM455H	455	±3	±9	35	1.5 (455 ± 2.0)	6	2000
*CFUM455I	455	±2	±7.5	35	2 (455 ± 1.5)	7	2000
*CFWM455B	455	±15	±30	35	3 (455 ± 10.0)	4	1500
*CFWM455C	455	±12.5	±24	35	3 (455 ± 8.0)	4	1500
*CFWM455D	455	±10	±20	35	3 (455 ± 7.0)	4	1500
*CFWM455E	455	±7.5	±15	35	3 (455 ± 5.0)	6	1500
*CFWM455F	455	±6	±12.5	35	3 (455 ± 4.0)	6	2000
*CFWM455G	455	±4.5	±10	35	2 (455 ± 3.0)	6	2000
*CFWM455H	455	±3	±9	55	2 (455 ± 2.0)	6	2000
*CFWM455I	455	±2	±7.5	55	2 (455 ± 1.5)	7	2000

- CFUM455□ series filters are 4-element ceramic filters and ultraminiature versions of CFU455□2 series.
- CFWM455□ series filters are 6-element ceramic filters and ultraminiature versions of CFWS455□ series.

PART NUMBERING SYSTEM

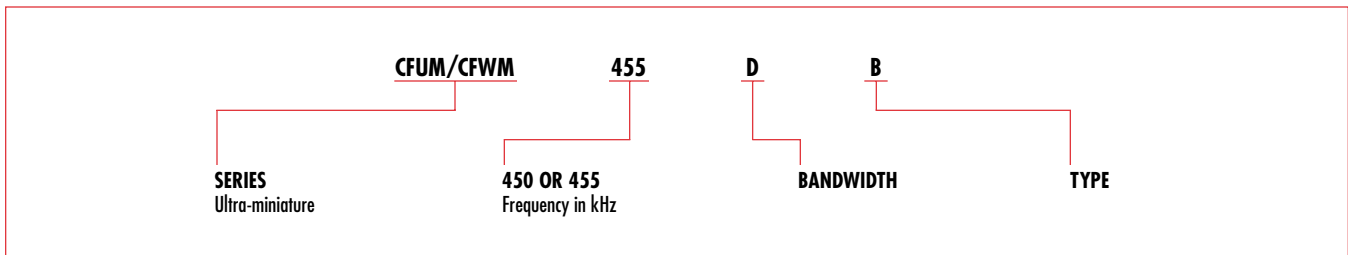

*Available as standard through authorized Murata Electronics Distributors. *Applicable in North American market only. *Applicable in European market only.
 For more detailed information regarding this product line in North America, see Catalog No. P-05-D. To receive additional information on Murata Products call 1-800-831-9172.
 For more detailed information regarding this product line in Europe, see Catalog No. POSE-8.

FILTERS

FILTERS FOR COMMUNICATIONS EQUIPMENT

MINIATURE, G.D.T. FLAT TYPE

CFUM/CFWM455□Y SERIES

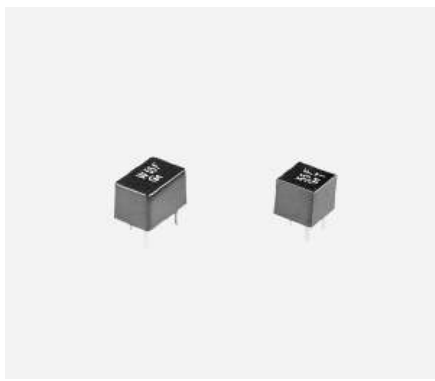

Ceramic filter CFUM/CFWM455□Y Series are miniature and high-performance filters. These filters, while only 6.3mm high, are 60% the volume of conventional types (CFUS/CFWS Series). Well suited for miniaturizing the communications equipment, especially for a cellular phone.

- Operating temperature range: -20°C to +80°C
- Storage temperature range: -40°C to +85°C
- Available for 450kHz and 455kHz

FEATURES

- Miniature, flat G.D.T. characteristics
- Suitable for a cellular phone
- A variety of bandwidths are available.

DIMENSIONS: mm

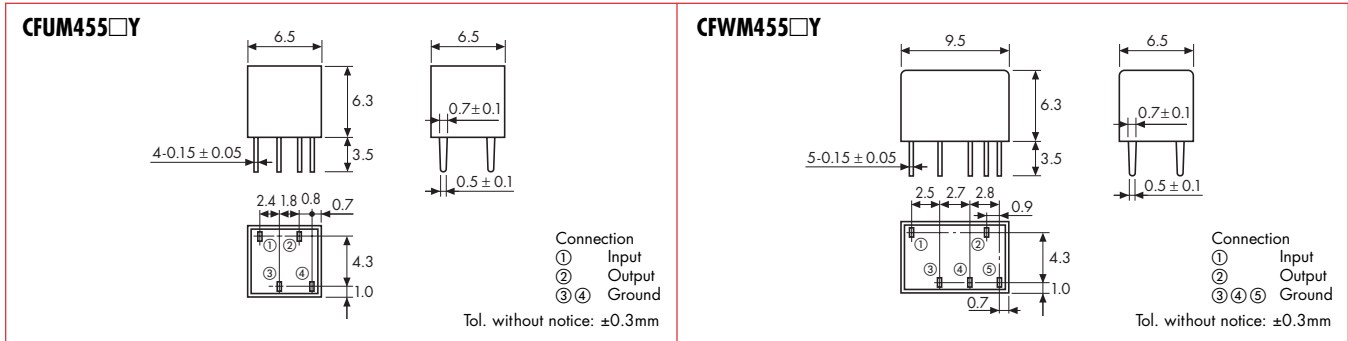

SPECIFICATIONS

Part Number	Nominal Center Frequency (kHz)	6dB Bandwidth (kHz) min.	40dB Bandwidth (kHz) max.	Attenuation 455±100kHz (dB) min.	Insertion Loss (dB) max.	Input/Output Impedance (Ω)	G.D.T. Deviation (μsec.)
CFUM455BY	455 ± 1.5	±15	±35	25	5	1500	[15] (±10kHz)
CFUM455CY	455 ± 1.5	±12.5	±30	25	6	1500	[15] (±8kHz)
CFUM455DY	455 ± 1.0	±10	±25	23	7	1500	[20] (±7kHz)
CFUM455EY	455 ± 1.0	±7.5	±20	23	8	1500	[20] (±5kHz)
CFUM455FY	455 ± 1.0	±6	±17.5	23	9	2000	[20] (±4kHz)
CFUM455GY	455 ± 1.0	±4.5	±15	23	10	2000	[20] (±3kHz)
Part Number	Nominal Center Frequency (kHz)	6dB Bandwidth (kHz) min.	50dB Bandwidth (kHz) max.	Attenuation 455±100kHz (dB) min.	Insertion Loss (dB) max.	Input/Output Impedance (Ω)	G.D.T. Deviation (μsec.)
CFWM455BY	455 ± 1.5	±15	±35	35	6	1500	[30] (±10kHz)
CFWM455CY	455 ± 1.5	±12.5	±30	35	7	1500	[30] (±8kHz)
CFWM455DY	455 ± 1.0	±10	±25	35	8	1500	[30] (±7kHz)
CFWM455EY	455 ± 1.0	±7.5	±20	35	9	1500	[30] (±5kHz)
CFWM455FY	455 ± 1.0	±6	±17.5	35	10	2000	[40] (±4kHz)
CFWM455GY	455 ± 1.0	±4.5	±15	35	13	2000	[40] (±3kHz)

- CFUM455□Y series filters are 4-element ceramic filters and miniature type of CFUS455□Y series.
- CFWM455□Y series filters are 6-element ceramic filters and miniature type of CFWS455□Y series.

PART NUMBERING SYSTEM

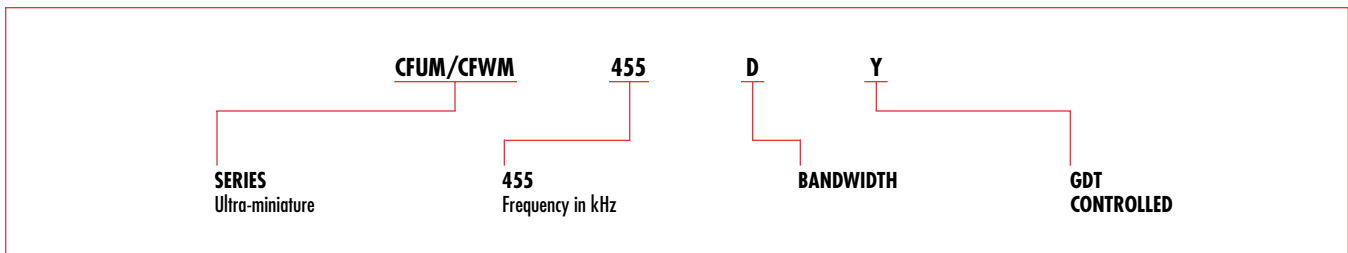

* Available as standard through authorized Murata Electronics Distributors. * Applicable in North American market only. ▼ Applicable in European market only.
 For more detailed information regarding this product line in North America, see Catalog No. P-05-D. To receive additional information on Murata Products call 1-800-831-9172.
 For more detailed information regarding this product line in Europe, see Catalog No. P05E-8.

FILTERS FOR COMMUNICATIONS EQUIPMENT

RESIN MOLDED, MULTI-ELEMENT

CFVM/CFZM SERIES



The CFVM line of ceramic filters are 7-element devices connected in ladder form while the CFZM line of filters contain 9-elements. These highly selective filters offer improved stopband attenuation and are recommended for use in a variety of applications. Available in 450kHz and 455kHz versions.

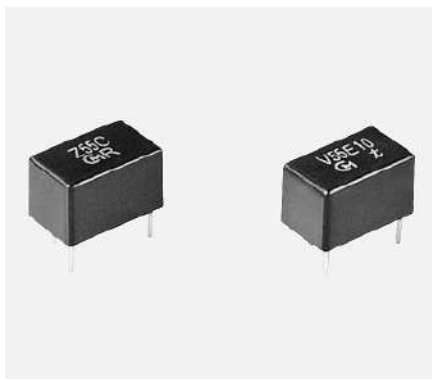

DIMENSIONS: mm

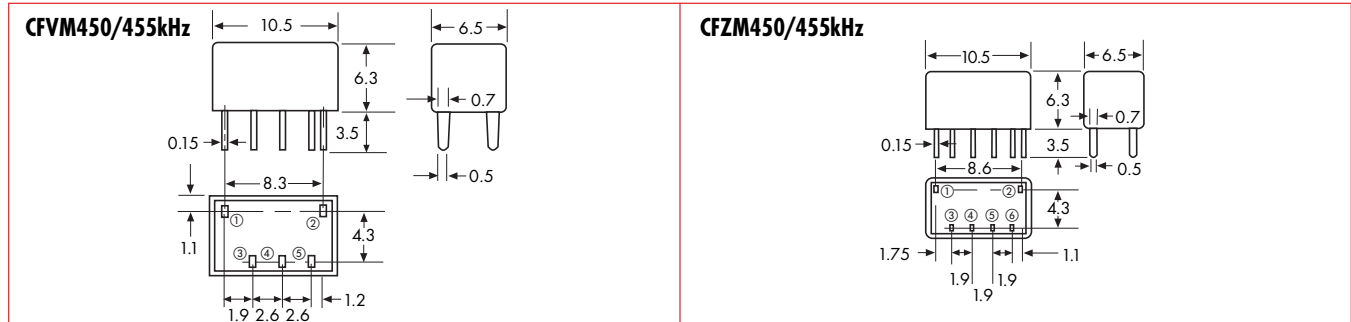

Note: For safety purposes, connect the output of filters to the IF amplifier through a DC blocking capacitor. Avoid applying a direct current to the output of ceramic filters.

SPECIFICATIONS

Part Number	Nominal Center Frequency (kHz)	3dB Bandwidth (kHz) min.	6dB Bandwidth (kHz) min.	Ripple (dB) max.	60dB Bandwidth (kHz) max.	Attenuation (dB) min.	Spurious Response (dB) min.	Insertion Loss (dB) max.	Input/Output Impedance (Ω)
CFVM455B	455	± 10	± 15	3	± 25	50	25	4	1000
CFVM455C	455	± 9	± 13	3	± 23	50	25	4	1000
CFVM455D	455	± 7	± 10	3	± 20	50	25	4	1500
CFVM455E	455	± 5.5	± 8	3	± 16	50	25	6	1500
CFVM455E10	455	± 5.0	± 7.0	3	± 12.5	50	25	6	1500
CFVM455F	455	± 4.2	± 6	3	± 12	50	25	6	1500
CFVM455G	455	—	± 4	3	± 10	50	25	6	1500
CFVM455H	455	—	± 3	3	± 7.5	50	25	6	1500
Part Number	Nominal Center Frequency (kHz)	3dB Bandwidth (kHz) min.	6dB Bandwidth (kHz) min.	Ripple (dB) max.	70dB Bandwidth (kHz) max.	Attenuation (dB) min.	Spurious Response (dB) min.	Insertion Loss (dB) max.	Input/Output Impedance (Ω)
CFZM455B	455	± 10	± 15	3	± 25	70	40	4	1000
CFZM455C	455	± 9	± 13	3	± 23	70	40	4	1000
CFZM455D	455	± 7	± 10	3	± 20	70	40	4	1500
CFZM455E	455	± 5.5	± 8	3	± 16	70	40	6	1500
CFZM455E10	455	± 5.0	± 7.5	3	± 12.5	70	40	6	1500
CFZM455F	455	± 4.2	± 6	3	± 12	70	50	6	1500
CFZM455G	455	—	± 4	3	± 10	70	50	6	1500
CFZM455H	455	—	± 3	3	± 7.5	70	50	7	1500

PART NUMBERING SYSTEM

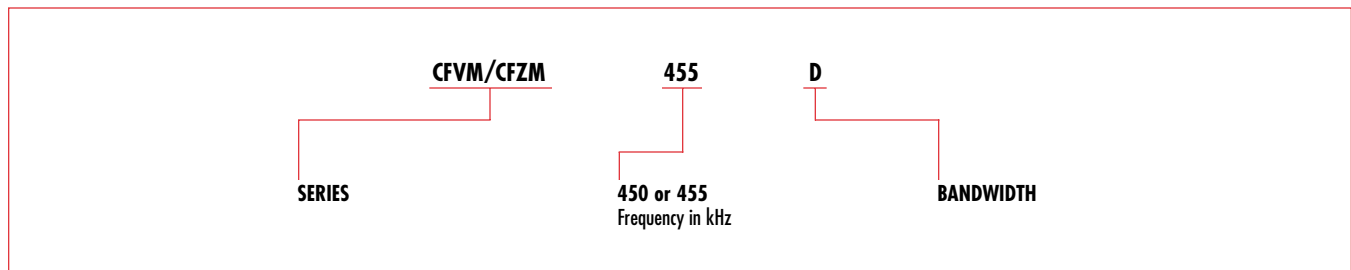

*Applicable in North American market only. *Applicable in European market only.
 For more detailed information regarding this product line in North America, see Catalog No. P-05-D. To receive additional information on Murata Products call 1-800-831-9172.
 For more detailed information regarding this product line in Europe, see Catalog No. P05E-8.

FILTERS

FILTERS FOR COMMUNICATIONS EQUIPMENT

RESIN MOLDED, MULTI-ELEMENT

CFM/CFR455 SERIES



The following lines of filters are high performance devices that achieve ultimate stopband attenuation through the use of multiple piezoelectric elements connected in ladder form. A few of the recommended applications for these filters include high class receivers, SSB communications equipment, pocket pagers and mobile radios.

CFM455 9 Ceramic Elements
CFR455 11 Elements Filters

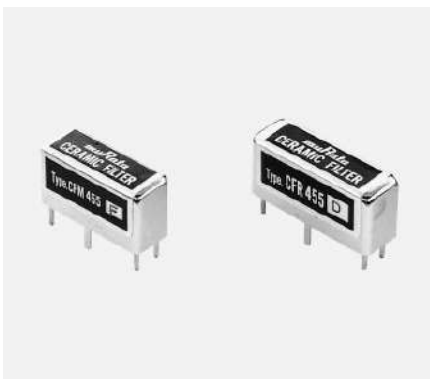

DIMENSIONS: mm

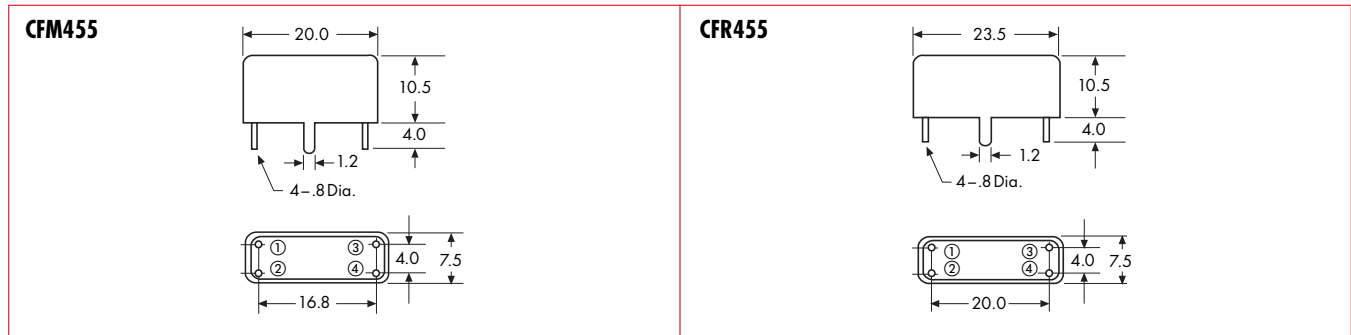

Note: For safety purposes, connect the output of filters to the IF amplifier through a DC blocking capacitor. Avoid applying a direct current to the output of ceramic filters.

SPECIFICATIONS

Part Number	Nominal Center Frequency (kHz)	3dB Bandwidth (kHz) min.	6dB Bandwidth (kHz) min.	Ripple (dB) max.	Bandwidth		Attenuation 455±100kHz (dB) min.	Spurious 0.1~1MHz (dB) min.	Insertion Loss (dB) max.	Input/Output Impedance (Ω)
					(kHz) max.	At (dB)				
CFM455A	455	±13	±17.5	3	±30	60	50	30	3	1000
CFM455B	455	±10	±15	3	±25		50	30	3	1000
CFM455C	455	±9	±13	3	±23		50	30	3	1000
CFM455D	455	±7	±10	3	±20		50	30	3	1500
CFM455E	455	±5.5	±8	3	±16		45	30	5	1500
CFM455F	455	±4.2	±6	3	±12		45	30	6	2000
CFM455G	455	—	±4	3	±10		45	30	6	2000
CFM455H	455	—	±3	3	±7.5		45	30	6	2000
CFM455I	455	—	±2	3	±5		45	30	7	2000
CFR455A	455	±13	±17.5	3	±30	70	60	40	4	1000
CFR455B	455	±10	±15	3	±25		60	40	4	1000
CFR455C	455	±9	±13	3	±23		60	40	4	1000
CFR455D	455	±7	±10	3	±20		60	40	4	1500
CFR455E	455	±5.5	±8	3	±16		55	40	6	1500
CFR455F	455	±4.2	±6	3	±12		55	40	6	2000
CFR455G	455	—	±4	3	±10		55	40	6	2000
CFR455H	455	—	±3	3	±7.5		55	40	7	2000
CFR455I	455	—	±2	3	±5		55	40	8	2000
CFR455J	455	—	±1.5	3	±4.5	55	40	8	2000	

PART NUMBERING SYSTEM

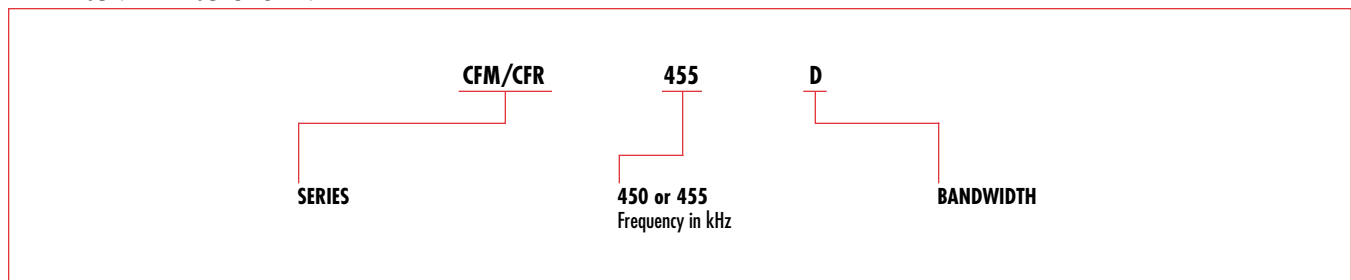

*Applicable in North American market only. *Applicable in European market only.
 For more detailed information regarding this product line in North America, see Catalog No. P-05-D. To receive additional information on Murata Products call 1-800-831-9172.
 For more detailed information regarding this product line in Europe, see Catalog No. P05E-8.

FILTERS

FOR COMMUNICATIONS EQUIPMENT—RESIN MOLDED MULTI-ELEMENT—CFG/CFK/CFX SERIES



CF□ Series ceramic filters are high-performance filters, which consist of piezoelectric elements connected in a ladder form. They can be widely used as intermediate-frequency filters in various high-class receivers, SSB communications equipment, mobile radio set.

- Variety of bandwidths available to suit your needs
- Operating temperature range: -20°C to +80°C
- Storage temperature range: -40°C to +85°C

FEATURES

- High selectivity
- Stable operation in a wide temperature range

DIMENSIONS: mm

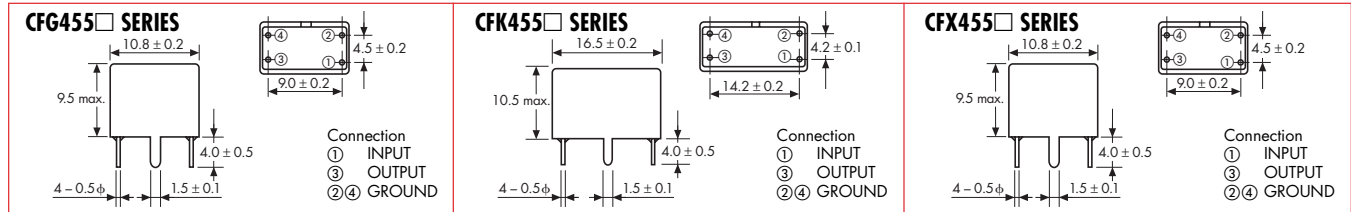

SPECIFICATIONS

Part Number	Nominal Center Frequency (kHz)	3dB Bandwidth (kHz) min.	6dB Bandwidth (kHz) min.	Ripple (dB) max.	60dB Bandwidth (kHz) max.	Attenuation 455±100kHz (dB) min.	Spurious 0.1~1MHz (dB) min.	Insertion Loss (dB) max.	Input/Output Impedance (Ω)
CFG455□									
CFG455B	455	±10	±15	3	±25	50	25	4	1000
CFG455C	455	±9	±13	3	±23	50	25	4	1000
CFG455D	455	±7	±10	3	±20	50	25	4	1500
CFG455E	455	±5.5	±8	3	±16	50	25	6	1500
CFG455E10	455	±5.0	±7.0	3	±12.5	50	25	6	1500
CFG455F	455	±4.2	±6	3	±12	50	25	6	1500
CFG455G	455	—	±4	3	±10	50	25	6	1500
CFG455H	455	—	±3	3	±7.5	50	25	6	1500
CFG455I	455	—	±2	3	±5	50	25	6	2000
CFG455J	455	—	±1.5	3	±4.5	50	25	6	2000
CFK455□									
CFK455B	455	±10	±15	3	±25	80	50	4	1000
CFK455C	455	±9	±13	3	±23	80	50	4	1000
CFK455D	455	±7	±10	3	±20	80	50	4	1500
CFK455E	455	±5.5	±8	3	±16	80	50	6	1500
CFK455E10	455	±5.0	±7.5	3	±12.5	80	50	6	1500
CFK455F	455	±4.2	±6	3	±12	80	50	6	2000
CFK455G	455	—	±4	3	±10	80	50	6	2000
CFK455H	455	—	±3	3	±7.5	80	50	7	2000
CFK455I	455	—	±2	3	±5	80	50	8	2000
CFK455J	455	—	±1.5	3	±4.5	80	50	8	2000
CFX455□									
CFX455B	455	±10	±15	3	±25	70	40	4	1000
CFX455C	455	±9	±13	3	±23	70	40	4	1000
CFX455D	455	±7	±10	3	±20	70	40	4	1500
CFX455E	455	±5.5	±8	3	±16	70	40	6	1500
CFX455E10	455	±5.0	±7.5	3	±12.5	70	40	6	1500
CFX455F	455	±4.2	±6	3	±12	70	50	6	1500
CFX455G	455	—	±4	3	±10	70	50	6	1500
CFX455H	455	—	±3	3	±7.5	70	50	7	1500
CFX455I	455	—	±2	3	±5	70	50	8	2000
CFX455J	455	—	±1.5	3	±4.5	70	50	8	2000

PART NUMBERING SYSTEM

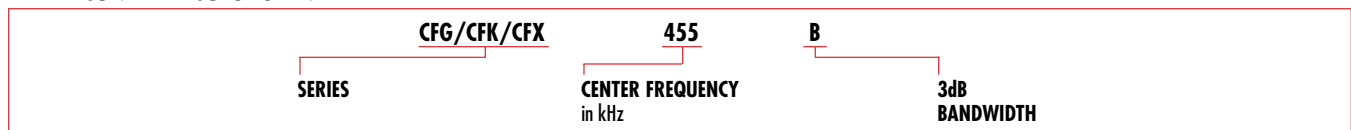

*Applicable in North American market only. *Applicable in European market only.
 For more detailed information regarding this product line in North America, consult us. To receive additional information on Murata Products call 1-800-831-9172.
 For more detailed information regarding this product line in Europe, see Catalog No. POSE-8.

FILTERS

FILTERS

FOR COMMUNICATIONS EQUIPMENT—RESIN MOLDED, MULTI-ELEMENT—CFJ/CFS/CFL455kHz



The following lines of filters are high performance devices that achieve ultimate stopband attenuation through the use of multiple piezoelectric elements connected in ladder form. A few of the recommended applications for these filters include high class receivers, SSB communications equipment, pocket pagers and mobile radios.

- CFJ455K** 11 Ceramic Elements
- CFS455** 15 Element Filters
- CFL455** 9 Element Filters (GDT Improved)

DIMENSIONS: mm

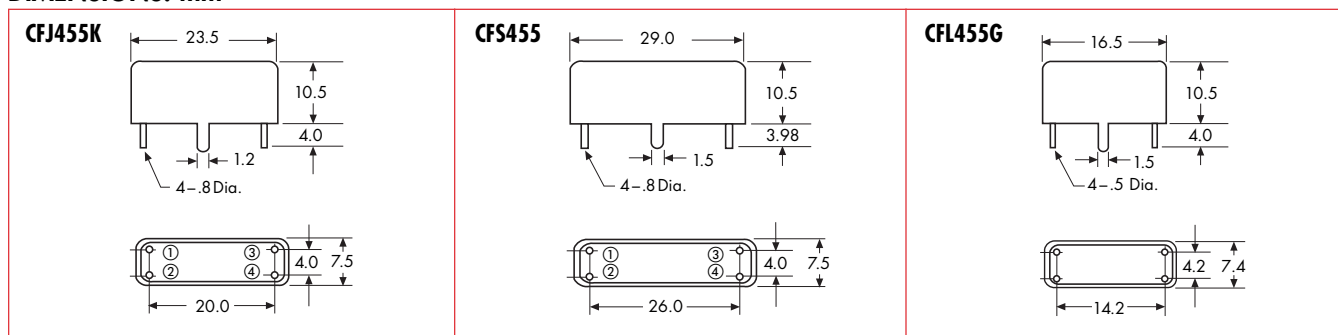

Note: For safety purposes, connect the output of filters to the IF amplifier through a DC blocking capacitor. Avoid applying a direct current to the output of ceramic filters.

SPECIFICATIONS

Part Number	Nominal Center Frequency (kHz)	3dB Bandwidth (kHz) min.	6dB Bandwidth (kHz) min.	Ripple (dB) max.	Bandwidth		Attenuation 455±100kHz (dB) min.	Spurious 0.1~1MHz (dB) min.	Insertion Loss (dB) max.	Input/Output Impedance (Ω)	Group Delay Time Dev. sec. max. (kHz)
					(kHz) max.	At (dB)					
CFJ455K5	455	—	2.4 (Total)	2	4.5 (Total)	60	—	60 ⁴⁰ at 600~700kHz	6	2000	
CFJ455K14	455	—	±1.1 ~ ±1.3	2	4.5 (Total)		—	60 ⁴⁰ at 600~700kHz	7	2000	
CFJ455K8	455	—	1.0 (Total)	1.5	3.0 (Total)		60	—	8	2000	
CFS455A	455	±13	±17.5	3	±30	80	70	50	4	1500	
CFS455B	455	±10	±15	3	±25		70	50	4	1500	
CFS455C	455	±9	±13	3	±23		70	50	4	1500	
CFS455D	455	±7	±10	3	±20		70	50	4	1500	
CFS455E	455	±5.5	±8	3	±15		70	50	6	1500	
CFS455F	455	±4.2	±6	3	±12		70	50	6	2000	
CFS455G	455	—	±4	3	±9		70	50	6	2000	
CFS455H	455	—	±3	3	±7.5		70	50	7	2000	
CFS455I	455	—	±2	3	±5		70	50	8	2000	
CFS455J	455	—	±1.5	3	±4.5		60	50	8	2000	
CFL455BG5	455	±10.5	±13.5	0.5	±100	60	60	30	10	1000	25μ (455±10.5)
CFL455CG1	455	±9.5	±12.0	0.5	±25.5		60	30	10	1000	35μ (455±9.5)
CFL455DG2	455	±7.0	±9.0	0.5	±100		60	30	11	1000	35μ (455±7)
CFL455EG1	455	±5.0	±7.0	0.5	±18		60	30	13	1500	30μ (455±5)

PART NUMBERING SYSTEM

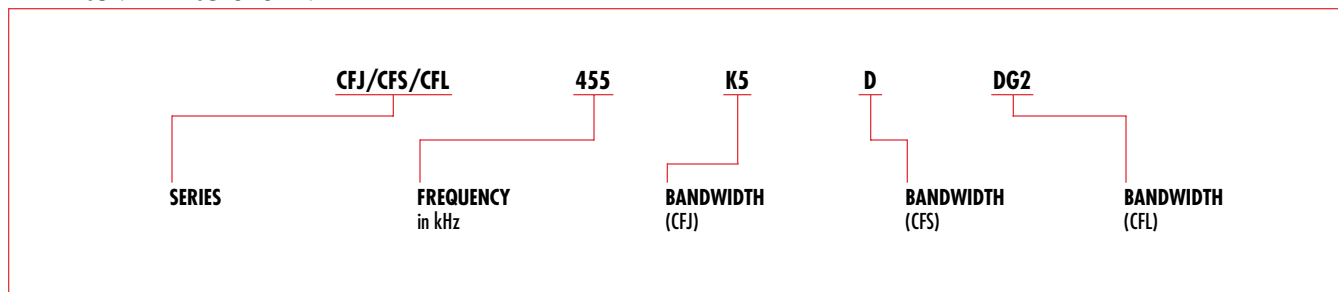

*Applicable in North American market only. *Applicable in European market only. For more detailed information regarding this product line in North America, see Catalog No. P-05-D. To receive additional information on Murata Products call 1-800-831-9172. For more detailed information regarding this product line in Europe, see Catalog No. POSE-8.

FILTERS

FOR COMMUNICATIONS EQUIPMENT—RESIN MOLDED, MULTI-ELEMENT—CFUS□Y/CFWS□Y SERIES



The CFUS□Y lines of ceramic filters are 4-element devices connected in ladder form while the CFWS□Y455 filters contain 6-elements. These highly selective filters are designed to address the G.D.T. characteristics required in digital communications. The excellent G.D.T. characteristics allow these filters to be utilized in areas such as the mobile cellular markets as well as a variety of stereo applications. Available in 450kHz and 455kHz versions.

DIMENSIONS: mm

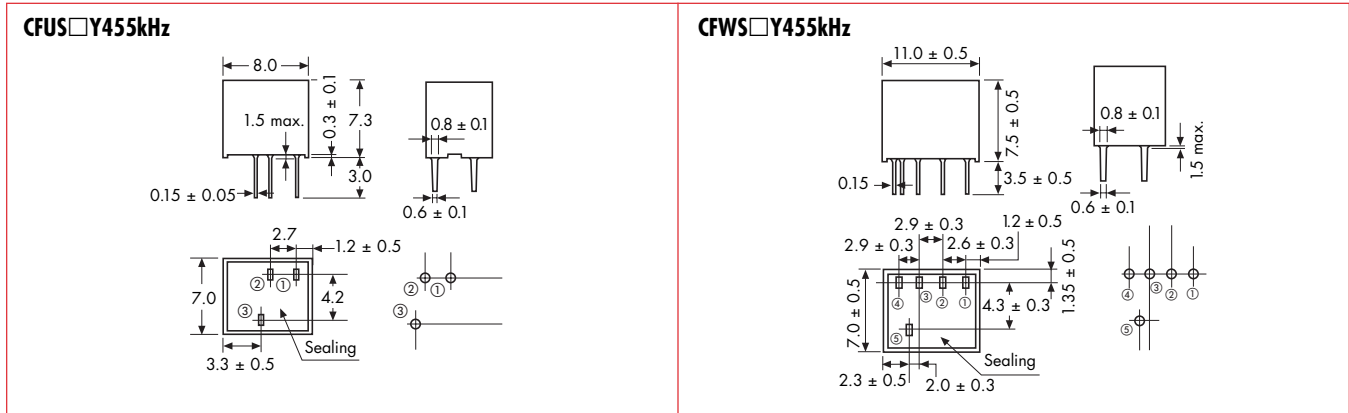

SPECIFICATIONS

Part Number	6dB Bandwidth (kHz) min.	Attenuation Bandwidth (kHz) max.	Stop Band Attenuation (dB) min	Insertion Loss (dB) max.	Ripple (dB) max.	Group Delay Time sec. max. (kHz)	Input /Output Impedance (Ω)
CFUS455BY	±15.0	±35	25	5.0	1.0	15μ (455 ± 10)	1.5k
CFUS455CY	±12.5	±30	25	6.0	1.0	15μ (455 ± 8.0)	1.5k
CFUS455DY	±10.0	±25	23	7.0	1.0	20μ (455 ± 7.0)	1.5k
CFUS455EY	±7.5	±20	23	8.0	1.0	20μ (455 ± 5.0)	1.5k
CFUS455FY	±6.0	±17.5	23	9.0	1.0	20μ (455 ± 4.0)	2.0k
CFUS455GY	±4.5	±15	23	10.0	1.0	20μ (455 ± 3.0)	2.0k
CFWS455BY	±15.0	±35	40 min.	6.0	1.0	30μ (455 ± 10)	1.5k
CFWS455CY	±12.5	±30	40 min.	7.0	1.0	30μ (455 ± 8.0)	1.5k
CFWS455DY	±10.0	±25	40 min.	8.0	1.0	30μ (455 ± 7.0)	1.5k
CFWS455EY	±7.5	±20	40 min.	9.0	1.0	30μ (455 ± 5.0)	1.5k
CFWS455FY	±6.0	±17.5	40 min.	10.0	1.0	40μ (455 ± 4.0)	2.0k
CFWS455GY	±4.5	±15	40 min.	11.0	1.0	40μ (455 ± 3.0)	2.0k

PART NUMBERING SYSTEM

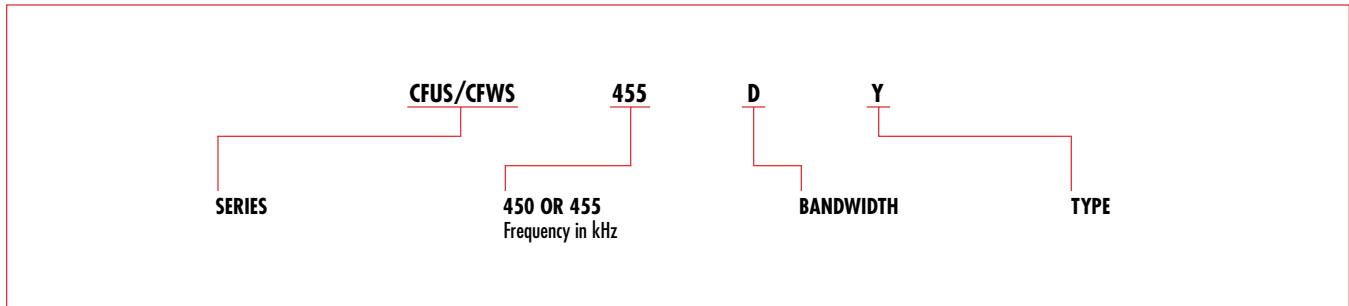

*Applicable in North American market only. ▼Applicable in European market only.
 For more detailed information regarding this product line in North America, see Catalog No. P-05-D. To receive additional information on Murata Products call 1-800-831-9172.
 For more detailed information regarding this product line in Europe, see Catalog No. P05E-8.

FILTERS

FILTERS

MULTI-ELEMENT, ULTRA MINIATURE, GDT FLAT CFUM□Y/CFWM□Y455kHz

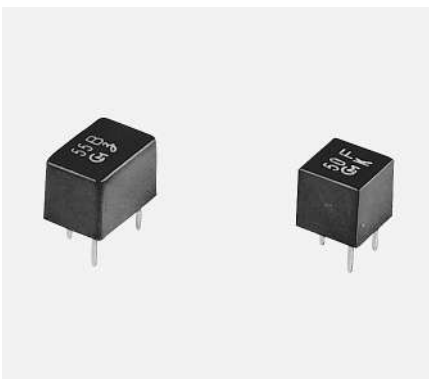

The CFUM□Y/CFWM□Y lines of ceramic filters are miniaturized versions of the CFUS□Y/CFWS□Y lines. These ultra-miniature versions consume approximately 40% less volume while still offering the same excellent G.D.T. characteristics as the CFUS□Y/CFWS□Y lines. This reduction in size makes these devices ideal for compact communication applications such as mobile telephones. Available in 450kHz and 455kHz versions.

DIMENSIONS: mm



SPECIFICATIONS

Part Number	6dB Bandwidth (kHz) min.	40dB Bandwidth (kHz) max.	Stop Band Attenuation (dB) min.	Insertion Loss (dB) max.	Group Delay Time sec. max. (kHz)	Input /Output Impedance (Ω)
CFUM455BY	±15	±35	25	5	15μ (455 ± 10.0)	1500
CFUM455CY	±12.5	±30	25	6	15μ (455 ± 8.0)	1500
CFUM455DY	±10	±25	23	7	20μ (455 ± 7.0)	1500
CFUM455EY	±7.5	±20	23	8	20μ (455 ± 5.0)	1500
CFUM455FY	±6.0	±17.5	23	9	20μ (455 ± 4.0)	2000
CFUM455GY	±4.5	±15	20	10	20μ (455 ± 3.0)	2000
Part Number	6dB Bandwidth (kHz) min.	50dB Bandwidth (kHz) max.	Stop Band Attenuation (dB) min.	Insertion Loss (dB) max.	Group Delay Time sec. max. (kHz)	Input /Output Impedance (Ω)
CFWM455BY	±15	±35	40	6	30μ (455 ± 10.0)	1500
CFWM455CY	±12.5	±30	40	7	30μ (455 ± 8.0)	1500
CFWM455DY	±10	±25	40	8	30μ (455 ± 7.0)	1500
CFWM455EY	±7.5	±20	40	9	30μ (455 ± 5.0)	1500
CFWM455FY	±6.0	±17.5	40	10	40μ (455 ± 4.0)	2000
CFWM455GY	±4.5	±15	40	11	40μ (455 ± 3.0)	2000

- CFUM455□Y is a miniaturized 4-element version of the conventional CFUS455□Y.
- CFWM455□Y is a miniaturized 4-element version of the conventional CFWS455□Y.
- **Note:** For safety purposes, connect the output of filters to the IF amplifier through a DC blocking capacitor. Avoid applying a direct current to the output of ceramic filters.

PART NUMBERING SYSTEM

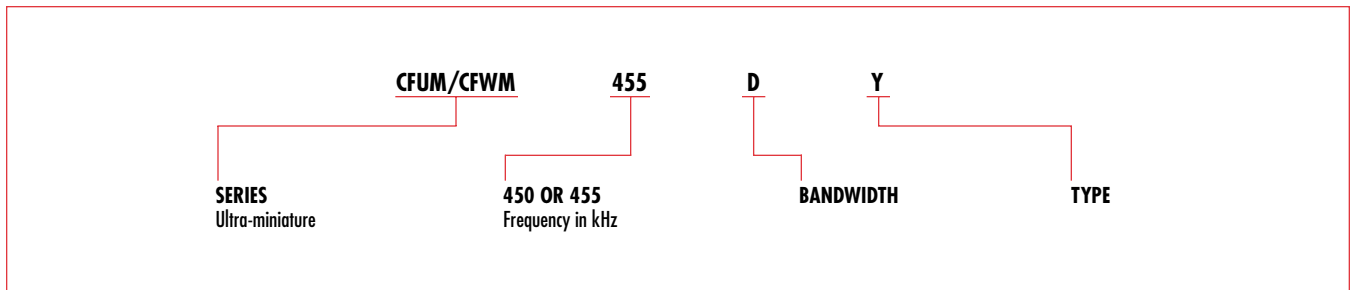

*Applicable in North American market only. *Applicable in European market only.
For more detailed information regarding this product line in North America, see Catalog No. P-05-D. To receive additional information on Murata Products call 1-800-831-9172.
For more detailed information regarding this product line in Europe, see Catalog No. POSE-8.

FILTERS

FOR COMMUNICATIONS EQUIPMENT—DISCRIMINATORS CDB/CDBC/CDBM455kHz

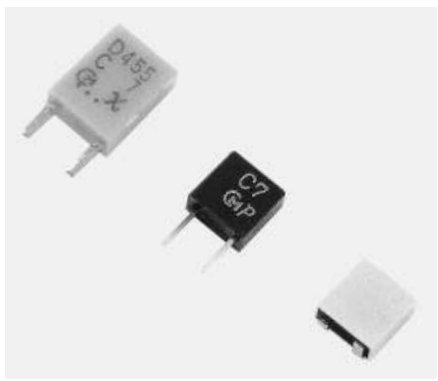

Ceramic discriminator consists of wide band piezoelectric resonator. It is ideal for mobile communication equipment due to its small size and light weight. Standard line includes products for a wide range of applications, from cordless telephones to cellular telephones, making non-adjustment and shrinking of the detection circuit possible.

Available in 450kHz and 455kHz versions.

FEATURES

- Small in size and light weight
- Realize non-adjustment in detection circuit
- High sensitivity and stability
- Wide range of standard products are available for various ICs
- Operating temperature range: -20°C to +80°C
Storage temperature range: -40°C to +85°C

DIMENSIONS: mm

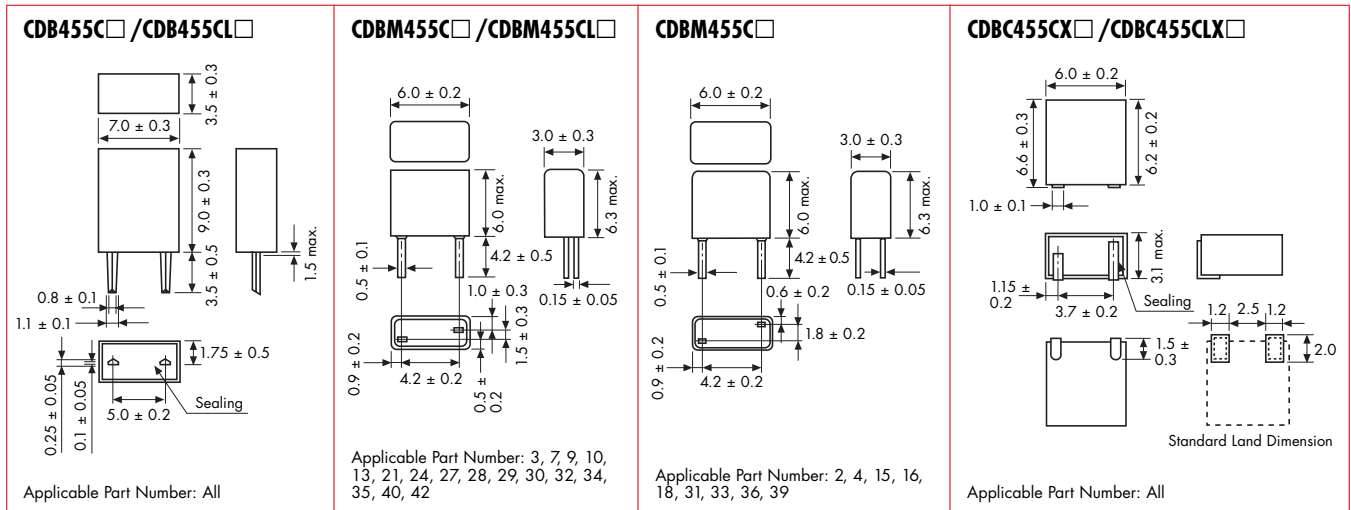

SPECIFICATIONS

Part Number / Characteristics	Recovered Audio		Distortion		IC	Application
	3dB Bandwidth (from 544kHz) min.	Output (at 455kHz)	(at 455kHz) max.	within 455 ± 8kHz		
CDB455C7*	±4.0	340 ± 60mV	2.5%	—	MC3357	Cordless Telephone, Communications Equipment
CDBC455CX7	±4.0	350 ± 60mV	3.0%	—		
CDB455C9*	±5.0	100mV min.	1.5%	—	NE604N	Cordless Telephone, Cellular Phone, Communications Equipment
CDBC455CX9	±4.0	120 ± 40mV	1.5%	—		
CDB455CL9	±15.0	70 ± 20mV	1.5%	3.5% max.	CXA1003BM	Cellular Phone, Communications Equipment
CDB455CL13*	±15.0	110 ± 30mV	1.5%	5.0% max.		
CDB455C16*	±4.0	185 ± 40mV	2.0%	—	MC3372	Cellular Phone, Cordless Telephone, Communications Equipment
CDBC455CX16	±4.0	175 ± 40mV	2.0%	—		
CDBM455C18	±3.0	180 ± 40mV	2.0%	—	MC3371	Cordless Telephone, Communications Equip.
CDB455C28*	±4.0	40 ± 20mV	3.0%	—	TA31142	Pager
CDB455C29*	±4.0	125 ± 30mV	2.5%	—	NE605	Cordless Telephone, Communications Equipment
CDBC455CX29	±4.0	100 ± 30mV	2.5%	—		
CDB455C34*	±4.0	65 ± 20mV	2.5%	—	MC13136	Cordless Telephone, Communications Equip.
CDBM455C36	±3.5	100 ± 25mV	3.5%	—	NE(SA)606, NE(SA)616	Cordless Telephone, Cellular Phone
CDBC455CLX36	±13.0	90 ± 30mV	2.5%	5.0% max.		
CDBM455C39	±4.0	85 ± 20mV	2.5%	—	NE(SA)607/617	Cordless Telephone
CDB455C42*	±4.0	40 ± 15mV	3.0%	—	TK14590, TK14591	Pager

*Also available in miniature package CDBM.

*Applicable in North American market only. *Applicable in European market only.

For more detailed information regarding this product line in North America, see Catalog No. P-05-D. To receive additional information on Murata Products call 1-800-831-9172.

For more detailed information regarding this product line in Europe, see Catalog No. P05E-8.