

Approved by:

Checked by:

Issued by:

SPECIFICATION

PRODUCT: SAW FILTER

MODEL: HDBF36A5D 2.3mm



SHOULDER ELECTRONICS LIMITED

1.SCOPE

SHOULDER's SAW filter series have broad line up products meeting all broadcast standard including NTSC,PAL and SECAM systems. These filters are composed of two interdigital transducers on a single-crystal, piezoelectrical chip. they are used in electronic equipments such as TV and so on.

2.Construction

2.1 Dimension and materials

Manufacturer's name : SHOULDER ELECTRONICS Co. LTD(CHINA)

Type: BF36A5D

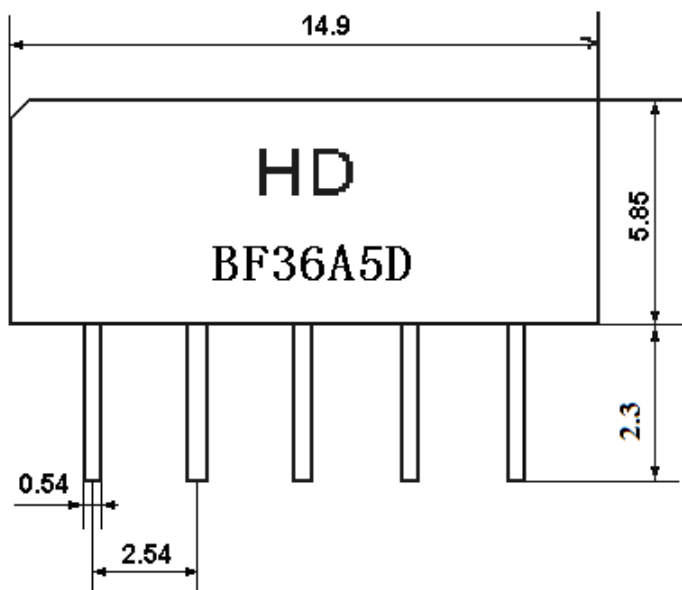
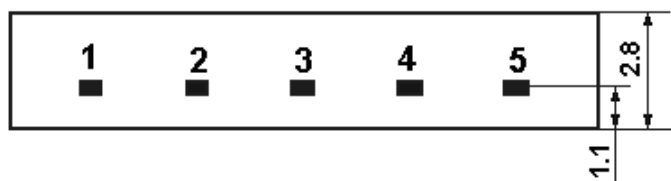

Unit : mm

- 1 Input
- 2 Switching input
- 3 Chip carrier - ground
- 4 Output
- 5 Output

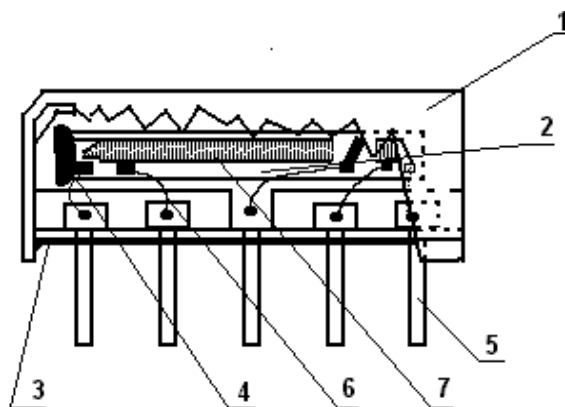

Components	Materials
1.Outer casing	PPS
2.Substrate	Lithium niobate
3.Base	Epoxy resin
4.Absorber	Epoxy resin
5.Lead	Cu alloy+Au plate
6.Bonding wire	AlSi alloy
7.Electrode	Al

3.1 Maximum Rating

DC voltage	VDC	12	V	Between any terminals
AC voltage	Vpp	10	V	Between any terminals

3.2 Electrical Characteristics

Characteristics of channel 1 (switching input pin 2 connected to pin 3)

Source impedance

$$Z_S=50\ \Omega$$

Load impedance

$$Z_L=2k\ \Omega //3pF$$

$$T_A=25^\circ C$$

Item	Freq	min	typ	max	
Center frequency	Fo	-	36.17	-	MHz
Insertion attenuation Reference level	36.17MHz	19.0	21.0	23.0	dB
Pass bandwidth	B1.5dB	7.4	7.7	8.0	MHz
	B3dB	7.7	8.0	8.3	MHz
	B10dB	8.6	8.9	9.2	MHz
	B30dB	8.8	9.4	10.0	MHz
Sidelobe	25.00~31.15MHz	33.0	40.0	-	dB
	41.15~42.0MHz	31.0	36.0	-	dB
	42.00~45.00MHz	34.0	41.0	-	dB
Reflected wave signal suppression 1.2 us ... 6.0 us after main pulse (test pulse 250 ns , carrier frequency 36.17 MHz)		42.0	50.0		dB
Group delay ripple (p-p) 32.25~40.05 MHz		-	50	-	ns
Temperature coefficient			-72		ppm/k

Characteristics of channel 2 (switching input pin 2 connected to pin 1)

Source impedance

$$Z_S=50\ \Omega$$

Load impedance

$$Z_L=2k\ \Omega //3pF$$

$$T_A=25^\circ C$$

Item	Freq	min	typ	max	
Center frequency	Fo	-	36.17	-	MHz
Insertion attenuation Reference level	36.17MHz	19.0	21.0	23.0	dB
Pass bandwidth	B1.5dB	6.4	6.7	7.0	MHz
	B3dB	6.7	7.0	7.3	MHz
	B10dB	7.7	8.0	8.3	MHz
	B30dB	7.9	8.5	9.1	MHz
Sidelobe	25.00~31.55MHz	33.0	40.0	-	dB
	40.75~45.00MHz	31.0	36.0	-	dB
Reflected wave signal suppression 1.2 us ... 6.0 us after main pulse (test pulse 250 ns , carrier frequency 36.17 MHz)		42.0	50.0		dB
Group delay ripple (p-p) 32.75~39.55 MHz		-	50	-	ns
Temperature coefficient			-72		ppm/k

3.3 Environmental Performance Characteristics

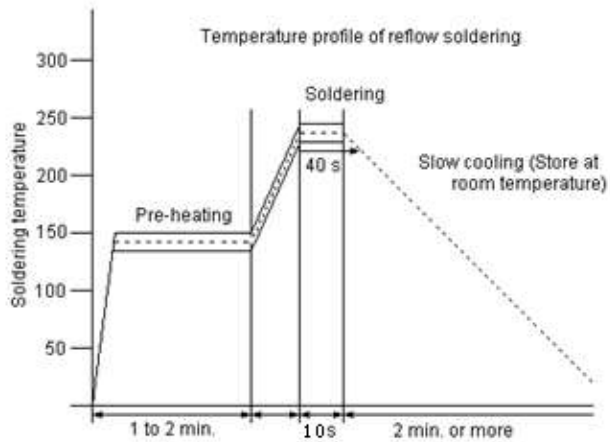
Item	Condition	Specifications																					
High temperature	The specimen shall be store at a temperature of $80\pm 2^{\circ}\text{C}$ for $96\pm 4\text{h}$. Then it shall be subjected to standard atmospheric conditions for 1h, after which measurement shall be made within 1h.	Mechanical characteristics and specifications in electrical characteristics shall be satisfied. There shall be no excessive change in appearance.																					
Low temperature	The specimen shall be store at a temperature of $-20\pm 3^{\circ}\text{C}$ for $96\pm 4\text{h}$. Then it shall be subjected to standard atmospheric conditions for 1h, after which measurement shall be made within 1h.																						
Humidity	The specimen shall be store at a temperature of $40\pm 2^{\circ}\text{C}$ with relative humidity of 90% to 96% for $96\pm 4\text{h}$. Then it shall be subjected to standard atmospheric conditions for 1h, after which measurement shall be made within 1h.																						
Thermal shock	<p>The specimen shall be subjected to 8 continuous cycles each as shown below. Then it shall be subjected to standard atmospheric conditions for 1h, after which measurement shall be made within 1h.</p> <table border="1" data-bbox="448 954 1018 1249"> <thead> <tr> <th></th> <th>Temperature</th> <th>Duration</th> </tr> </thead> <tbody> <tr> <td>1</td> <td>$+25^{\circ}\text{C} \Rightarrow -40^{\circ}\text{C}$</td> <td>0.5h</td> </tr> <tr> <td>2</td> <td>-40°C</td> <td>4h</td> </tr> <tr> <td>3</td> <td>$-40^{\circ}\text{C} \Rightarrow +85^{\circ}\text{C}$</td> <td>2h</td> </tr> <tr> <td>4</td> <td>$+85^{\circ}\text{C}$</td> <td>4h</td> </tr> <tr> <td>5</td> <td>$+85^{\circ}\text{C} \Rightarrow +25^{\circ}\text{C}$</td> <td>0.5h</td> </tr> <tr> <td>6</td> <td>$+25^{\circ}\text{C}$</td> <td>1h</td> </tr> </tbody> </table>			Temperature	Duration	1	$+25^{\circ}\text{C} \Rightarrow -40^{\circ}\text{C}$	0.5h	2	-40°C	4h	3	$-40^{\circ}\text{C} \Rightarrow +85^{\circ}\text{C}$	2h	4	$+85^{\circ}\text{C}$	4h	5	$+85^{\circ}\text{C} \Rightarrow +25^{\circ}\text{C}$	0.5h	6	$+25^{\circ}\text{C}$	1h
	Temperature		Duration																				
1	$+25^{\circ}\text{C} \Rightarrow -40^{\circ}\text{C}$		0.5h																				
2	-40°C	4h																					
3	$-40^{\circ}\text{C} \Rightarrow +85^{\circ}\text{C}$	2h																					
4	$+85^{\circ}\text{C}$	4h																					
5	$+85^{\circ}\text{C} \Rightarrow +25^{\circ}\text{C}$	0.5h																					
6	$+25^{\circ}\text{C}$	1h																					
Resistance to Soldering heat	<p>Reflow soldering method Peak: $255 \pm 5^{\circ}\text{C}$, $220 \pm 5^{\circ}\text{C}$, 40s At electrode temperature of the specimen.</p>  <p>The specimen shall be passed through the reflow furnace with the condition shown in the above profile for 1 time. The specimen shall be stored at standard atmospheric conditions for 1h, after which the</p>																						

	measurement shall be made. Test board shall be 1.6 mm thick. Base material shall be glass fabric base epoxy resin.	
Solder ability	Immerse the pins melt solder at 260°C+5/-0°C for 5 sec.	More then 95% of total area of the pins should be covered with solder

3.4 Mechanical Test

Items	Conditions	Specifications
Vibration	600-3300rpm amplitude 1.5mm 3 directions 2 H each	There shall be no damage.
Drop	On maple plate from 1 m high 3 times	
Lead pull	Pull with 1 kg force for 30 seconds	
Lead bend	90° bending with 500g weigh 2 times	

3.5 Voltage Discharge Test

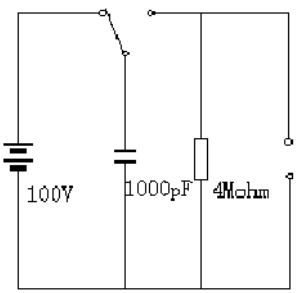
Item	Condition	Specifications
Surge	Between any two electrode 	There shall be no damage

3.6 Frequency response of channel 1:

►1: Transmission /M Log Mag 10.0 dB/

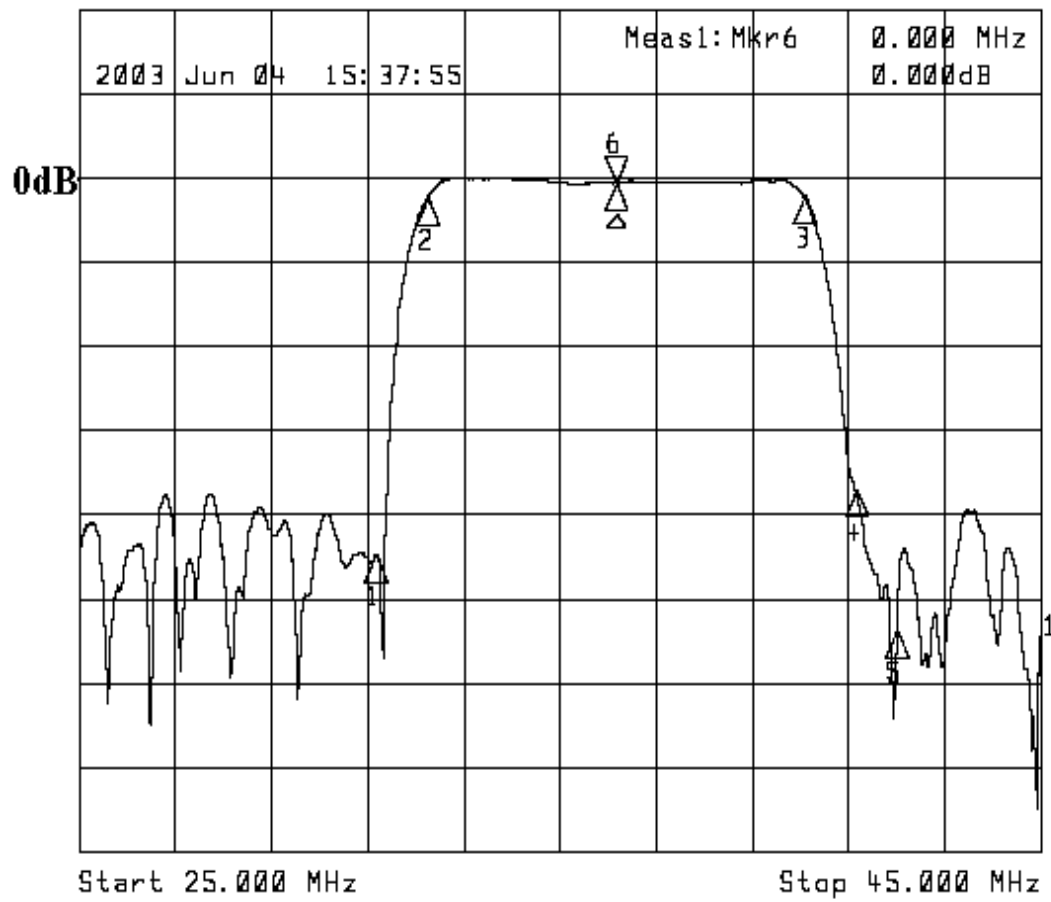

1: Mkr Δ (MHz)	dB	2: Mkr (MHz)	dB
1:	-5.0200	-44.327	
2:	-3.9200	-1.771	
3:	3.8800	-1.557	
4:	4.9800	-36.572	
5:	5.8300	-53.315	
6>	0.0000	0.000	

Frequency response of channel 2:

►1: Transmission /M Log Mag 10.0 dB/

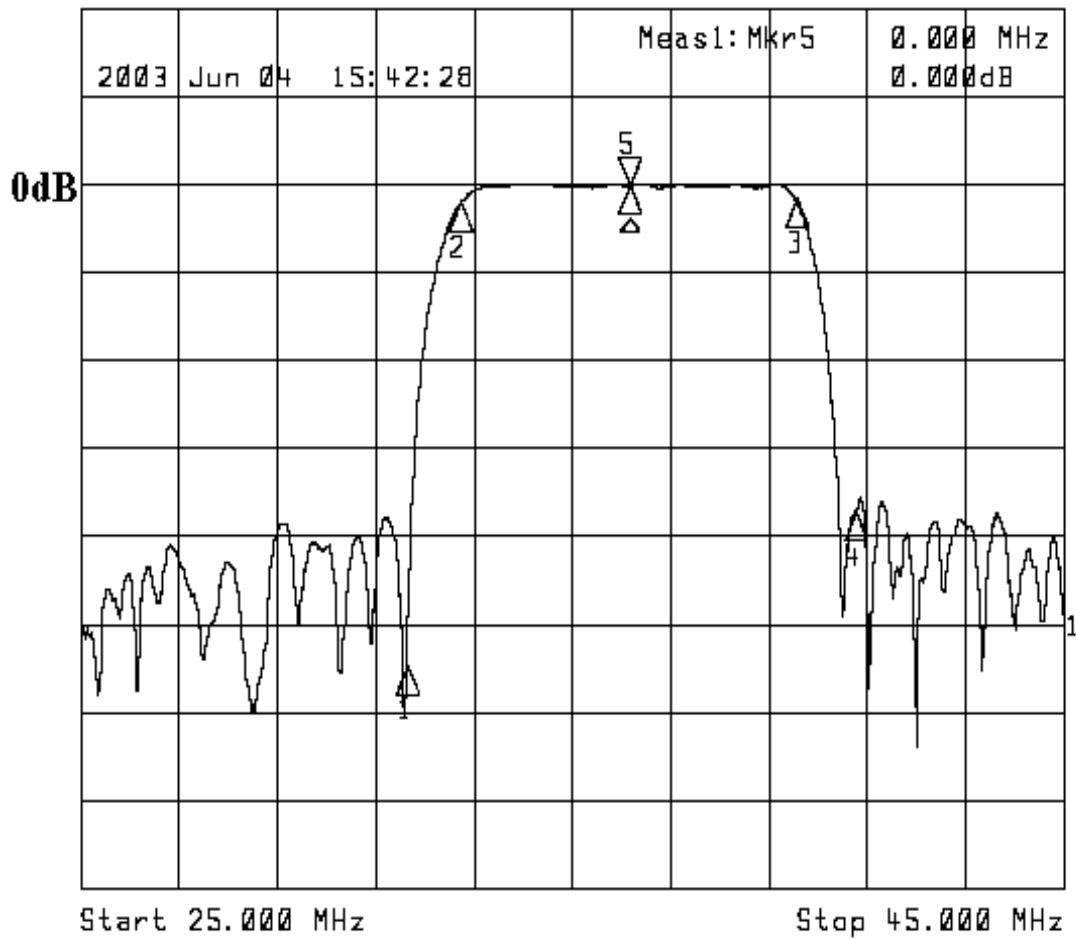

1: Mkr Δ (MHz)	dB	2: Mkr (MHz)	dB
1:	-4.5200	-54.774	
2:	-3.4400	-1.854	
3:	3.3800	-1.524	
4:	4.5800	-37.183	
5:	0.0000	0.000	