



T-SD-23

CRYSTAL CLOCK OSCILLATORS

KXO,386,KHO Series

■ Mechanical Features

Reading to be made one hour after completion of test at room temperature and humidity.

Shock resistance test	Let the time base module fall in a natural state on a hard wooden surface from a height of 50 cm three times. It must satisfy electrical requirements after testing.
Vibration resistance test	Apply vibrations with width of 1.5 mm and length of 1 minute at 10 to 55 Hz on X, Y, and Z axes of the time base module for two hours for a total of 6 hours. It must satisfy electrical requirements after testing.
Pin strength test	It must satisfy electrical requirements and also show no abnormality in appearance after application of a 1 kg load for 30 seconds in the direction of each pin. There should not be any incision in the pin after bending pin at the base at a 90° angle in one direction twice, and electrical requirements satisfied as well.
Solvent resistance test	Immerse in Freon TF, Freon TE, and IPA liquid (25°C with allowance of 5 degrees below and above the level) for 10 minutes. There should be no abnormality in reading after testing.
Resistance to ultrasonic washing	Ultrasonic washing at 28 to 31 kHz and 300W/20L in a liquid of Freon TF, Freon TE, and IPA for up to 30 seconds. Must satisfy electrical requirements after testing, as well as keep reading legible.

■ Environmental Features

Reading to be done two hours after testing at room temperature and humidity.

Solder heat resistance test	Soak pin 1 mm from tip of glass stand-off in solder bath at 280°C (with 10° allowance) for 10 seconds. Electrical requirements should be satisfied after testing.
Heat resistance test	Expose to temperature of 85° C for 500 hours. Frequency change after testing should be within above or below 10 ppm. Electrical requirements should also be satisfied.
Cold resistance test	expose to temperature of -40°C for 500 hours. Electrical requirements should be satisfied after testing.
Humidity resistance test	Expose to temperature of 85°C and humidity of 85% RH for 500 hours. Electrical requirements should be satisfied after testing; and no significant rusting found.
Thermal shock test	Apply thermal shock of 15 cycles of immersion in baths of 100°C and 0°C for 5 minutes each, with transfer time of within 10 seconds. Electrical requirements should be satisfied after testing.
Hermeticity test	Measurement with He leak detector should be under 5 x 10 ⁻⁷ atm. cc/ha. However, it must be measured after application of pressure of 10 kg/cm ² and, after three hours, exposure to air for 30 minutes. Otherwise, air bubbles should not be found when immersed in 75°C water for five minutes.

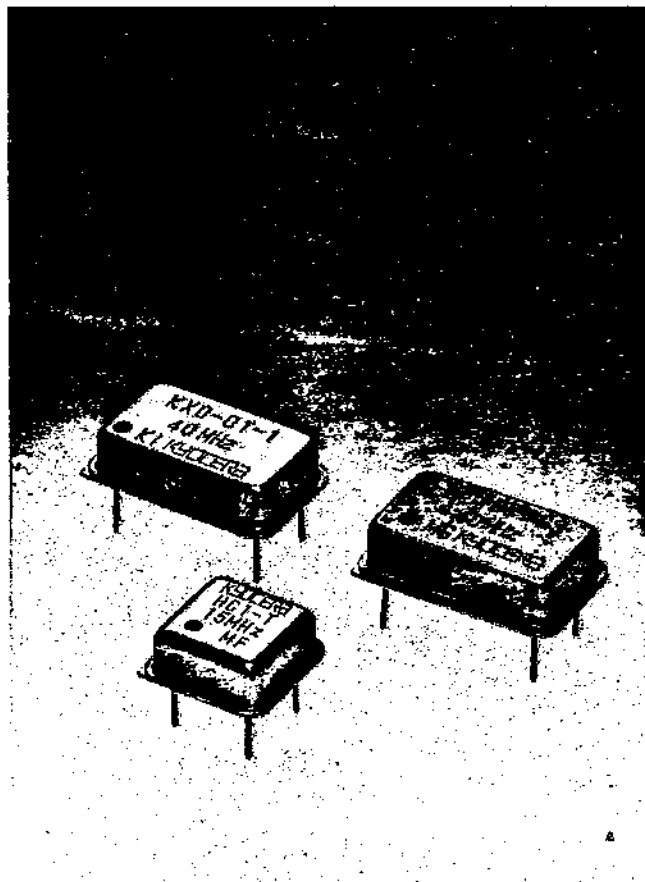

■ Current Consumption Chart

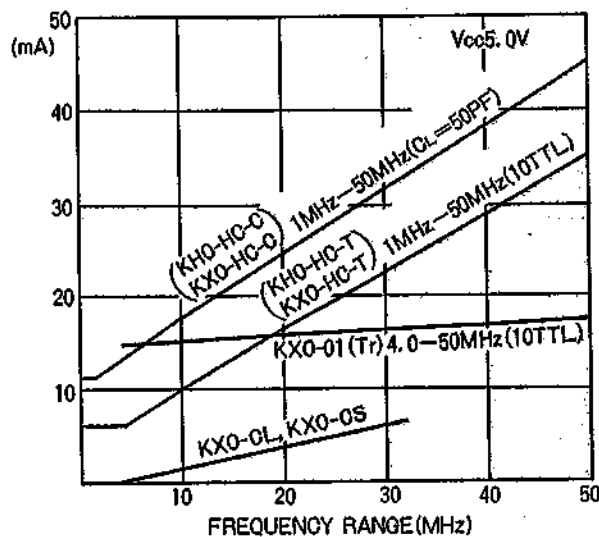

■ Marking

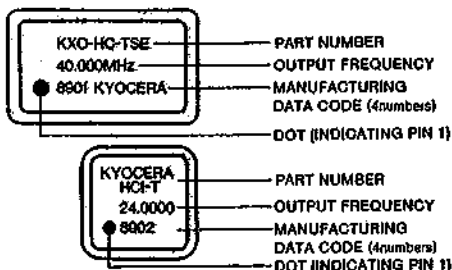

■ Manufacturing Date Code

Year	Week
89-1989	01-1st week
90-1990	02-2nd week
91-1991	10-10th week
92-1992	35-35th week

■ Dimensions

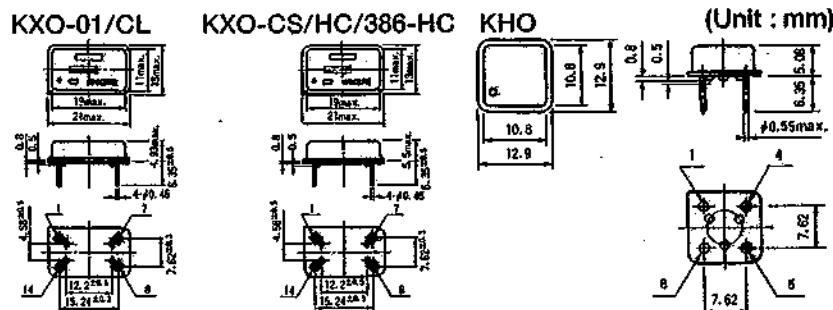

CRYSTAL CLOCK OSCILLATORS

CRYSTAL CLOCK OSCILLATORS

KXO Series

KXO-01 Series

Features

- 1) 14 pin DIP pin compatible
- 2) Wide frequency range (4MHz to 50MHz)
- 3) All metal package minimizes RF radiation and meets FCC EMI specifications
- 4) Solder dip pins

Specifications

Classification	Code	Rating	Unit	Remarks
Output frequency	f out	4M to 50M	Hz	
Frequency precision	Δ/f	0 : ± 50 1 : ± 100	ppm ppm	0 to +70°C 4.5V to 5.5V
Operating temperature range	Topr	0 to +70	°C	
Voltage	Vcc	6 \pm 0.5	V	
Electrical current consumption	Icc	Max 35	mA	
Output	Duty ratio	Sy	40 to 60	% 1.4V DC level
	"0" level	VOL	Max 0.4	V At I _{OL} =16mA
	"1" level	VOH	Min 2.4	V At I _{OH} =-400 μ A
	Rise and Fall time	T _r , T _f	Max 10	nsec guaranteed since Jan.1989
Fan out		1 to 10-TTL		

Test Circuit

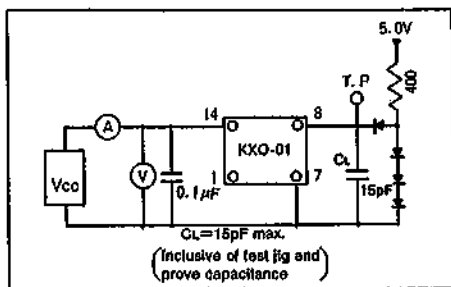

Shape of Output Wave

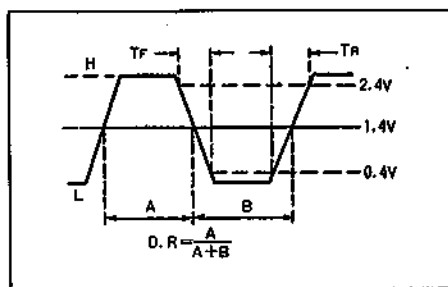

Pin Connection

1	N.C. ※
7	CASE GND
8	OUT PUT
14	+5.0V D.C.

Note: N.C. (=No connection)

KXO-01 Standard Frequency List (MHz)

4.000	16.000	28.63636
4.9152	16.257	30.000
8.000	19.6608	32.000
9.8304	20.000	40.000
10.000	24.000	
12.000	25.175	
14.31818	28.322	

How to Order

KXO-01-1-32.000M

①

②

③

- (1) Model name
- (2) Frequency precision
- (3) Frequency

CRYSTAL CLOCK OSCILLATORS

KXO Series

KXO-CL Series
■ Features

- 1) Lower wide frequency range (1KHz to 8MHz)
- 2) Low current consumption is ideal for battery operated equipment.
- 3) Binary output frequency is optional.
- 4) All metal package minimizes RF radiation and meets FCC EMI specifications.

■ Specifications

Classification	Code	Rating	Unit	Remarks	
Output frequency	f out	1K to 8M	Hz		
Frequency precision	Δ/f	0 : ± 50 1 : ± 100	ppm ppm	0 to +70°C 4.5V to 5.5V	
Operating temperature range	Topr	0 to 70	°C		
Voltage	Vcc	5 \pm 0.5	V		
Electrical current consumption	Icc	Max 4	mA		
Output	Duty ratio	Sy	40 to 60 45 to 55 (option)	% %	1/2 Vcc level Below 4MHz 1/2 Vcc level
	"0" level	Vol	Max 0.4	V	I _{OL} = 0.51mA
	"1" level	Voh	Min 4.6	V	I _{OH} = -80 μ A
	Rise and Fall time	Tr, Tf	Max 50	nsec	20%Vcc to 80%Vcc
Fan out		LS TTL 1gate			

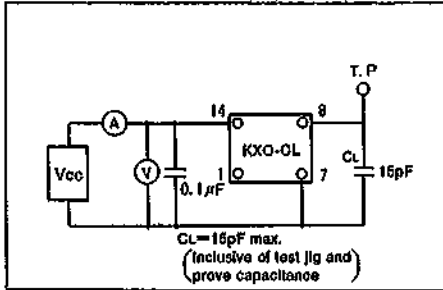
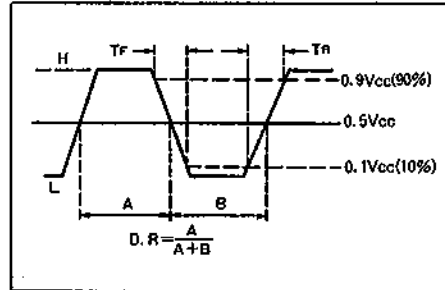
■ Test Circuit

■ Shape of Output Wave

■ Pin Connection

1	N.C.
7	CASE GND
8	OUT PUT
14	+5.0V D.C.

■ How to Order
K X O - C L 1 - S - 1.8432 M

① ② ③ ④

- (1) Model name
- (2) Frequency precision
- (3) Duty ratio Nil: 40 to 60% (1/2 Vcc level)
S: 45 to 55% (1/2 Vcc level)
- (4) Frequency

CRYSTAL CLOCK OSCILLATORS

KYOCERA NORTHWEST INC

19E D ■ 5293072 0000596 6 ■ T-50-23

CRYSTAL CLOCK OSCILLATORS

KXO Series

KXO-CS Series

Features

- 1) Wide frequency range (500KHz to 32MHz). 45 to 55% Duty is available (500KHz to 16MHz).
- 2) Stand-by function (low current consumption 0.1mA typical on Stand-by function).
- 3) At 16.0MHz, current consumption 3mA (typical) is realized by loading the newest H-CMOS IC.

Specifications

Classification	Code	Rating	Unit	Remarks	
Output frequency	f out	0.5M to 32M	Hz		
Frequency precision	$\Delta f/f$	0: ± 50 1: ± 100	ppm ppm	0 to +70 4.5V to 5.5V	
Operating temperature range	Topr	0 to 70°C	°C		
Voltage	Vcc	5 \pm 0.5	V		
Electrical current consumption	Icc	Max 5	mA	16MHz 25°C	
Output	Duty ratio	Sy	40 to 60	%	1/2 Vcc
			45 to 55 (option)	%	Below 16MHz 1/2 Vcc
	Rise and Fall time	T _r , T _f	Max 20	nsec	10%Vcc to 90%Vcc
	"0" level	V _{OL}	Max 10%Vcc	V	At 1.6mA
Input (Stand-by pin)	"1" level	V _{OH}	Min 90%Vcc	V	At -0.1mA
	"0" level	V _{IL}	Max 20%Vcc	V	
	"1" level	V _{IH}	Min 80%Vcc	V	
	"0" level	I _{IL}	Max -250	μ A	
	"1" level	I _{IH}	Max 10	μ A	
Standby current consumption	I _{stby}	Max 250	μ A		
Fan out		TTL 1gate		CMOS LEVEL OK	

Test Circuit

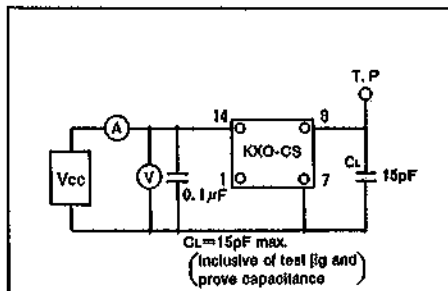

Shape of Output Wave

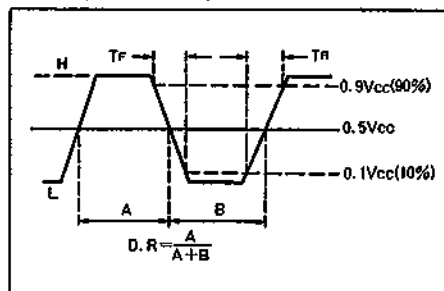

Pin Connection

1	N.C.
7	CASE GND
8	OUTPUT
14	+5.0V D.C.

Stand-by Function Chart

#1 Pin	#8 Pin
H or Open	Oscillation
L	No oscillation

How to Order

K X O - C S 1 - S E - 24.000 M

① ② ③ ④ ⑤

- (1) Model name
- (2) Frequency precision
- (3) Duty ratio Nil: 40 to 60% (1/2 Vcc level)
S: 45 to 55% (1/2 Vcc level)
- * (4) Stand-by function
E: with function
- (5) Frequency
- (*: Fixed)

CRYSTAL CLOCK OSCILLATORS

KXO Series

KXO-HC Series
■ Features

- 1) High Speed C-MOS clock oscillator. High Speed, Powerful drive level, Low current consumption.
- 2) Wide frequency range from 1MHz to 50MHz.
- 3) The output level is C-MOS compatible with its large noise margin and can also drive 10TTL ($I_{OL} = 16mA$). So, it has drive capability of almost all devices such as TTL, LS-TTL, S-TTL, C-MOS, HC-MOS, N-MOS, etc.
- 4) ENABLE/DISABLE FUNCTION (optional) is derived from a Tri-State output buffer controlled by logic levels on Pin 1. This function can provide a change of system timing as well as wired "OR" and easy system logic check by an alternate test oscillator.
- 5) 45/55 symmetry is available for less than 25MHz.

■ Specifications (KXO-HC-T/TTL COMPATIBLE)

Classification	Code	Rating	Unit	Remarks	
Output frequency	f_{out}	1M to 50M	Hz		
Frequency precision	$\Delta f/f$	0: ± 0.005 1: ± 0.01	%	0 to $\pm 70^\circ C$ 4.5V to 5.5V	
Operating temperature range	T_{opr}	0 to ± 70	$^\circ C$		
Voltage	$V_{CC(DD)}$	5 ± 0.5	V		
Electrical current consumption	$I_{CC(DD)}$	Max 35	mA	$f=25MHz$ $C_L=15pF$	
Output	Duty ratio	Sy	40 to 60	%	1.4V DC level
			45 to 55 (option)	%	Below 25MHz 1.4VDC level
	"0" level	V_{OL}	Max 0.4	V	$I_{OL}=At-16mA$
	"1" level	V_{OH}	Min $V_{CC}-0.2$	V	$I_{OH}=At-1mA$
	Rise and Fall time	T_R, T_F	Max 5	nsec	0.4V to 2.4V $C_L=15pF$ 10TTL load
Fan out		TTL 10gate			MOS level OK
Output enabled time		Max 100	nsec	Type E	
Output disabled time		Max 100	nsec	AT 3-STATE output	
Input current	I_{IH}	Max 10	μA	$V_{CC}=5.5V$	
	I_{IL}	Max -150	μA	$V_{CC}=5.5V$	
Input voltage	V_{IH}	Min 2.2	V		
	V_{IL}	Max 0.8	V		

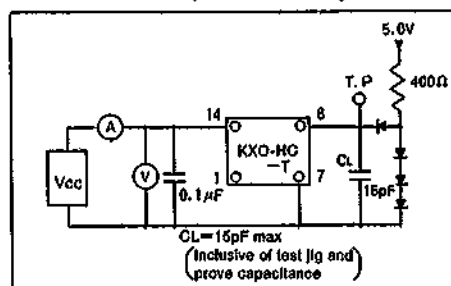
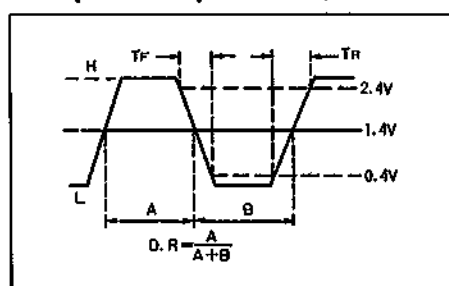
■ Test Circuit (KXO-HC-T)

■ Shape of Output Wave (KXO-HC-T)

■ Pin Connection

1	N.C. or CONTROL
7	CASE GND
8	OUT PUT
14	+5.0V D.C.

CRYSTAL CLOCK OSCILLATORS

KYOCERA NORTHWEST INC

19E D ■ 5293072 0000598 T ■ T-50-23

CRYSTAL CLOCK OSCILLATORS KXO Series

■ Specifications (KXO-HC-C/C-MOS COMPATIBLE)

Classification	Code	Rating	Unit	Remarks
Output frequency	f out	1M to 50M	Hz	
Frequency precision	$\Delta f/f$	0 : $\pm 0.005 (\pm 50)$ 1 : $\pm 0.01 (\pm 100)$	%(ppm) %(ppm)	0 to +70°C 4.5V to 5.5V
Operating temperature range	T _{opr}	0 to +70	°C	
Voltage	V _{CC(DD)}	5 \pm 0.5	V	
Electrical current consumption	I _{CC(DD)}	Max 35	mA	f=25MHz CL=50pF
Output	Duty ratio	40 to 60	%	1/2 V _{CC} level
		45 to 55 (option)	%	Below 25MHz 1/2 V _{CC} level
	"0" level	Max 0.4	V	I _{OL} =At16mA
	"1" level	Min V _{CC} -0.4	V	I _{OHI} =At-1mA
	Rise and Fall time	Max 10	nsec	10%V _{DD} to 90%V _{DD} CL=50pF
Output enabled time		Max 100	nsec	Type E
Output disabled time		Max 100	nsec	AT 3-STATE output
Input current	I _{IH}	Max 10	μ A	V _{CC} =5.5V
	I _{IL}	Max -150	μ A	V _{CC} =5.5V
Input voltage	V _{IH}	Min 2.2	V	
	V _{IL}	Max 0.8	V	

■ Test Circuit (KXO-HC-C)

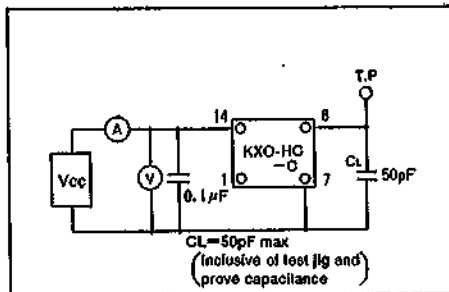

■ Shape of Output Wave (KXO-HC-C)

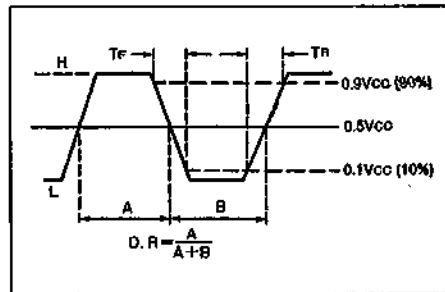

■ Pin Connection

1	N.C. or CONTROL
7	CASE GND
8	OUT PUT
14	+5.0V D.C.

■ Enable/Disable Function Chart (E specification)

#1 PIN	#8 PIN
H or OPEN	Oscillation
L	High impedance

■ KXO-HC Standard Frequency List (MHz)

1.8432	7.3728	24.8832
2.0000	12.0000	30.0000
3.0000	14.7456	32.0000
3.6864	16.0000	40.0000
4.0000	20.0000	50.0000
6.0000	24.0000	

■ How to Order

K X O - H C 1 - T S E - 32.000 M

① ② ③ ④ ⑤ ⑥

- (1) Model name
- (2) Frequency precision
- (3) Output level T: TTL compatible
 C: C-MOS compatible
- (4) Duty ratio Nil: 40 to 60%
 S: 45 to 55%
- (5) Enable/Disable function Nil: without function
 E: with function
- (6) Frequency

CRYSTAL CLOCK OSCILLATORS

386 Series

386 - HC Series
■ Features

- 1) World's only clock oscillator specifically designed to meet the rigorous timing demands of the powerful 80386.
- 2) Capable of driving the 80386 and the surrounding LSI devices (80387, 82380, 82385) at loads of up to 150pF.
- 3) Replaces existing clock generator and/or buffer chips providing a cost and space savings.
- 4) ENABLE/DISABLE FUNCTION is optional.
- 5) 45/55 symmetry for all standard frequencies even at 150pF loads. (50MHz up to 80pF.)

■ Specifications

Classification		Code	Rating	Unit	Remarks
Output frequency		f_{out}	12.0 to 40.0 40.1 to 50.0	MHz MHz	$C_L=150pF$ Max $C_L=80pF$ Max
Frequency precision		Δ/f	1 : ± 100	ppm	0 to 70°C 4.5 to 5.5V
Operating temperature range		T_{opr}	0 to +70	°C	
Storage temperature range			-55 to +125	°C	
Voltage		$V_{cc(oper)}$	6 ± 0.25	V	
Electrical current consumption		$I_{cc(oper)}$	Max 65	mA	$f=40MHz$ $C_L=150pF$
Output	Load capacitance	C_L	150 80	pF pF	$f=12.0MHz$ to 40.0MHz $f=40.1MHz$ to 50.0MHz
	Duty ratio	Sy	45 to 55	%	$1/2 V_{cc}$ level
	"0" level	V_{OL}	Max 0.5	V	$I_{OL}=At 12mA$
	"1" level	V_{OH}	Min $V_{cc}-0.4$	V	$I_{OH}=At -1mA$
	Rise and Fall time	T_r, T_f	(On clock time table)		nS
Output enabled time			Max 100	nsec	Type E
Output disabled time			Max 100	nsec	3-STATE
Input current		I_{IH} I_{IL}	Max 10 Max -150	μA μA	$V_{cc}=5.25V$ $V_{cc}=5.25V$
Input voltage		V_{IH} V_{IL}	Min 2.2 Max 0.8	V V	

■ Clock Time Table (32MHz, 40MHz)

Frequency	32MHz		40MHz	
	Min.	Max.	Min.	Max.
Clock time (nS)				
Clock high time t_{2a}	9	—	8	—
Clock high time t_{2b}	5	—	5	—
Clock low time t_{3a}	9	—	8	—
Clock low time t_{3b}	7	—	6	—
Clock fall time t_4	—	7.5	—	8
Clock rise time t_5	—	7.5	—	8

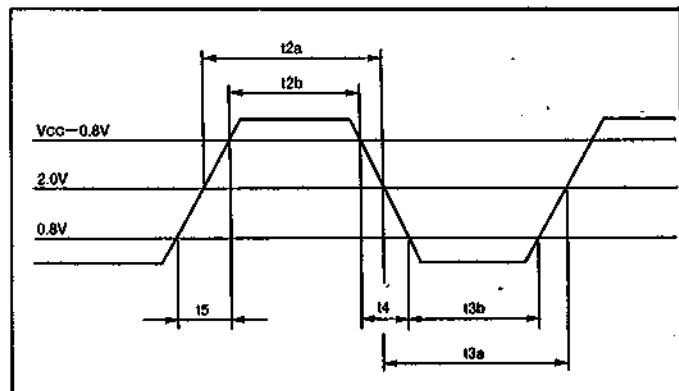
■ Shape of Output Wave (32MHz, 40MHz)

CRYSTAL CLOCK OSCILLATORS
386 Series

■ Clock Time Table (50MHz)

Frequency	50MHz	
	Min.	Max.
Clock time (nS)		
Clock high time t2a	7	—
Clock high time t2b	4	—
Clock low time t3a	7	—
Clock low time t3b	5	—
Clock fall time t4	—	7
Clock rise time t5	—	7

■ Shape of Output Wave (50MHz)

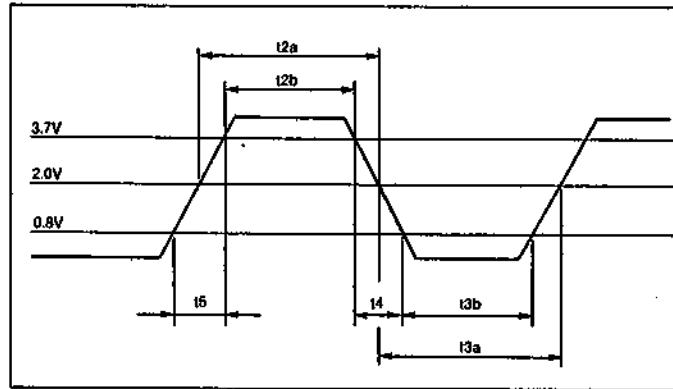

■ Test Circuit

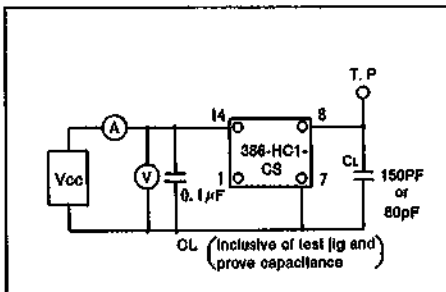

■ Load Capacitance

Frequency	Capacitance (Max.)
32MHz, 40MHz	150pF
50MHz	80pF

■ Enable/Disable Function Chart (E specification)

#1 Pin	#8 Pin
H or Open	Oscillation
L	High impedance

■ Pin Connection

1	N.C. OR CONTROL
7	GND
8	OUTPUT
14	+5Vcc

■ How to Order

3 8 6 - H C 1 - C S E - 40.000 M

① ② ③ ④ ⑤ ⑥

(1) Model name

(2) Frequency precision

* (3) Output level C: C-MOS compatible

* (4) Duty ratio S: 45 to 55%

(5) Enable/Disable function Nil: without function
E: with function

(6) Frequency

(*: Fixed)

CRYSTAL CLOCK OSCILLATORS

KHO Series

KHO-HC Series

■ **Features**

- 1) High Speed C-MOS clock oscillator. All functions of KXO-HC series are condensed into a half-inch size (8 pin DIP).
- 2) Very wide frequency (1MHz to 50MHz) for half-inch size clock oscillator.
- 3) Enable/Disable function is optional.
- 4) 45/55 symmetry is available for less than 25MHz.

■ **Specifications (KHO-HC-T/TTL COMPATIBLE)**

Classification		Code	Rating	Unit	Remarks
Output frequency		f out	1M to 50M	Hz	
Frequency precision		Δ/f	0 : ± 50 1 : ± 100	ppm ppm	0 to 70°C 4.5V to 5.5V
Operating temperature range		Topr	0 to + 70	°C	
Voltage		Vcc(DD)	5 \pm 0.5	V	
Electrical current consumption		Icc (DD)	Max 35	mA	f=25MHz CL=15pF · 10 TTL load
Output	Duty ratio	Sy	40 to 60	%	1.4V DC level
	"0" level	VOL	45 to 55 (option) Max 0.4	% V	Below 25MHz 1.4V DC level IOL=At 16mA
	"1" level	VOH	Min Vcc-0.2	V	Ioh=At -1mA
	Rise and Fall time	Tr, Tf	Max 5	nsec	0.4V to 2.4V CL=15pF IOTTL Load
Fan out			TTL 10gate		MOS level OK
Output enabled time			Max 100	nsec	Type E
Output disabled time			Max 100	nsec	At 3-State Output
Input current		Iih Iil	Max 10 Max -150	μ A μ A	Vcc=5.5V Vcc=5.5V
Input voltage		Vih Vil	Min 2.2 Max 0.8	V V	

■ **Test Circuit (KHO-HC-T)**

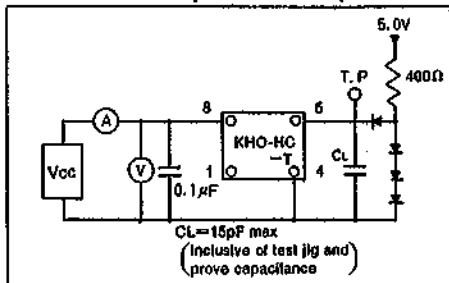

■ **Shape of Output Wave (KHO-HC-T)**

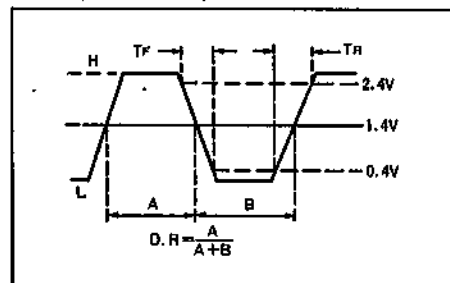

■ **Pin Connection**

1	N.C. or CONTROL
4	CASE GND
5	OUT PUT
8	+5.0V D.C.

CRYSTAL CLOCK OSCILLATORS

KYOCERA NORTHWEST INC

19E D

5293072 0000602 8

T-50-23

CRYSTAL CLOCK OSCILLATORS

KHO Series

Specifications (KHO-HC-C/C-MOS COMPATIBLE)

Classification	Code	Rating	Unit	Remarks
Output frequency	f_{out}	1M to 50M	Hz	
Frequency precision	Δ/f	0 : ± 50 1 : ± 100	ppm ppm	0 to $\pm 70^\circ\text{C}$ 4.5V to 5.5V
Operating temperature range	T_{opr}	0 to $+70$	$^\circ\text{C}$	
Voltage	$V_{cc(0)}$	5 ± 0.5	V	
Electrical current consumption	$I_{cc(0)}$	Max 35	mA	$f=25\text{MHz}$ $CL=60\text{pF}$
Output	Duty ratio	40 to 60	%	$\frac{1}{2}V_{cc}$ level
		45 to 55 (option)	%	Below 25MHz $\frac{1}{2}V_{cc}$ level
	"0" level	Max 0.4	V	$I_{OL}=At$ 16mA
	"1" level	Min $V_{cc}-0.4$	V	$I_{OH}=At$ 1mA
	Rise and Fall time	Max 10	nsec	10% V_{cc} to 90% V_{cc} $CL=50\text{pF}$
Output enabled time		Max 100	nsec	Type E
Output disabled time		Max 100	nsec	AT 3-STATE output
Input current	I_{IH}	Max 10	μA	$V_{cc}=5.5\text{V}$
	I_{IL}	Max -150	μA	$V_{cc}=5.5\text{V}$
Input voltage	V_{IH}	Min 2.2	V	
	V_{IL}	Max 0.8	V	

Test Circuit (KHO-HC-C)

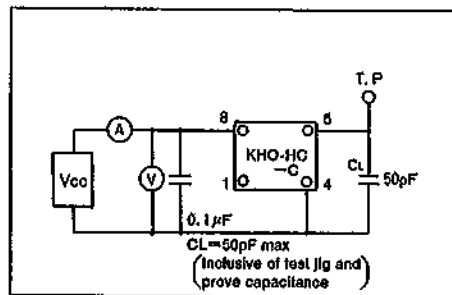

Shape of Output Wave (KHO-HC-C)

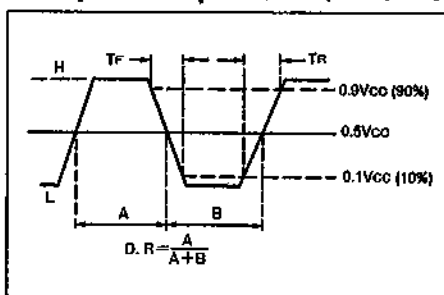

Pin Connection

1	N.C. or CONTROL
4	CASE GND
5	OUT PUT
8	+5.0V D.C.

Enable/Disable Function Chart (E specification)

#1 PIN	#5 PIN
H or OPEN	Oscillation
L	High impedance

KHO-HC Standard Frequency List (MHz)

1.8432	20.0000	32.0000
3.6864	21.0526	40.0000
7.3728	24.0000	48.0000
10.0000	25.1750	50.0000
14.7456	28.3220	
15.0000	28.63636	

How to Order

KHO-HC1-TSE-50.000M

① ② ③ ④ ⑤ ⑥

(1) Model name

(2) Frequency precision

(3) Output level T: TTL compatible
C: C-MOS compatible

(4) Duty ratio Nil: 40 to 60%
S: 45 to 55%

(5) Enable/Disable function Nil: without function
E: with function

(6) Frequency