

## Specification for Speaker

Model No.	VS3257R8F500P1	Drawing No.	VS20221123018
Customer			

### SPEC

NO.	Items	Specification	Test Condition
1	Impedance	8Ω ±15%	at 1Vrms,1kHz
2	Resonant Fr. (fo)	500Hz±20%	
3	Frequency Range	F0-20KHz	
4	Rated Power	1W	
5	Max Power	1.5W	
6	S.P.L.	88dB±3dB	(0.1W/0.1M at 0.6,0.8,1.0,1.2kHz Ave)
7	Distortion	<10% Max.	at 2kHz/2Vrms
8	Sweep Test	must be normal	at sine wave 2.83 V
9	Load Test	after test meet item 8	rated white noise power, 96 Hrs.
10	Heat Test	after test meet item 8	+60±2℃ 20~50% 96Hrs.
11	Cold Test	after test meet item 8	-20±3℃ 96Hrs.
12	Humidity Test	after test meet item 8	+40±2℃,90~95% 96Hrs.
13	Weight	8.3±5%g	
14	Polarity Test	with positive D.C. voltage to (+) terminal, the cone shall move forward.	
15	Note	IP65	

### Frequency Response Curve

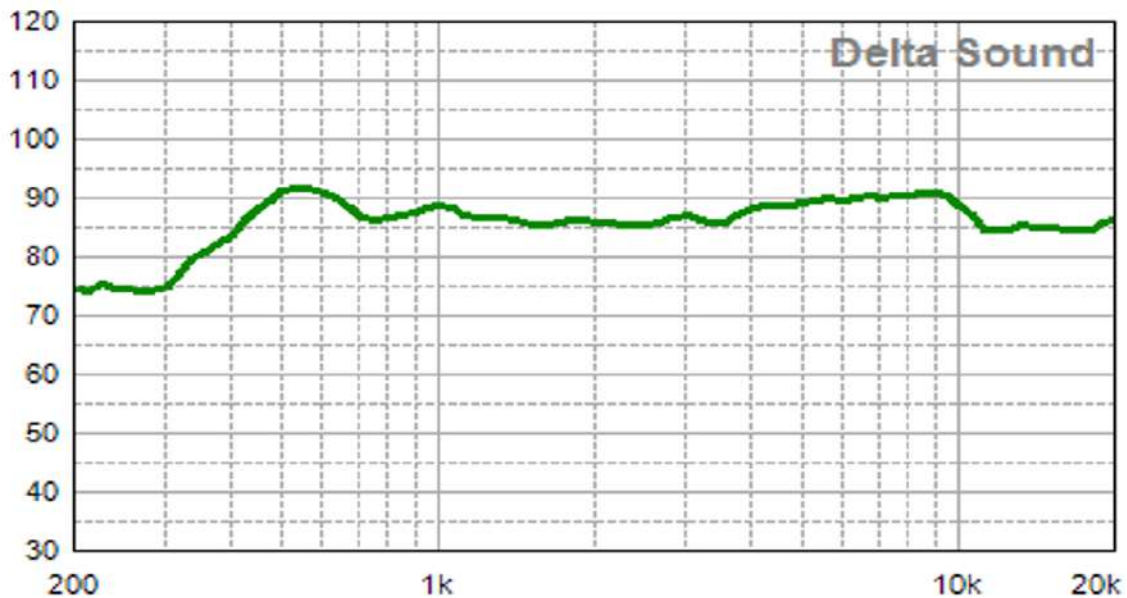

# Specification for Speaker

Model No. VS3257R8F500P1

Drawing No. VS20221123018

Dimensions:

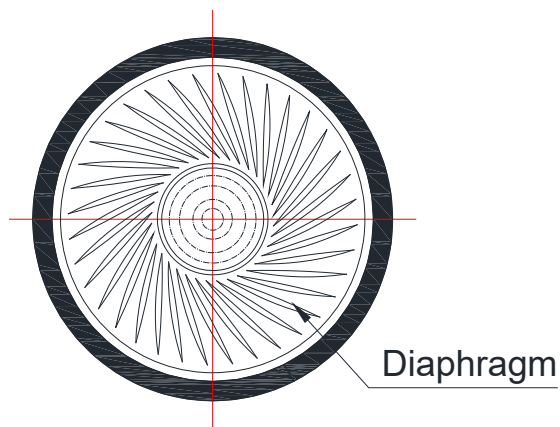
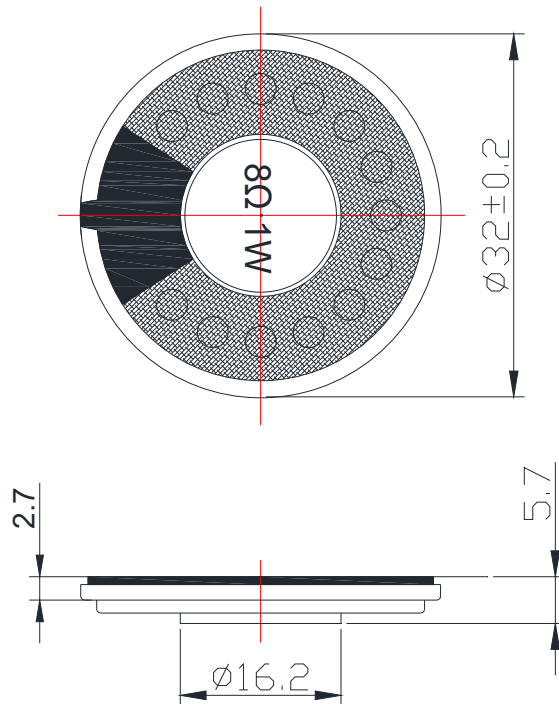

Unit : mm

Tolerance :  $\pm 0.2$