

Specification for Speaker

Model No.	VS4050R8F400P05WP	Drawing No.	VS20200426012
Customer			

SPEC

NO.	Items	Specification	Test Condition
1	Impedance	8Ω ±15%	at 1Vrms,0.8kHz
2	Resonant Fr. (fo)	400Hz±20%	
3	Frequency Range	f0-5KHz	
4	Rated Power	0.5W	
5	Max Power	1.0W	
6	S.P.L.	89dB±3dB	(0.1W/0.1M at0.8,1.0,1.2,1.5kHz Ave)
7	Distortion	<5% Max.	at 2kHz/2Vrms
8	Sweep Test	must be normal	at sine wave 2V
9	Load Test	after test meet item 8	rated white noise power, 96 Hrs.
10	Heat Test	after test meet item 8	+50±2°C 20~50% 96Hrs.
11	Cold Test	after test meet item 8	-30±3°C 96Hrs.
12	Humidity Test	after test meet item 8	+40±2°C,90~95% 96Hrs.
13	Weight	11±5%g	
14	Polarity Test	with positive D.C. voltage to (+) terminal, the cone shall move forward.	
15	Waterproof	IP65	

Frequency Response Curve

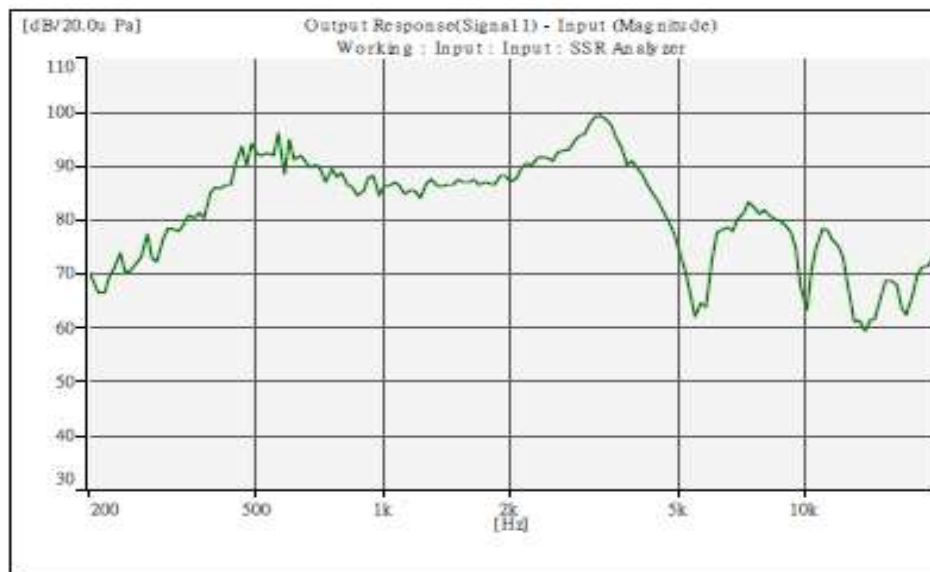

Specification for Speaker

Model No. VS4050R8F400P05WP

Drawing No. VS20200426012

Dimensions:

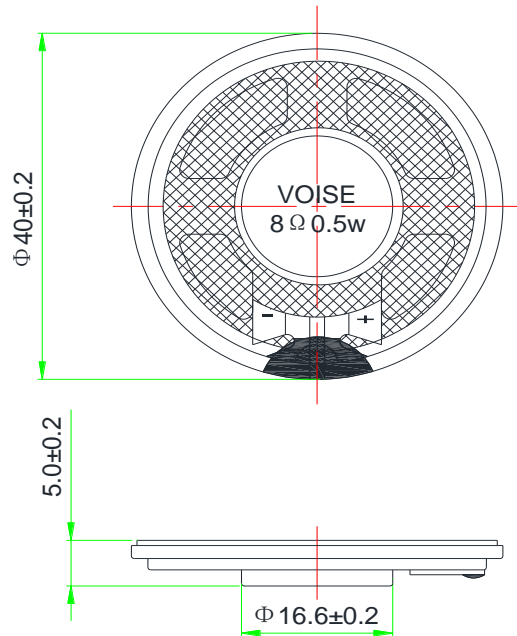

Unit : mm
Tolerance : ± 0.2